



**SURTEX**  
INSTRUMENTS

*Crafted to Excellence*







# SURTEX INSTRUMENTS

*Crafted to Excellence*

### • INTRODUCTION TO THE CATALOGUE

Thank you for your interest in Surtex Oral, Maxillofacial and ENT Instruments. We remain committed to providing the highest quality products and customer service.

In this special catalogue you will find a comprehensive range of Oral, Maxillofacial and ENT Instruments, which have been developed following detailed consultation with leading Oral, Maxillofacial and ENT surgeons. These instruments in conjunction with Surtex General Instruments provides complete solution for oral, maxillofacial, otology, rhinology, rhinoplasty, tonsillectomy and tracheotomy surgeries.

We appreciate your patronage and look forward to a successful relationship with you.

### • ABOUT SURTEX INSTRUMENTS

**Surtex Instruments** is a privately owned medical technology company dedicated to innovation and excellence in crafting of surgical instruments. The company started as a specialist in reconstructive surgery instruments and based on its success and innovative drive gradually expanded to cover a vast range of surgical instruments.

We now manufacture over 8,000 surgical instruments and offer innovative solutions in trauma, gynecology, cardiovascular, microsurgery and dental surgery. All our products are available to view online where you can download our entire range of catalogues or request a printed version.

### • SURTEX QUALITY STANDARDS

In European Union medical devices are subject to a series of uniform laws and the EC directive places rigid demands on surgical instruments. Surtex Instruments is proud to claim that we have always surpassed the legal requirements to ensure that each instrument reaching the surgeons hand is indeed a testament to surgical craftsmanship.

We are **BS EN ISO 13485:2012/ISO 9001:2008 (SGS UK)** certified and **CE** approved to ensure compliance with the standards defined in line with medical devices directive **93/42/EEC**.



### WHY IS SURTEX FOCUSED ON INSTRUMENTS QUALITY?

Surgeons are highly talented and skilled individuals. They operate under significant time constraints and are required to make split second decisions while performing complex operations. At Surtex we understand that in such a scenario the surgeon requires tools that are not just fit for the purpose but are reliable, dependable and crafted by a company that has a track record for relentless pursuit for excellence in the making of surgical instruments.



### • AFFORDABLE QUALITY

Surgical instruments represent a significant proportion of hospital's total assets. Hospitals and health centers are often required to minimize costs of surgical instruments without impacting quality or patient's health. Decision makers tend to respond via group purchasing contracts & multiple quotes to shop around for the lowest price. However this approach has significant drawbacks as numerous instrument companies have focused towards competing on price alone with a disregard towards instruments quality while claiming their instruments to be guaranteed and free of defect.

The outcome for the buyer being a perceived notion of a quality instrument, which is actually little more than a knock-off and delivers only poor value for money.

At **Surtex Instruments** our success has been based on helping customers navigate successfully through the instrument procurement process by identifying real value for money through fair comparison. We believe that quality should be affordable and you should not pay too much for over priced brands and neither should you pay too much for a low quality instrument.

### • LIFE TIME WARRANTY

We encourage our customers to calculate lifetime costs prior to making purchase decisions and investing in surgical instruments.

**Surtex Instruments** are guaranteed for life\* against manufacturing defects of material and workmanship. This means we will repair or replace free of charge any surgical instrument that does not meet its functional requirements when used for its intended purpose and maintained properly.



\*Conditions apply.



**SURTEX**  
INSTRUMENTS

*Crafted to Excellence*

## OUR PRODUCT BRANDS



A new dimension in cutting and dissecting performance. Our class leading integral self-sharpening technology standard on all Surtex scissors enabling precise cutting with minimum force even after pro-longed use.



These Surtex premium scissors feature finely ground micro serrations along one blade of the scissor preventing tissue slippage. The ultra sharp edge of the other blade cuts through the tissue precisely and atraumatically.



Instruments with this symbol benefit from tungsten carbide (TC) inserts expertly bonded on the cutting edge of the instrument. This material is harder than stainless steel and enables the instruments to last up to 6 times longer than standard instruments.



A true craftsmanship masterpiece and surgeons favourite. These are the best scissors in our range and combine the features of SuperEdge™ & UltraCut™ into a perfect pair of scissors that is precise, durable and reliable.



The only choice when the perfect grip matters. Utilising Creep Feed technology individual teeth are grinded into hard wear resistant tungsten carbide (TC). The result is super sharp teeth with well-defined point and inserts with impeccable gripping properties and instruments that last up to 6 times longer.



These instruments have jaws, which are coated with diamond dust resulting in improved gripping enabling superior manipulation of sutures, needles and tissues.



Our specially designed high strength fibre grip handles resulting in lightweight instruments. These ergonomic handles provide the surgeon with excellent feel, better grip, reduced shock, and less hand fatigue.



Surtex ENT diagnostic and anaesthesia instruments featuring direct bulb illumination of xenon grade bulbs.



This range features distal fibre optic to carry light from xenon bulb allowing cold illumination on operating site in our ENT diagnostics and anaesthesia instruments.



Premium grade ENT diagnostics and anaesthesia instruments combining features of distal fibre optic technology and ultra bright LED illumination ensuring the best in clear vision of operating site.



## CURRENT REFERENCE STANDARDS FOR SURTEX PRODUCTS

STANDARDS	CONTENTS OF THE STANDARD
BS EN ISO 9001:2008	Quality Management Systems certification standard.
BS EN ISO 13485:2003	Medical Devices – Quality Management Systems certification standard.
MDD 93/42/EEC, Annex II, Section 3.2	Medical Device Directive, 'EC Declaration of Conformity' (full quality assurance system).
MDD 93/42/EEC, Annex I	Essential Requirements for Medical Devices.
BS EN ISO 7153-1:2001 (BS 5194:Part 1:1991)	Surgical Instruments – Metallic materials part 1 - Stainless Steel
BS 5194:Part 2:1989	Specification for instruments with pivot joints (excluding cutting instruments)
BS 5194:Part 3:1985	Specification for Dissecting Forceps
BS 5194:Part 4:1985	Specification for scissors, shears, and other jointed cutting instruments
ISO 7151:1988	Surgical instruments – non-cutting, articulated instruments – general requirements & test methods
ISO 7740:2004	Scalpels with detachable blades - Fitting dimensions
ISO 7741:1986	Scissors and shears - General requirements and test methods
ISO 6508-1:2005 (DIN 50103-3:1995)	Specifies the method for Rockwell and Rockwell superficial hardness tests for metallic materials.
BS EN ISO 14971:2012	Medical Devices – Application of risk management to medical devices.
DIN 58298:2010-09	Medical instruments - Materials, finish and testing.
DIN 58299:1964-01	Serrations for surgical instruments; profile angles, groove distances.
DIN 58300:1982-02	Joints for surgical instruments.
HTM 2010	Recommendations for sterilization
AS/NZ 4187-2003	Cleaning, disinfecting & sterilising of re-usable surgical instruments

This information is available on the internet at  
[www.surtex-instruments.co.uk](http://www.surtex-instruments.co.uk)



## INSTRUCTIONS FOR REPROCESSING OF REUSABLE SURGICAL INSTRUMENTS

The following instructions are for all reusable medical devices supplied by Surtex Instruments Ltd, unless stated otherwise with the packaging of the product. These instructions are intended for use only by persons with the required specialist knowledge and training.

### Warnings

- Follow instructions and warnings as issued by the manufacturers of any decontaminants, disinfectants and cleaning agents. Wherever possible avoid use of mineral acids and harsh, abrasive agents.
- No part of the process shall exceed 140 °C.
- Some sensitive materials (e.g. Aluminium) are damaged by high alkaline solutions (pH>10).
- Devices with long, narrow cannula, hinges and blind holes require particular attention during cleaning.

**Note:** When reprocessing medical devices, always handle with care, wearing protective clothing, gloves and eye-wear in accordance with local health & safety procedures.

### Limitations on Reprocessing

- Repeated processing has minimal effect on these instruments.
- End of life normally determined by wear and damage in use.
- Any specific limitations on the number of reprocessing cycles shall be made available with instrument.

### From Point of Use

Whenever possible, do not allow blood, debris or bodily fluids to dry on instruments. For best results and to prolong the life of the medical device reprocess immediately after use. If they cannot be reprocessed immediately, use an enzymatic foam spray cleaner to help prevent soil from drying.

### Preparation for Decontamination

- Process all the instruments as soon as it is reasonably practical following use.
- Disassemble only where intended, without the use of tools unless specifically provided by the manufacturer. Instructions for dis assembly are available with the device, where required.

### Cleaning: Automated

- Use only either CE marked or validated washer-disinfector machines and low foaming, non-ionizing cleaning agents and detergents following the manufacturer's instructions for use, warnings, concentrations and recommended cycles.
- Load instruments carefully, with any box joints and hinges open and so that any fenestration in instruments can drain.
- Place heavy instruments with care in the bottom of containers, taking care not to overload wash baskets.
- Place instruments with concave surfaces facing down to prevent pooling of water.
- Where possible, use appropriate attachments to flush inside reamers and devices with lumens or cannula.
- Ensure that soft, high purity water which is controlled for bacterial endo-toxins is used in the final rinse stage.

**Note:** Automated cleaning may not be suitable for all lumens and cannula in which case clean manually with a water jet gun, if available, and an appropriate brush (and stilette if provided) that reaches the depth of the feature. After manually cleaning, pass all devices through an automatic cleaning cycle to achieve disinfection.

**Note:** These instruments have been validated using a washer-disinfector cycle validated to include two cold rinses at <35 °C, a detergent cycle and a rinse cycle both at >50°C, a disinfection cycle operating at a temperature of between 80 °C and 90 °C for a minimum holding time of 1 minute (actual holding time in excess of 2 minutes 50 seconds) and a 20 minute drying cycle. The detergent used was low foaming, non-ionizing spray wash detergent cleaner (max 12pH) and the rinse aid a neutral pH low foaming, non-ionic surfactant with isopropyl alcohol.

### Cleaning: Manual

- Manual cleaning is not advised if an automatic washer-disinfector is available. If the equipment is not available, use the following process:-
1. Use a double sink system (wash/rinse) dedicated for instrument cleaning (not used for hand washing). Ensure that the water temperature does not exceed 35 of the re-processor to ensure that the reprocessing as actually performed using equipment, materials and personnel in the reprocessing facility achieve the desired result. This requires validation and routine monitoring of the process. Likewise any deviation by the re-processor from the instructions provided must be properly evaluated for effectiveness and potential adverse consequences.
  2. In the first sink, keeping the instrument submerged, with an autoclavable brush, apply CE marked cleaning solution to all surfaces until all soil has been removed. Pay particular attention to serrations, teeth, ratchets and hinges, always brushing away from the body and avoiding splashing. Ensure rongeurs and hinged instruments are thoroughly cleaned in both open and closed positions.
  3. In the second sink, rinse instruments thoroughly with soft, high purity water which is controlled for bacterial endotoxins, so that the water reaches all parts of the instrument, then carefully hand dry or use a drying cabinet.

**Note:** Manual Cleaning is NOT a disinfection process: When manual cleaning is used it may not be possible to disinfect the device prior to further handling.

### Cleaning Inspection

- After cleaning visually inspect, visually inspect all surfaces, cannulations, ratchets, joints, holes and lumens for complete removal of soil and fluids. If ANY soil or fluid is still visible, return the instrument for repeat decontamination.

### Maintenance

- Apply surgical grade lubricant to hinges, joints and moving parts as per the lubricant manufacturer's instructions.

Continued on next page



#### Inspection and Functional Testing

- Visually inspect and check: - all instruments for damage and wear; cutting edges are free from nicks and present a continuous edge; jaws and teeth align correctly; all articulated instruments have a smooth movement without excess play; locking mechanisms (such as ratchets) fasten securely and close easily; long, slender instruments are not distorted; any component parts fit and assemble correctly with mating components.
- Remove for repair and replacement any blunt, worn out, flaking, fractured or damaged instruments.

**Note:** If an instrument is returned to the manufacturer / supplier, the instrument must be decontaminated and sterilized and be accompanied with the relevant documented evidence.

#### Packaging

- All instruments to be packed following local protocol in accordance with ISO 11607-1 or AAMI/CSR technique.

#### Sterilization (USA)

- Autoclave should comply with the requirements of, and be validated and maintained in accordance with ANSI/AAMI ST79.
- Pre-Vacuum moist heat sterilization operating at temperature 132 °C bar for a minimum holding time of 4 minutes always following the instructions of the machine manufacturer.
- When sterilizing multiple instruments in one autoclave cycle, ensure that the sterilizer manufacturers stated maximum load is not exceeded.
- Ensure instruments are dry before sterilization.

#### Sterilization (Outside USA)

- Autoclave should comply with the requirements of, and be validated and maintained in accordance with EN 285, EN 13060, EN ISO 17665.
- Either CE marked or validated vacuum autoclave operating at 134-137 °C bar for a minimum holding time of 3 minutes always following the instructions of the machine manufacturer.
- When sterilizing multiple instruments in one autoclave cycle, ensure that the sterilizer manufacturers stated maximum load is not exceeded.

#### Storage

- Ensure instruments are dry before storage, and stored in dry, clean conditions at an ambient room temperature.

#### Additional Information

- Other forms of cleaning (i.e. ultrasonic) and sterilization (i.e. Low temperature steam and Formaldehyde, Ethylene Oxide and Gas Plasma) are available. However, always follow the instructions for use as issued by the manufacturer and always consult with them if in any doubt over the suitability of any process used.
- Cleaning and sterilizing guidelines are available in HTM 2030 and HTM 2010. Contact: The NHS Estates Stationers Office Publications Cent for details at [www.tsonline.gov.uk](http://www.tsonline.gov.uk). For further information contact: NHS Estates Information Center, Department of Health, 1 Trevelyan Square, Boar Lane, Leeds, LS1 6AE, UK or visit [www.nhsestates.gov.uk](http://www.nhsestates.gov.uk).

**Note:** It is the responsibility of the re-processor to ensure that the reprocessing as actually performed using equipment, materials and personnel in the reprocessing facility achieve the desired result. This requires validation and routine monitoring of the process. Likewise any deviation by the re-processor from the instructions provided must be properly evaluated for effectiveness and potential adverse consequences.





CODE, PAGE & LOGO GUIDE

Company Name & Logo  
Firmenname und Logo  
Nombre y logotipo de la compañía  
Nom et logo de l'entreprise  
Nome e il logo

**Operating Scissors**  
Straight, Sharp/Blunt

Catalog #	Size
SS-004-13 SC	13 cm (5")
SS-004-14 SC	14.5 cm (5 ¾")

**Operating Scissors**  
Curved, Sharp/Blunt

Catalog #	Size
SS-005-11	12 cm (4 ¾")
SS-005-13	13 cm (5")
SS-005-14	14.5 cm (5 ¾")
SS-005-16	16.5 cm (6 ½")
SS-005-18	18.5 cm (7 ¼")
SS-005-20	20.5 cm (8")

**Operating Scissors**  
Curved, Sharp/Blunt

Catalog #	Size
SS-005-13 SC	13 cm (5")
SS-005-14 SC	14.5 cm (5 ¾")

**Operating Scissors**  
Straight, Sharp/Sharp

Catalog #	Size
SS-006-11	12 cm (4 ¾")
SS-006-13	13 cm (5")
SS-006-14	14.5 cm (5 ¾")
SS-006-16	16.5 cm (6 ½")
SS-006-18	18.5 cm (7 ¼")
SS-006-20	20.5 cm (8")

Operating Scissors  
Chirurgische Scheren  
Tijeras quirúrgicas  
Ciseaux chirurgicaux  
Forbici per chirurgia

Product Sub Group  
Produkt-Untergruppe  
Producto Sub Grupo  
Produit Sous-groupe  
Prodotto Sub Gruppo

Product Group  
Produktgruppe  
Grupo de productos  
Groupe de produits  
Gruppo prodotti

Product Picture & Profile  
Produkt Bild und Profil  
Cuadro del producto y Perfil  
Image de produit et de profil  
Immagine del prodotto e il profilo

Web: www.surtex-instruments.co.uk E-mail: sales@surtex-instruments.co.uk

28

Author /  
Product Information  
Autor /  
Produktinformationen  
Autor /  
Información de producto  
Auteur /  
Information produit  
Autore /  
Informazioni sul prodotto

SS-006-11

- SS Product group of discipline
- 006 Consecutive number within the group or discipline
- 11 Size/shaped of the product

- SS Artikelgruppe oder Disziplin
- 006 Laufende Nummer innerhalb der Gruppe oder Disziplin
- 11 Größe/Figur des Instruments

- SS Grupo de artículos o especialidad
- 006 Número corrido dentro del grupo o especialidad
- 11 Tamaño/forma del instrumento

- SS Groupe d'articles ou discipline
- 006 Numéro courant au sein du groupe ou de la discipline
- 11 taille/forme de l'instrument

- SS Gruppo di articoli o, disciplina
- 006 Numero progressivo all'interno del gruppo o della disciplina
- 11 Dimensioni/forma dello strumento



## TECHNICAL TERMS TRANSLATION TABLE

English	German	French	Italian	Spanish
Accessories	Zubehör	Accessoires	Accessori	Accesorios
Adjustable	Verstellbar	Réglable	Adeguabile	Ajustable
Adult size	Erwachsengröße	Taille adulte	Misura Adulto	Tamaño adulto
Angled	Gewinkelt	Coudé	Piegato	Acodado
Arm	Arm	Bras	Braccio	Braso
Articulation	Gelenkverbindung	Articulation	Articolazione	Articulación
Atrauma	Atraumatisch	Atraumatique	Atraumatico	Atraumático
Ball Type	Kugelende	Embout sphérique	Puntale A Palla	Punta con bola
Blade	Blatt, Valve	Valve	Valva	Valva
Blunt	Stumpf	Mousse	Smusso	Romo
Bone	Knochen	Os	Ossa	Hueso
Bone rongeur	Knochenzange	Gouge	Sgorbia	Gubia
Child size	Kindergröße	Taille enfant	Misura Pediatrica	Tamaño niño
Circumflex	Zirkumflex	Circonflexe	Circonflesso	Circunflejo
Counterbalanced	Gegengewichtig	Contre poids	Contropeso	Contra peso
Curved	Gebogen	Courbe	Curvo	Curvo
Delicate	Ampfindlich	Délicat	Delicato	Delicado
Depth	Tiefe	Profondeur	Profondità	Profundidad
Dissecting	Sezierung	Dissection	Dissezione	Dissección
Dissector	Dissektor	Dissecteur	Dissettore	Disector
External	Aussen Liegend	Externe	Esterno	Externo
Fine	Dünn, Fein	Fin	Fino	Fino
Fingerplate	Fingerplatte	Contrôle au doigt	Controllo Digitale	Control digital
Flat	Flach, Eben	Plat	Piatto	Piano
Forceps	Pinzette	Pince	Pinza	Pinza
Hand retractor	Handretraktor	Valve à main	Divaricatore A Mano	Separador a mano
Handle	Griff, Stiel	Manche	Manico	Mango
Height	Höhe	Hauteur	Altezza	Altura
Hook	Haken	Crochet	Gancio	Gancho
Infant	Kleinkind	Nourisson	Bambino	Niño de pecho
Jaws	Kinnbacken	Mors	Morso	Boca
Knot pusher	Schlingengabel	Pousse noeud	Stringinodo	Empujador de nudo
Large	Gross	Grand	Grande	Alto
Left	Links	Gauche	Sinistro	A la izquierda
Length	Länge	Longueur	Lunghezza	Longitud
Ligature	Unterbindung	Ligature	Ligatura	Ligatura
Lung	Lunge	Poumon	Polmone	Pulmón
Medium	Mittel	Moyen	Medio	Medio
Multipurpose	Mehrzweck	Multi-fonctions	Funzione Multipla	Multi-función
Needle holder	Nadelhalter	Porte aiguille	Portaghi	Porta agujas
Needle pulling	Nadelaufnehmer	À saisir les aiguilles	Pinza Stringi Ago	Para coger las agujas
Newborn	Neugeborenen	Nouveau né	Neonato	Recién nacido
On Flat	Flach	Sur le plat	Piatto En	En el plano
Opening	Öffnung	Ouverture	Apertura	Apertura
Pair	Paar	Paire	Paia	Pár
Prong	Zinke	Griffe	Denti	Dientes
Rack	Gestell	Crémaillère	Cremagliera	Cremallera
Raspatory	Schabeisen	Rugine	Raschiatoio	Raspador
Ratchet	Sperre	Crémaillère	Cremagliera	Cremallera
Retractor	Retraktor	Ecarteur	Divaricatore	Separador
Rib contractor	Rippenschliesser	Rapprocheur de côtes	Appaltatore DI Costole	Aproximador costal
Right	Rechts	Droite	Destra	A la derecha
Ring Handle	Ringgriff	A anneaux	Ad Anelli	Con anillos
Ring Tip	Ringspitze	Embout en anneau	Punta Ad Anelli	Punta con anillo
Rongeur	Knochenzange	Gouge	Sgorbia	Gubia
Round	Rund	Rond	Ton Do	Redondo
Scissors	Schere	Ciseaux	Forbici	Tijeras
Serrated	Gezähnt	Strié	Striato	Estriado
Shanks	Schenkel	Branches	Ramo	Mango
Sharp	Scharf	Acéré	Acute	Acerado
Small	Klein	Petit	Piccolo	Pequeño
Smooth	glatt	Lisse	Liscio	Liso
Spatula	Spatel	Spatule	Spatula	Espátula
Straight	Gerade	Droit	Dritto	Recto
Suction tube	Saugrohr	Canule d'aspiration	Canula DI Aspiraione	Cánula de aspiración
Suture passer	Suture passer	Tire-Fil	Passa-fili	Pasa-hilo
Teeth	Zähne	Dents	Denti	Dientes
Thermic purge	Thermische	Purgeur	Purgatore	Purgador
Thin	Dünn	Etroit	Ristretto	Estrecho
Thread	Faden, Zwirn	Torsade	Filo	Hilo
Tip	Spitze	Bout	Estremità	Punta
Tissue seizing	Gewebegrasse	Préhension	Presca	Presión
Twister	Dreher	Pince à torsader	Cerchiatura	Pinza para retorcer
Tying forceps	Binden	Dissection	Dissezione	Dissección
Vessel	Gefä	Vaisselleau	Vaso	Vaso
Width	Breite / Weite	Largeur	Larghezza	Anchura
Wire Cutter	Drahtschneider	Coupe-Fils	Taglia Cavo	Alicata para cortar alambre
With / Without	Mit / Ohne	Avec / Sans	Con / Senza	Con / Sin



MEASUREMENTS, STANDARDS, AND CONVERSIONS

Millimeter Equivalents

MM = INCHES	MM = INCHES	MM = INCHES
.1 = .00384	29.0 = 1.14173	65.0 = 2.55905
.2 = .00787	30.0 = 1.18110	66.0 = 2.59842
.3 = .01181	31.0 = 1.22047	67.0 = 2.63779
.4 = .01575	32.0 = 1.25984	68.0 = 2.67716
.5 = .01968	33.0 = 1.29921	69.0 = 2.71653
.6 = .02362	34.0 = 1.33858	70.0 = 2.75590
.7 = .02756	35.0 = 1.37795	71.0 = 2.79527
.8 = .03149	36.0 = 1.41732	72.0 = 2.83464
.9 = .03543	37.0 = 1.45669	73.0 = 2.87401
1.0 = .03937	38.0 = 1.49606	74.0 = 2.91338
2.0 = .07874	38.1 = 1.5 in	75.0 = 2.95275
3.0 = .11811	39.0 = 1.53543	76.0 = 2.99212
4.0 = .15748	40.0 = 1.57480	76.2 = 3.0 in
5.0 = .19685	41.0 = 1.61417	77.0 = 3.03149
6.0 = .23622	42.0 = 1.65354	78.0 = 3.07056
7.0 = .27559	43.0 = 1.69291	79.0 = 3.11023
8.0 = .31496	44.0 = 1.73228	80.0 = 3.14960
9.0 = .35433	45.0 = 1.77165	81.0 = 3.18897
10.0 = .39370	46.0 = 1.81102	82.0 = 3.22834
11.0 = .43307	47.0 = 1.85039	83.0 = 3.26771
12.0 = .47244	48.0 = 1.88976	84.0 = 3.30708
12.7 = .5 in	49.0 = 1.92913	85.0 = 3.34645
13.0 = .51181	50.0 = 1.96350	86.0 = 3.38582
14.0 = .55118	50.8 = 2.0 in	87.0 = 3.42519
15.0 = .59055	51.0 = 2.00787	88.0 = 3.46456
16.0 = .62992	52.0 = 2.04724	88.9 = 3.5 in
17.0 = .66929	53.0 = 2.08661	89.0 = 3.50393
18.0 = .70866	54.0 = 2.12598	90.0 = 3.54330
19.0 = .74803	55.0 = 2.16535	91.0 = 3.58267
20.0 = .78740	56.0 = 2.20472	92.0 = 3.62204
21.0 = .82677	57.0 = 2.24409	93.0 = 3.66141
22.0 = .86614	58.0 = 2.28346	94.0 = 3.70078
23.0 = .90551	59.0 = 2.32283	95.0 = 3.74015
24.0 = .94488	60.0 = 2.36220	96.0 = 3.77952
25.0 = .98425	61.0 = 2.40157	97.0 = 3.81889
25.4 = 1.0 in	62.0 = 2.44094	98.0 = 3.85826
26.0 = 1.02362	63.0 = 2.48031	99.0 = 3.89763
27.0 = 1.06299	63.5 = 2.5 in	100.0 = 3.93700
28.0 = 1.10236	64.0 = 2.51968	101.6 = 4.0 in

Needle Tubing Equivalents

SIZE GAUGE NO.	APPROX. O.D.	
	MM	INCHES
26	0.4	.018
24	0.5	.022
22	0.7	.028
20	0.9	.035
18	1.3	.053
16	1.6	.065
14	2.1	.083
12	2.8	.109
10	3.4	.134
8	4.2	.165
6	5.1	.203

Suction Tubing Equivalents

SIZE FRENCH GAUGE NO.	APPROX. O.D.	
	MM	INCHES
3	1.0	.039
4	1.3	.053
5	1.7	.066
6	2.0	.079
7	2.3	.092
8	2.7	.105
9	3.0	.118
10	3.3	.131
11	3.7	.144
12	4.0	.158
13	4.3	.170
14	4.7	.184
15	5.0	.197
16	5.3	.210



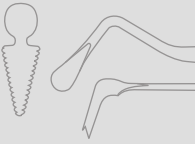
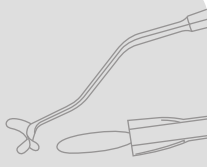
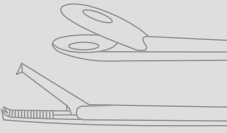
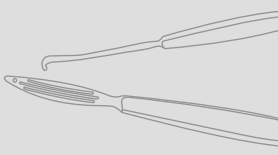
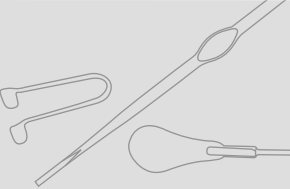

## TABLE OF CONTENTS

<p><b>OM</b></p> <p>Oral Maxillo-facial Surgery Mund-, Kiefer- Und Gesichtschirurgie Cirugía Oral Y Maxilofacial Chirurgie Buccale Et Maxillo-faciale Chirurgia Maxillo-facciale</p> 	<p><b>TL</b></p> <p>Tonsillectomy, Laryngo-bronchoscopy Tonsillektomie, Laryngo-bronchoskopie Tonsilectomia, Laringo-bronchoscopia Tonsillectomie, Laryngo-bronchoscopie Tonsilectomia, Laringo-bronchoscopia</p> 
<p><b>OT</b></p> <p>Otology Instruments Otologie Otologia Otologie Otologia</p> 	<p><b>TM</b></p> <p>Tracheotomy Instruments Tracheotomie Traqueotomia Trachéotomie Tracheotomia</p> 
<p><b>RH</b></p> <p>Rhinology Instruments Rhinologie Rinología Rhinologie Rinologia</p> 	





**SURTEX**  
INSTRUMENTS

*Crafted to Excellence*

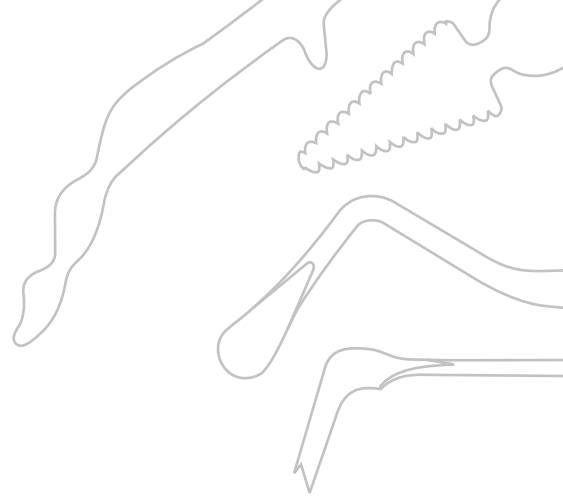

OM

## ORAL MAXILLO-FACIAL SURGERY

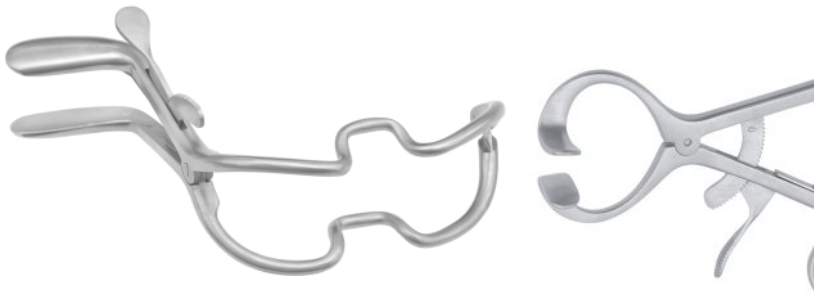

Oral and maxillofacial surgery deals with a variety of conditions associated with the mouth, jaws, face and neck. Severe traumas and deformities do not only pose a risk to the function of the senses, but they often also entail psychosocial consequences.

This speciality encompasses the management of developmental facial anomalies including cleft lip and palate, facial trauma and surgery required in the management of orofacial malignancy. The scope of oral and maxillofacial surgery has widened over the last 15 years and continues to develop. An extensive array of procedures are performed, ranging from relatively minor surgery through to complex major head and neck surgery. There is a strong emphasis on reconstruction and operating in this emotionally and cosmetically sensitive area provides considerable clinical challenges.

Surtext presents a broad range of instruments for oral & maxillofacial surgery that help surgeons overcome clinical challenges in this speciality. Our range includes but is not limited to the mouth gags, oral and maxillofacial retractors, elevators, osteotomes, awls, bone separators, repositioning instruments and disimpaction instruments etc.

Mund-, Kiefer- und Gesichtschirurgie

Cirugía oral y maxilofacial

Chirurgie buccale et maxillo-faciale

Chirurgia maxillo-facciale



Finger Protectors, Mouth Gag  
Finger-Protektoren, Mund-Gags  
Protectores de dedo, Mordaza De la Boca  
Protections de doigt, Bâillon De Bouche  
Protezioni Finger, Bocca Bavaglio

**Adams Napkin Holder**

Consisting of Chain and Two Crocodile Forceps



Catalog #	Size
OM-011-01	Standard

**Langenbeck Finger Protector**

Catalog #	Diameter
OM-015-01	Ø 18.0 mm
OM-015-02	Ø 21.0 mm
OM-015-03	Ø 22.0 mm



**Maunder Mouth Gag**  
Wood

Catalog #	Size
OM-018-10	Standard



**Heister Mouth Gag**

Catalog #	Size
OM-030-13	13 cm (5")



**Obwegeser Mouth Gag**

Catalog #	Size
OM-032-11	11 cm (4 1/4")



INCHES  
MILLIMETERS





Mouth Gag  
Mund-Gags  
Mordaza De la Boca  
Bâillon De Bouche  
Bocca Bavaglio

**Molt Mouth Gag**

Catalog #	Size
OM-035-11	11 cm (4 1/4")
OM-035-14	13 cm (5")



**Denhart Mouth Gag**

Catalog #	Size, Jaw Size
OM-039-12	13 cm (5"), 16 mm



**Roser-Koenig Mouth Gag**

Catalog #	Size
OM-041-16	16 cm (6 1/4")
OM-041-20	20 cm (8")

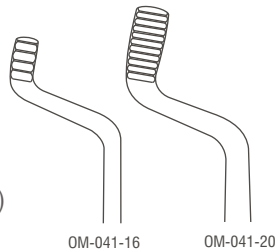

**Fergusson-Ackland Mouth Gag**

Catalog #	Size
OM-043-18	14.5 cm (5 3/4")
OM-043-20	18 cm (7")



**Jennings Mouth Gag**

Catalog #	Size
OM-047-09	10.5 cm (4")
OM-047-11	12.5 cm (5")
OM-047-13	14.5 cm (5 3/4")
OM-047-15	16.5 cm (6 1/2")





Mouth Gag  
Mund-Gags  
Mordaza De la Boca  
Bâillon De Bouche  
Bocca Bavaglio

**Whitehead Mouth Gag**  
Without Tongue Depressor Ratchet

Catalog #	Size
OM-049-11	11 cm (4 1/4")
OM-049-13	13 cm (5")
OM-049-15	15 cm (6")

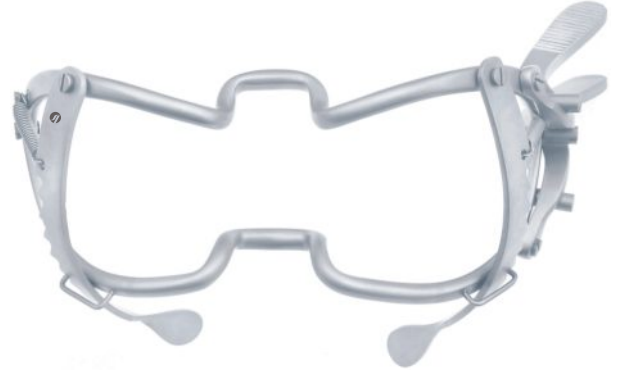

**Whitehead Mouth Gag**  
With Tongue Depressor Ratchet

Catalog #	Size
OM-051-13	13 cm (5")



**Negus Chest Support for Mouth Gag**

Catalog #	Size
OM-058-00	20 cm (8")



**Kilner-Doughty Mouth Gag Complete**  
With 3 Tongue Depressors

Catalog #	Size
OM-060-00	Standard



**Kilner-Doughty Mouth Gag**  
Frame Only

Catalog #	Size
OM-061-00	14.5 cm (5 3/4")





Mouth Gag  
Mund-Gags  
Mordaza De la Boca  
Bâillon De Bouche  
Bocca Bavaglio

**Kilner-Doughty Tongue Depressor**  
Fenestrated Blade for Suction

Catalog #	Size, Blade Size
OM-063-01	13.5 cm (5 1/4"), 70 x 29 mm
OM-063-02	13.5 cm (5 1/4"), 80 x 34 mm
OM-063-03	13.5 cm (5 1/4"), 85 x 38 mm



**Davis-Boyle Mouth Gag Complete**  
With 5 Tongue Depressors Ref:- OM-073-01 to OM-073-05

Catalog #	Size
OM-070-00	Standard



**Davis-Boyle Mouth Gag**  
Frame Only

Catalog #	Size
OM-071-00	Adult
OM-071-01	Child



**Davis-Boyle Tongue Depressor**  
With Fixed Suction Tube

Catalog #	Size, Blade Size
OM-073-01	13.5 cm (5 1/4"), 110 x 26 mm
OM-073-02	13.5 cm (5 1/4"), 95 x 25 mm
OM-073-03	13.5 cm (5 1/4"), 80 x 24 mm
OM-073-04	13.5 cm (5 1/4"), 65 x 23 mm
OM-073-05	13.5 cm (5 1/4"), 30 x 20 mm

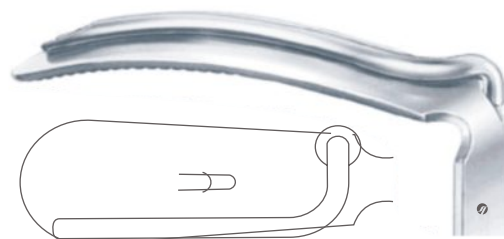

**Davis-Boyle Tongue Depressor**  
With Suction Tube

Catalog #	Size, Blade Size
OM-073-05	13.5 cm (5 1/4"), 30 x 20 mm





Mouth Gag  
Mund-Gags  
Mordaza De la Boca  
Bâillon De Bouche  
Bocca Bavaglio

**Mclvor Mouth Gag Complete**

With 3 Tongue Depressors Ref:- OM-083-01 to OM-083-03

Catalog #	Size
OM-080-00	Standard



**Mclvor Mouth Gag  
Frame Only**

Catalog #	Size
OM-081-00	15 cm (6")



**Mclvor Tongue Depressor**

Catalog #	Size, Blade Size
OM-083-01	13.5 cm (5 1/4"), 100 x 26 mm
OM-083-02	13.5 cm (5 1/4"), 85 x 25 mm
OM-083-03	13.5 cm (5 1/4"), 75 x 23 mm



**Dingmann Mouth Gag Complete**

With 3 Tongue Depressors Ref:- OM-093-01 to OM-093-03

Catalog #	Size
OM-090-00	Standard



**Dingmann Mouth Gag**

Catalog #	Size
OM-091-00	14.5 cm (5 3/4")





Mouth Gag  
Mund-Gags  
Mordaza De la Boca  
Bâillon De Bouche  
Bocca Bavaglio

**Dingmann Tongue Depressor**

Catalog #	Size, Blade Size
OM-093-01	13.5 cm (5 1/4"), 65 x 25 mm
OM-093-02	13.5 cm (5 1/4"), 70 x 29 mm
OM-093-03	13.5 cm (5 1/4"), 80 x 32 mm



**Negus Tongue Depressor**

Catalog #	Size, Blade Size
OM-097-01	13.5 cm (5 1/4"), 70 x 20 mm
OM-097-02	13.5 cm (5 1/4"), 80 x 30 mm
OM-097-03	13.5 cm (5 1/4"), 95 x 35 mm



**Russel-Davis Tongue Depressor**

Catalog #	Size, Blade Size
OM-099-01	13.5 cm (5 1/4"), 18 x 55 mm
OM-099-02	13.5 cm (5 1/4"), 22 x 65 mm
OM-099-03	13.5 cm (5 1/4"), 25 x 75 mm
OM-099-04	13.5 cm (5 1/4"), 28 x 65 mm
OM-099-05	13.5 cm (5 1/4"), 32 x 75 mm
OM-099-06	13.5 cm (5 1/4"), 37 x 80 mm
OM-099-07	13.5 cm (5 1/4"), 40 x 90 mm
OM-099-08	13.5 cm (5 1/4"), 45 x 100 mm



**Draffin Bipod Complete**

Catalog #	Size, Detail
OM-100-00	Standard, With 2 Draffin Bipod Rod Ref:- OM-100-48
OM-100-01	40 cm (15 3/4"), <b>Maguaran</b> , Plate For Holding Draffin Bipod
OM-100-48	48 cm (19"), <b>Draffin Bipod Rod</b> , With 4 Rings for Varying Height

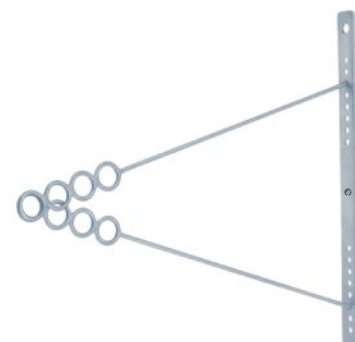



Lip and Cheek Retractors  
 Lippen-und Wangenhalter  
 Labios y Mejillas Retractores  
 Lèvres et jugaux  
 Labbra e guance Divaricatori

**McKesson Mouth Prop**

Catalog #	Profile
OM-110-01	Small
OM-110-02	Medium
OM-110-03	Large

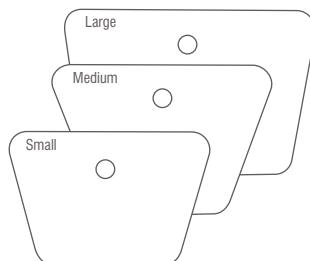

**Martin-Simplex Lip and Cheek Retractor**

Catalog #	Size
OM-121-11	10 cm (4")



**Obwegeser Lip and Cheek Retractor**

Catalog #	Size
OM-123-12	10 cm (4 3/4")

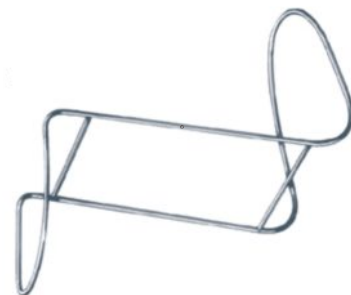

**Bishop Lip and Cheek Retractor**

Catalog #	Size, Blade Width
OM-127-13	13.5 cm (5 1/4"), 27 mm



**Cawood-Minnesota Cheek Retractor**

Catalog #	Size, Blade Width
OM-131-15	15 cm (6"), 20 mm

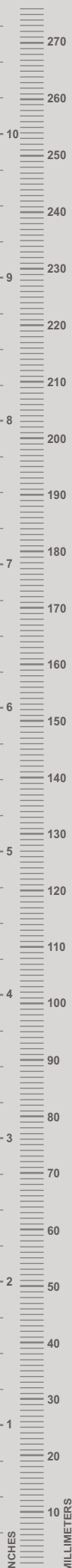



Tongue Depressors  
Zungesenker  
Bajalenguas  
Abaisse-langue  
Abbassalingua

**Minnesota Cheek Retractor**



Catalog #	Size
OM-135-14	14.5 cm (5 3/4")

**Hartmann Tongue Depressor**



Catalog #	Size, Blade Size
OM-141-15	15 cm (6"), 72 x 23 mm

**Tobold Tongue Depressor**

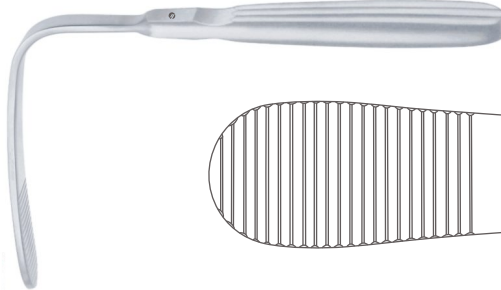

Catalog #	Size, Blade Size
OM-143-15	15 cm (6"), 88 x 25 mm

**Andrew Tongue Depressor**

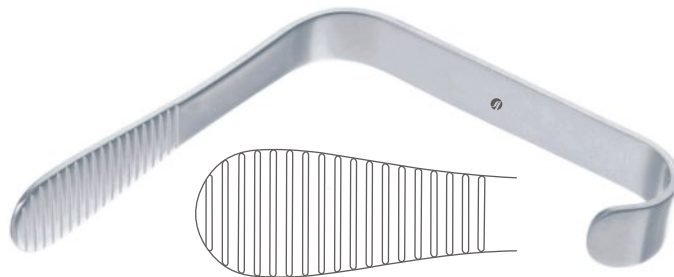

Catalog #	Size
OM-145-14	14.5 cm (5 3/4")

**Wieder Tongue Depressor**

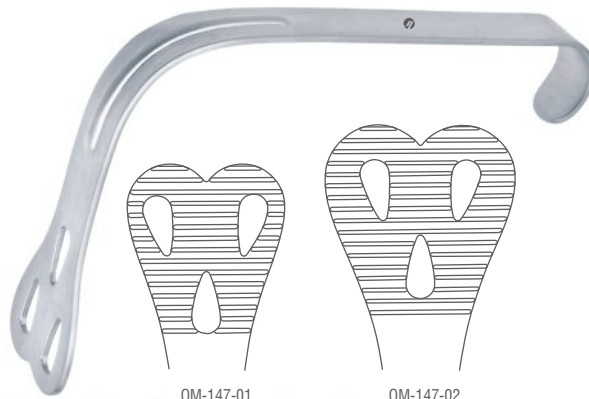

Catalog #	Size, Blade Width
OM-147-01	14 cm (5 1/2"), 36 mm
OM-147-02	15 cm (6"), 43 mm

OM-147-01

OM-147-02



Tongue Depressors, Tongue Holding Forceps  
Zungesenker, Zungehaltezangen  
Bajalenguas, Pinza tira-lengua  
Abaisse-langue, Pincès tire-langue  
Abbassalingua, Pinze per lingua

### Standard Tongue Depressor

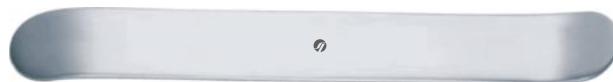

Catalog #	Size
OM-151-14	14.5 cm (5 3/4")

### Koenig Tongue Depressor



Catalog #	Size
OM-153-15	15 cm (6")

### Mayo Tongue Depressor



Catalog #	Size
OM-155-17	17 cm (6 3/4")

### Bruenings Tongue Depressor



Catalog #	Size, Blade Width 1 - Blade Width 2
OM-159-19	19 cm (7 1/2"), 19 mm - 15 mm

### Collin Tongue Holding Forcep



Catalog #	Size, Jaw Size
OM-170-17	17 cm (6 3/4"), 24 x 27 mm





Tongue Holding Forceps  
Zungehaltezaugen  
Pinza tira-lengua  
Pincés tire-langue  
Pinze per lingua

**Young Tongue Holding Forcep**



Catalog #	Size
OM-173-17	15 cm (6")

**Henahan Retractor**

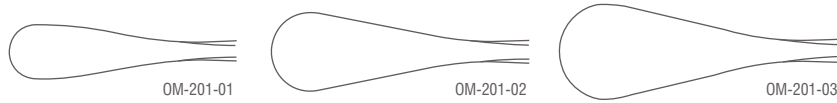

Catalog #	Size, Profile
OM-201-01	18 cm (7"), Fig. 1
OM-201-02	18 cm (7"), Fig. 2
OM-201-03	18 cm (7"), Fig. 3



**Sigmoid Notch Extra Oral Retractor**  
Concave Blade Full Bent Tip

Catalog #	Size, Blade Size
OM-251-24	22 cm (8 3/4"), 9.5 mm x 16 mm



**Petri Intra Oral Retractor**  
For LeFort Osteotomies

Catalog #	Size, Blade Width
OM-255-24	23 cm (9"), 25.5 mm



**Bauer Intra Oral Retractor**  
Left

Catalog #	Size
OM-259-21	21 cm (8 1/4")





Oral Retractors  
Orale Wundhaken  
Separadores orales  
Rétracteurs orales  
Divaricatori orali

**Bauer Intra Oral Retractor**  
Right



Catalog #	Size
OM-261-21	21 cm (8 1/4")

**Levasseur-Merrill Intra Oral Retractor**



Catalog #	Size
OM-265-25	25 cm (9 3/4")

**Obwegeser Soft Tissue Retractor**  
Bent Upwards



Catalog #	Size, Blade Size
OM-271-16	24 cm (9 1/2"), 5 x 16 mm
OM-271-25	24 cm (9 1/2"), 7 x 25 mm
OM-271-35	24 cm (9 1/2"), 10 x 35 mm
OM-271-42	24 cm (9 1/2"), 10 x 42 mm
OM-271-55	24 cm (9 1/2"), 12 x 55 mm
OM-271-70	24 cm (9 1/2"), 14 x 70 mm
OM-271-80	24 cm (9 1/2"), 16 x 80 mm

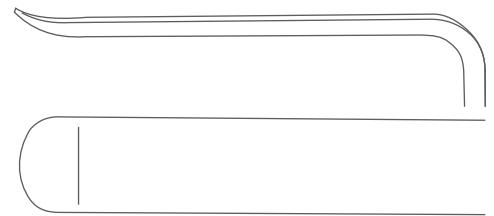

**Obwegeser Soft Tissue Retractor**  
Bent Downwards



Catalog #	Size, Blade Size
OM-273-16	24 cm (9 1/2"), 5 x 16 mm
OM-273-25	24 cm (9 1/2"), 7 x 25 mm
OM-273-35	24 cm (9 1/2"), 10 x 35 mm
OM-273-42	24 cm (9 1/2"), 10 x 42 mm
OM-273-55	24 cm (9 1/2"), 12 x 55 mm
OM-273-70	24 cm (9 1/2"), 14 x 70 mm
OM-273-80	24 cm (9 1/2"), 16 x 80 mm

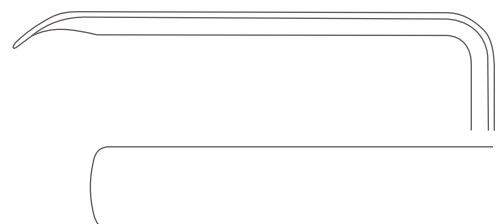



Soft Tissue Retractors  
Weichteilhaken  
Separadores de tejidos blandos  
Rétracteurs des tissus mous  
Divaricatori tessuti molli

**Obwegeser Soft Tissue Retractor**

Bent Upwards

Catalog #	Size, Blade Size
OM-275-43	21.5 cm (8 1/2"), 11 x 43 mm
OM-275-57	21.5 cm (8 1/2"), 11 x 57 mm
OM-275-83	21.5 cm (8 1/2"), 16 x 83 mm

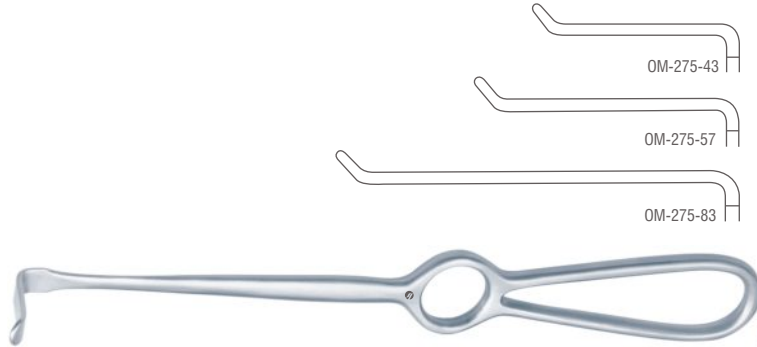

**Obwegeser Mandibular Retractor**

Catalog #	Size, Blade Size
OM-279-30	21 cm (8 1/4"), 12 x 30 mm
OM-279-45	21 cm (8 1/4"), 12 x 45 mm
OM-279-60	21 cm (8 1/4"), 12 x 60 mm

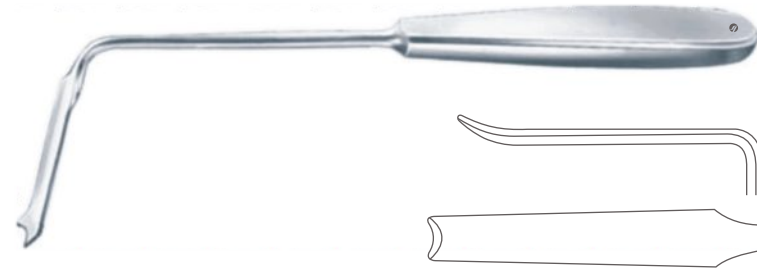

**Obwegeser Ramus Retractor**

Catalog #	Size, Blade Size
OM-281-22	24.5 cm (9 3/4"), 15 x 70 mm



**Obwegeser Ramus Retractor**

Catalog #	Size, Blade Size
OM-283-22	24.5 cm (9 3/4"), 22 x 70 mm



**Obwegeser Ramus Retractor (Nasal Spine Retractor)**

Catalog #	Size, Blade Size
OM-287-22	22 cm (8 3/4"), 45 x 10 mm





Oral Retractors  
Orale Wundhaken  
Separadores orales  
Rétracteurs orales  
Divaricatori orali

**Obwegeser Ramus Retractor**

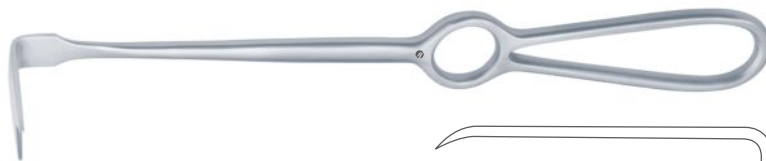

Catalog #	Size, Blade Size
OM-289-22	22 cm (8 3/4"), 72 x 10 mm

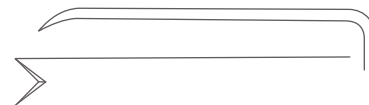

**Steinhauser Zygomatic Retractor**



Catalog #	Size, Profile
OM-291-01	24 cm (9 1/2"), Right
OM-291-02	24 cm (9 1/2"), Left

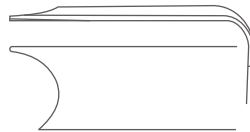

OM-291-01

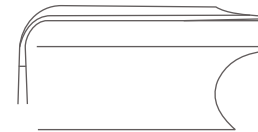

OM-291-02

**Obwegeser Chin Retractor**



Catalog #	Size
OM-301-16	16.5 cm (6 1/2")

**Obwegeser Channel Retractor**



Catalog #	Size, Blade Width
OM-305-08	17 cm (6 3/4"), 8 mm
OM-305-10	17 cm (6 3/4"), 10 mm

**Hargis Medial Ramus Retractor**

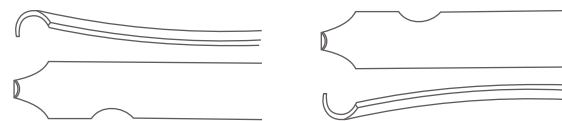

OM-315-01

OM-315-02



Catalog #	Size, Profile
OM-315-01	19.5 cm (7 3/4"), Right
OM-315-02	19.5 cm (7 3/4"), Left



Oral Retractors, Periosteal Elevator  
Orale Wundhaken, Raspatorium  
Separadores orales, Elevador perióstico  
Rétracteurs orales, Ascenseur périostée  
Divaricatori orali, Scollaperiostio

**Hargis Mandibular Body Retractor**

Catalog #	Size
OM-319-18	18 cm (7")

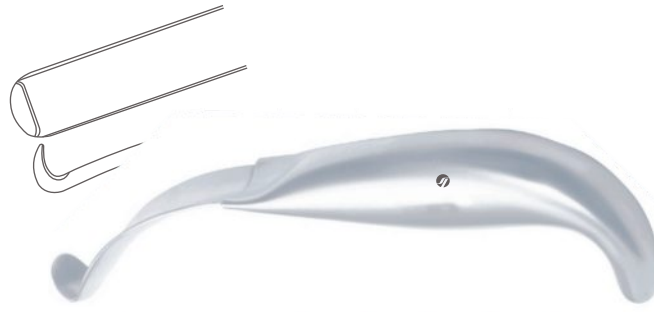

**Hargis Anterior Border Stripper**

Catalog #	Size
OM-331-19	19 cm (7 1/2")



**Hargis Periosteal Elevator  
Right**

Catalog #	Size, Width
OM-333-06	23 cm (9"), 6.5 mm
OM-333-09	23 cm (9"), 9.0 mm

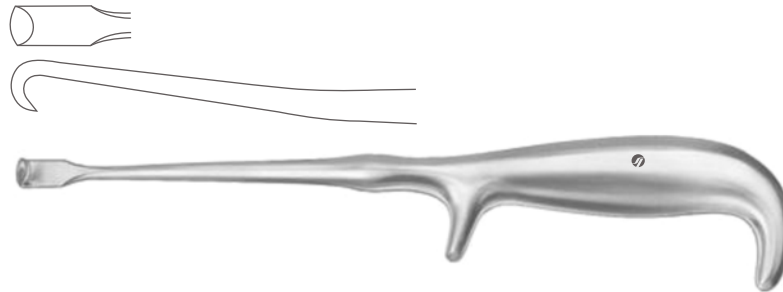

**Hargis Periosteal Elevator  
Left**

Catalog #	Size, Width
OM-335-06	23 cm (9"), 6.5 mm
OM-335-09	23 cm (9"), 9.0 mm

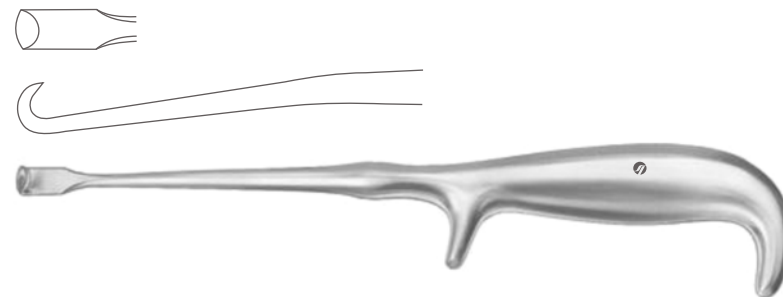

**Hargis Periform Rim Retractor**

Catalog #	Size, Width
OM-337-18	18.5 cm (7 1/4")





Periosteal Elevator  
Raspatorium  
Elevador perióstico  
Ascenseur périostée  
Scollaperiostio

**Hargis Pterygoid Osteotome**



Catalog #	Size, Width
OM-339-22	22 cm (8 3/4")

**Hargis Bone Holding Forcep  
With Chain**

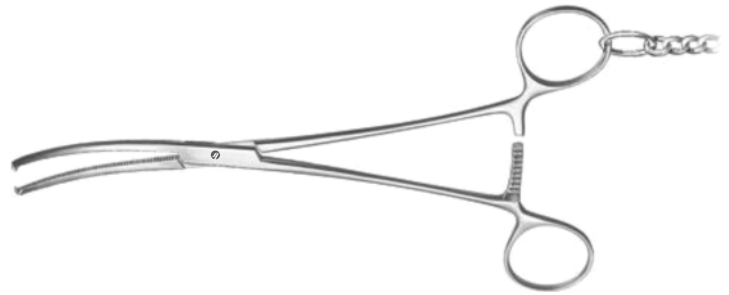

Catalog #	Size, Width
OM-341-19	19 cm (8")

**Obwegeser Periosteal Elevator**

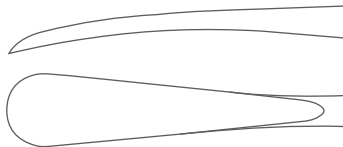

Catalog #	Size, Blade Width
OM-361-04	17.5 cm (7"), 4 mm
OM-361-06	17.5 cm (7"), 6 mm
OM-361-07	17.5 cm (7"), 7 mm
OM-361-09	17.5 cm (7"), 9 mm
OM-361-11	17.5 cm (7"), 11 mm



**Obwegeser Elevator  
Fig. 1**



Catalog #	Size
OM-381-21	20.5 cm (8")



**Obwegeser Elevator  
Fig. 2**

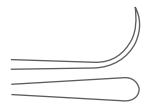

Catalog #	Size
OM-383-21	20.5 cm (8")





Periosteal Elevator  
Raspatorium  
Elevador perióstico  
Ascenseur périostée  
Scollaperiostio

**Obwegeser J-Stripper**

Catalog #	Size, Blade Width
OM-401-05	20.5 cm (8"), 5 mm
OM-401-07	20.5 cm (8"), 7 mm
OM-401-09	20.5 cm (8"), 9 mm

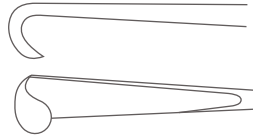

**Obwegeser Ramus Stripper**

Catalog #	Size, Profile
OM-405-01	17.5 cm (7"), Fig. 1
OM-405-02	17.5 cm (7"), Fig. 2

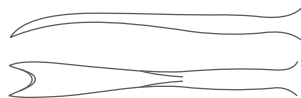

OM-405-01

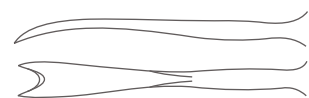

OM-405-02



**Terry Ramus Pusher**

Catalog #	Size
OM-415-24	24 cm (9 1/2")

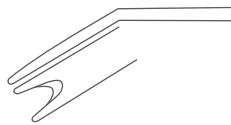

**Steinhauser Reposition Instrument**

Catalog #	Size
OM-421-18	18 cm (7")

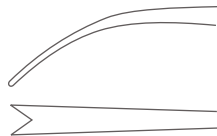

**Tatum Sinus Lift Curette**  
Fig. 1

Catalog #	Size, Blade Width
OM-451-01	18 cm (7"), 2.6 mm - 2.6 mm





Sinus Lift Curettes  
Sinus Lift Küretten  
Curetas Sinus Lift  
Curettes Sinus Lift  
Curette rialzo del seno

**Tatum Sinus Lift Curette**  
Fig. 2



Catalog #	Size, Blade Width
OM-453-02	17.5 cm (7"), 2.6 mm - 2.6 mm

**Tatum Sinus Lift Curette**  
Fig. 3



Catalog #	Size, Blade Width
OM-455-03	18 cm (7"), 4.1 mm - 4.1 mm

**Tatum Sinus Lift Curette**  
Fig. 4



Catalog #	Size, Blade Width
OM-457-04	18.5 cm (7 1/4"), 4.1 mm - 4.1 mm

**Tatum Sinus Lift Curette**  
Fig. 5



Catalog #	Size, Blade Width
OM-459-05	18.5 cm (7 1/4"), 6.7 mm - 6.7 mm

**Tatum Sinus Lift Curette**  
Fig. 6



Catalog #	Size, Blade Width
OM-461-06	19 cm (7 1/2"), 6.7 mm - 6.7 mm





Sinus Lift Curettes, Maxillary Awls  
Sinus Lift Küretten, Unterkieferahlen  
Curetas Sinus Lift, Leznas Maxilares  
Curettes Sinus Lift, Alênes maxillaires  
Curette rialzo del seno, Punteruoli mascellari

**Tatum Sinus Lift Curette**  
Fig. 7



Catalog #      Size, Blade Width  
OM-463-07      16 cm (6 1/4"), 2.8 mm - 6.2 mm

**Tatum Sinus Lift Curette**  
Fig. 8



Catalog #      Size, Blade Width  
OM-465-08      16 cm (6 1/4"), 2.8 mm - 6.2 mm

**Tatum Sinus Lift Curette**  
Fig. 9



Catalog #      Size, Blade Width  
OM-467-09      15 cm (6"), 3.1 mm - 3.1 mm

**Tatum Sinus Lift Curette**  
Fig. 10



Catalog #      Size, Blade Width  
OM-469-10      17 cm (6 3/4"), 5.6 mm - 5.6 mm

**Obwegeser Maxillary Awl**



OM-501-15

OM-501-17



Catalog #      Size  
OM-501-15      15 cm (6")  
OM-501-17      17.5 cm (7")



Sinus Lift Curettes, Sagittal Split Separators, Ramus Separator  
Sinus Lift Küretten, Sagittalspreizer, Spreizzange  
Curetas Sinus Lift, Separadores sagitales, Pinza para separar la rama  
Curettes Sinus Lift, Ecarteurs sagitaux, Pince pour séparer ramus  
Curette rialzo del seno, Separatori sagittali, Pinza per separare il ramo

**Obwegeser Zygomatic Arch Awl**



Catalog #	Size
OM-503-24	24 cm (9 1/2")

**Obwegeser Maxillary Awl**



Catalog #	Size
OM-507-18	18 cm (7")

**Obwegeser Wire Loop Forcep**



Catalog #	Size
OM-540-15	15 cm (6")

**Smith Ramus Separator**

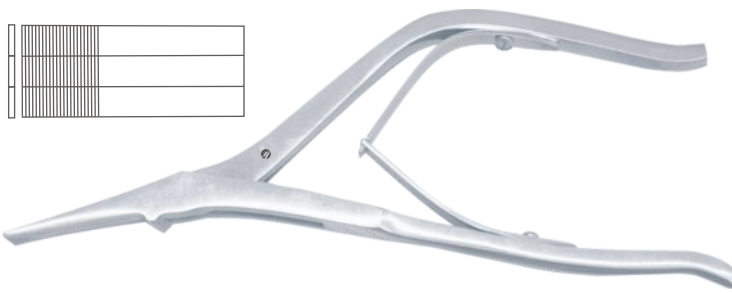

Catalog #	Size
OM-550-20	23.5 cm (9 1/4")

**Smith Sagittal Split Separator**

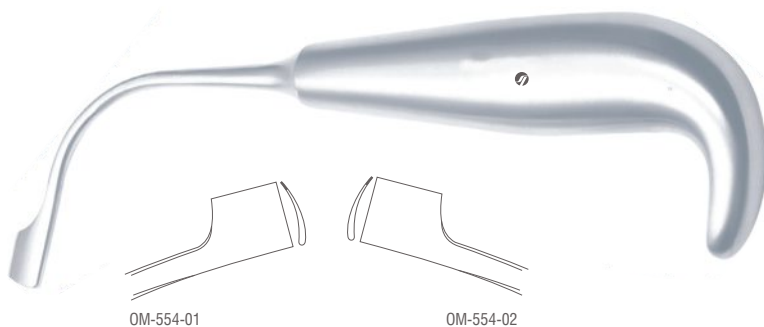

Catalog #	Size, Profile
OM-554-01	18.5 cm (7 1/4"), Right
OM-554-02	18.5 cm (7 1/4"), Left

OM-554-01

OM-554-02



Disimpaction Forcep, Zygoma Elevators  
Repositionszangen, Zygoma-Elevatorien  
Pinzas para reposición, Elevadores, cigomáticos  
Pinces de reposition, Elévateurs zygommatiques  
pinze per riduzione, Elevatori per zigomo

**Rowe Disimpaction Forcep**

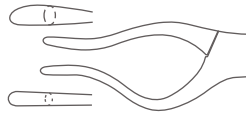

Catalog #      Size, Profile  
OM-570-01      22.5 cm (8 ¾"), Left

**Rowe Disimpaction Forcep**

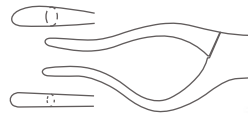

Catalog #      Size, Profile  
OM-570-02      22.5 cm (8 ¾"), Right

**Gillies Zygoma Elevator**

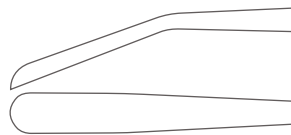

Catalog #      Size  
OM-601-21      20 cm (8")

**Dingmann Zygoma Elevator**



Catalog #      Size, Tip Diameter  
OM-602-21      21 cm (8 ¼"), Ø 5.0 mm

**Rowe Zygoma Elevator**



Catalog #      Size  
OM-605-21      21.5 cm (8 ½")



Osteotomes  
Osteotome  
Osteótomos  
Ostéotomes  
Osteotomi

**Boise Nasal Fracture Elevator**



Catalog #	Size, Tip Size
OM-607-19	19.5 cm (7 3/4")

**Dingman Bone Hook**

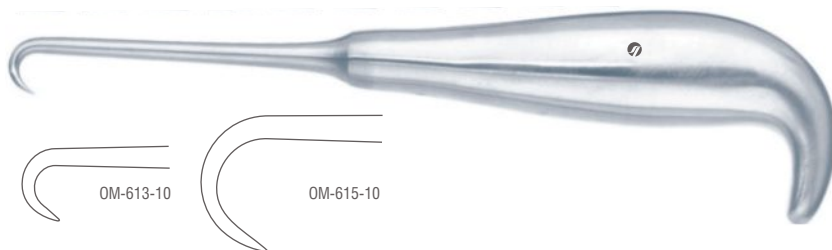

Catalog #	Size, Tip Size
OM-613-10	20 cm (8"), 10 mm
OM-615-10	20 cm (8"), 20 mm

**Bauer Osteotome**  
Straight



Catalog #	Size, Width
OM-620-06	20.5 cm (8"), 6 mm
OM-620-08	20.5 cm (8"), 8 mm

**Bauer Osteotome**  
Curved



Catalog #	Size, Width
OM-621-06	20.5 cm (8"), 6 mm
OM-621-08	20.5 cm (8"), 8 mm

**Epker-Bauer Osteotome**  
Curved



Catalog #	Size, Width
OM-623-08	17.5 cm (7"), 8 mm



**Dautrey-Munro Osteotome**

Catalog #	Size, Width
OM-626-04	16 cm (6 1/4"), 4.0 mm
OM-626-06	16 cm (6 1/4"), 6.0 mm
OM-626-08	16 cm (6 1/4"), 8.0 mm
OM-626-10	16 cm (6 1/4"), 10.0 mm
OM-626-12	16 cm (6 1/4"), 12.0 mm
OM-626-14	16 cm (6 1/4"), 14.0 mm
OM-626-16	16 cm (6 1/4"), 16.0 mm



**Dunn-Dautrey Osteotome**

Straight

Catalog #	Size, Width
OM-628-04	16.5 cm (6 1/2"), 4.0 mm
OM-628-06	16 cm (6 1/4"), 6.0 mm
OM-628-08	16 cm (6 1/4"), 8.0 mm



**Dunn-Dautrey Osteotome**

Slightly Curved

Catalog #	Size, Width
OM-629-06	16 cm (6 1/4"), 6.0 mm

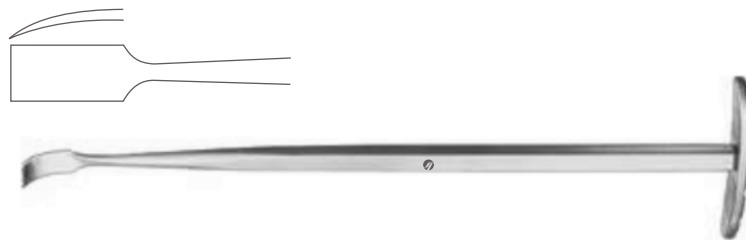

**Dunn-Dautrey Osteotome**

Strongly Curved

Catalog #	Size, Width
OM-631-06	16 cm (6 1/4"), 6.0 mm

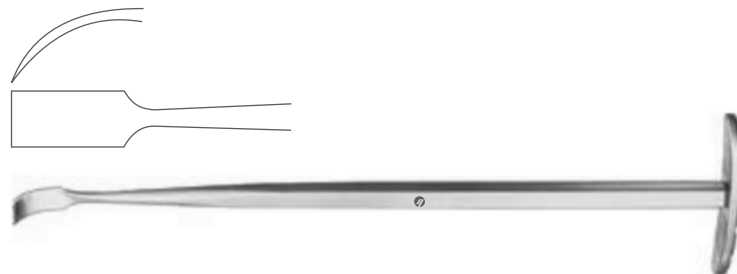



Maxillofacial Instruments  
MKG-Instrumente  
Instrumentos Maxilofaciales  
Instruments Maxilla  
Maxillofacciali Instruments

**Dunn-Dautrey Elevator**

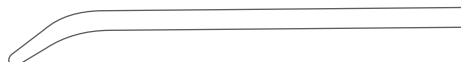

Catalog #	Size, Blade Size
OM-633-48	15.5 cm (6"), 6 x 48 mm
OM-633-56	15.5 cm (6"), 6 x 56 mm

**Dolwick-Type TMJ Disc Clamp**



Catalog #	Size
OM-637-12	12 cm (4 3/4")

**Dolwick-Type TMJ Condylar Retractor**



Catalog #	Size
OM-639-14	14.5 cm (5 1/2")

**Dolwick-Type TMJ Elevator**



Catalog #	Size
OM-641-17	16 cm (6 3/4")

**Turvey Palatal Expander**



Catalog #	Size
OM-700-17	17 cm (6 3/4")

INCHES  
MILLIMETERS



**Terry Septal Osteotome**

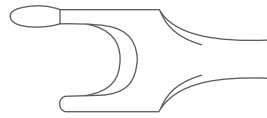

Catalog #	Size
OM-730-19	19 cm (7 1/2")

**Obwegeser Septonasal Osteotome**  
Graduated

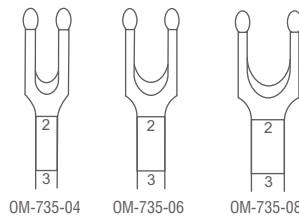

Catalog #	Size, Blade Width
OM-735-04	18.5 cm (7 1/4"), 4 mm
OM-735-06	18.5 cm (7 1/4"), 6 mm
OM-735-08	18.5 cm (7 1/4"), 8 mm

**FiberGrip™ Obwegeser Wedge Osteotome**

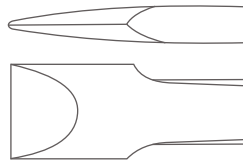

Catalog #	Size, Blade Width
OM-740-08	22 cm (8 3/4"), 8 mm
OM-740-12	22 cm (8 3/4"), 12 mm
OM-747-16	22 cm (8 3/4"), 16 mm

**FiberGrip™ Obwegeser Split Osteotome**

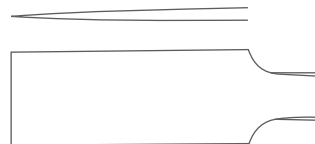

Catalog #	Size, Blade Width
OM-742-08	22 cm (8 3/4"), 8 mm
OM-742-12	22 cm (8 3/4"), 12 mm
OM-742-16	22 cm (8 3/4"), 16 mm
OM-742-20	22 cm (8 3/4"), 20 mm



Osteotomes  
Osteotome  
Osteótomos  
Ostéotomes  
Osteotomi

**Obwegeser Osteotome**  
For Alveolar Process

Catalog #	Size, Blade Width
OM-750-03	15 cm (6"), 3 mm
OM-750-04	15 cm (6"), 4 mm
OM-750-06	15 cm (6"), 6 mm



INCHES  
MILLIMETERS



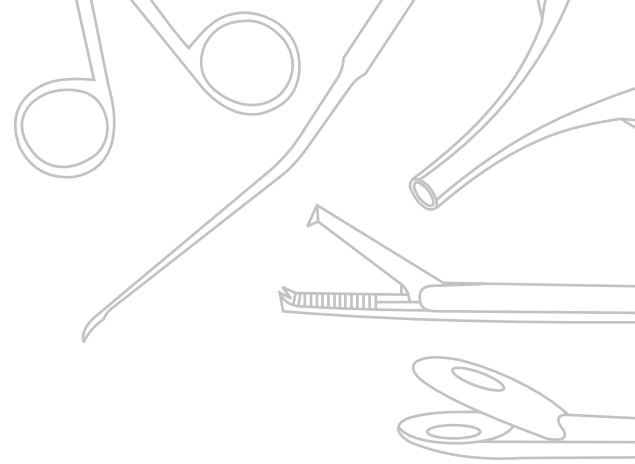

**SURTEX**  
INSTRUMENTS

*Crafted to Excellence*

OT



## OTOLOGY INSTRUMENTS

Surtex Otology Instruments provide innovative tools for a broad range of otology procedures, as well as neurology and lateral skull base surgeries.

Surtex instruments manufactures a range of otology instruments for this branch of medicine including but not limited to the following ear speculums, tuning forks, ear catheters, ear polypus snares, ear forceps, ear polypus forceps, alligator forceps, micro alligator forceps, micro ear scissors, micro ear knives, micro ear needles, ear picks, ear hooks, micro ear instruments, micro ear curettes, ear curettes, scoops, loops, ear hooks, Tympanum needles and knives, periosteal elevators, foreign body levers, mastoid rongeurs and ear syringes.

Otologie

Otologia

Otologie

Otologia



Ear Specula  
Ohrspekula  
Espéculos auriculares  
Spéculums auriculaires  
Specoli auricolari

**Hartmann Ear Specula**  
Set of 3 Ref: OT-012-00 to OT-012-02

Catalog #	Size
OT-010-01	Standard



**Hartmann Ear Specula**  
Set of 3 Ref: OT-012-02 to OT-012-04

Catalog #	Size
OT-010-02	Standard



**Hartmann Ear Specula**  
Set of 3 Ref: OT-012-01 to OT-012-04

Catalog #	Size
OT-010-03	Standard



**Hartmann Ear Specula**  
Set of 3 Ref: OT-012-00 to OT-012-04

Catalog #	Size
OT-010-03	Standard



**Hartmann Ear Speculum**

Catalog #	Size, Diameter, Profile
OT-012-00	3.6 cm (1 1/2"), Ø 3.0 mm, Fig. 0
OT-012-01	3.6 cm (1 1/2"), Ø 4.0 mm, Fig. 1
OT-012-02	3.6 cm (1 1/2"), Ø 5.0 mm, Fig. 2
OT-012-03	3.6 cm (1 1/2"), Ø 6.0 mm, Fig. 3
OT-012-04	3.6 cm (1 1/2"), Ø 7.0 mm, Fig. 4





Ear Specula  
Ohrspekula  
Espéculos auriculares  
Spéculums auriculaires  
Specoli auricolari

**Toynbee Ear Specula**

Set of 3 Ref: OT-022-02 to OT-022-04



Catalog #	Size
OT-020-01	Standard



**Toynbee Ear Specula**

Set of 4 Ref: OT-022-01 to OT-022-04



Catalog #	Size
OT-020-02	Standard



**Toynbee Ear Speculum**

For Adults



Catalog #	Size
OT-022-01	3.6 cm (1 1/2"), Ø 4.0 mm, Fig. 1
OT-022-02	3.6 cm (1 1/2"), Ø 5.0 mm, Fig. 2
OT-022-03	3.6 cm (1 1/2"), Ø 6.0 mm, Fig. 3
OT-022-04	3.6 cm (1 1/2"), Ø 7.0 mm, Fig. 4



**Hartmann Ear Specula (Black)**

Set of 3 Ref: OT-032-00 to OT-032-02

Catalog #	Size
OT-030-01	Standard



**Hartmann Ear Specula (Black)**

Set of 3 Ref: OT-032-02 to OT-032-04

Catalog #	Size
OT-030-02	Standard





Ear Specula  
Ohrspekula  
Espéculos auriculares  
Spéculums auriculaires  
Specoli auricolari

**Hartmann Ear Specula (Black)**

Set of 4 Ref: OT-032-01 to OT-032-04

Catalog #	Size
OT-030-03	Standard



**Hartmann Ear Speculum**  
Black

Catalog #	Size, Profile
OT-032-00	3.6 cm (1 1/2"), Fig. 0
OT-032-01	3.6 cm (1 1/2"), Fig. 1
OT-032-02	3.6 cm (1 1/2"), Fig. 2
OT-032-03	3.6 cm (1 1/2"), Fig. 3
OT-032-04	3.6 cm (1 1/2"), Fig. 4



**Zoellner Ear Specula**

Set of 6 Ref: OT-042-01 to OT-042-06

Catalog #	Size
OT-040-01	Standard

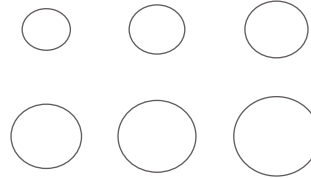

**Zoellner Ear Speculum**  
Oval, Black

Catalog #	Size, Tip Size, Profile
OT-042-01	3.8 cm (1 1/2"), 5.5 x 6.5 mm. Fig. 1
OT-042-02	3.8 cm (1 1/2"), 6.5 x 7.5 mm. Fig. 2
OT-042-03	3.8 cm (1 1/2"), 7.5 x 8.5 mm. Fig. 3
OT-042-04	3.8 cm (1 1/2"), 8.5 x 9.5 mm. Fig. 4
OT-042-05	3.8 cm (1 1/2"), 9.5 x 10.5 mm. Fig. 5
OT-042-06	3.8 cm (1 1/2"), 10.5 x 11.5 mm. Fig. 6





Ear Specula  
Ohrspekula  
Espéculos auriculares  
Spéculums auriculaires  
Specoli auricolari

**Farrior Ear Specula**

Set of 7 Ref: OT-052-01 to OT-052-07

Catalog #	Size
OT-050-01	Standard



**Farrior Ear Speculum**

Black

Catalog #	Size, Diameter, Profile
OT-052-01	3.6 cm (1 1/2"), Ø 5.5 mm, Fig. 1
OT-052-02	3.6 cm (1 1/2"), Ø 6.5 mm, Fig. 2
OT-052-03	3.6 cm (1 1/2"), Ø 7.5 mm, Fig. 3
OT-052-04	3.6 cm (1 1/2"), Ø 8.5 mm, Fig. 4
OT-052-05	3.6 cm (1 1/2"), Ø 9.5 mm, Fig. 5
OT-052-06	3.6 cm (1 1/2"), Ø 10.5 mm, Fig. 6
OT-052-07	3.6 cm (1 1/2"), Ø 11.5 mm, Fig. 7



**Storage Rack for Ear Specula**

For 12 Specula

Catalog #	Size
OT-060-12	Standard



**Richnau-Holmgren Ear Speculum**

Catalog #	Diameter
OT-064-02	Ø 2.0 mm
OT-064-04	Ø 3.0 mm
OT-064-06	Ø 4.0 mm

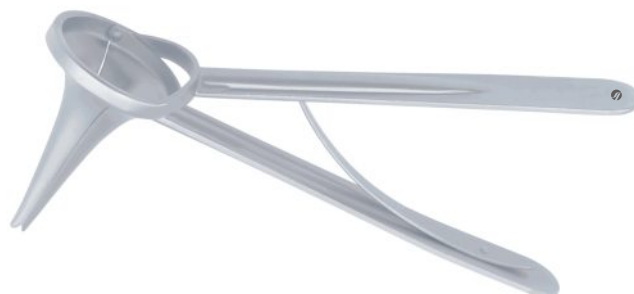



Ear Specula, Tuning Forks  
Ohrspekula, Stimmgabeln  
Espéculos auriculares, Diapasónes  
Spéculums auriculaires, Diapasons  
Specoli auricolari, Diapason

**Siegle Otoscope Complete**

With 3 Specula Ref: OT-072-01 to OT-072-03

Catalog #	Size
OT-070-00	Standard



**Siegle Ear Speculum**

Catalog #	Diameter, Profile
OT-072-01	Ø 6.5 mm, Fig. 1
OT-072-02	Ø 7.0 mm, Fig. 2
OT-072-03	Ø 8.0 mm, Fig. 3



OT-072-01



OT-072-02



OT-072-03

**Hartmann Tuning Forks**

Set of 5 Ref: OT-102-03 to OT-102-05 and OT-104-04 to OT-104-05

Catalog #	Size
OT-100-10	Standard



**Hartmann Tuning Forks**

Set of 6 Ref:- OT-102-03 to OT-102-06 and OT-104-04 to OT-104-05

Catalog #	Size
OT-100-20	Standard



**Hartmann Tuning Forks**

Set of 6 Ref:- OT-102-03 to OT-102-06 and OT-104-02 to OT-104-05

Catalog #	Size
OT-100-30	Standard





Tuning Forks  
Stimmgabeln  
Diapasónes  
Diapasons  
Diapason

**Hartmann Tuning Fork**

Catalog #	Frequency
OT-102-01	C 128
OT-102-02	C <sup>1</sup> 256
OT-102-03	C <sup>1</sup> 512
OT-102-04	C <sup>2</sup> 1024
OT-102-05	C <sup>3</sup> 2048
OT-102-06	C <sup>4</sup> 4096



**Hartmann Tuning Fork (French)**

Catalog #	Frequency
OT-104-01	C <sup>2</sup> 16
OT-104-02	C <sup>1</sup> 32
OT-104-03	C 64
OT-104-04	C 128
OT-104-05	C <sup>1</sup> 256



**Tuning Forks**

Set of 5 Ref:- OT-112-02 to OT-112-06

Catalog #	Size
OT-110-00	Standard





Tuning Forks  
Stimmgabeln  
Diapasónes  
Diapasons  
Diapason

**Tuning Fork**

Catalog #	Frequency
OT-112-02	C 128
OT-112-03	C <sup>1</sup> 256
OT-112-04?	C <sup>2</sup> 512
OT-112-05	C <sup>3</sup> 1024
OT-112-06	C <sup>4</sup> 2048



**Lucae Tuning Fork**

Catalog #	Frequency
OT-122-01	C 128
OT-122-02	C <sup>1</sup> 256
OT-122-03	C <sup>2</sup> 512
OT-122-04?	C <sup>3</sup> 1024
OT-122-05	C <sup>4</sup> 2048
OT-122-06	C <sup>5</sup> 4096



**Lucae Tuning Fork**  
Moveable Up to h

Catalog #	Frequency
OT-126-00	C 128



**Hartmann Tuning Fork**  
Moveable up to h

Catalog #	Frequency
OT-128-00	C 128

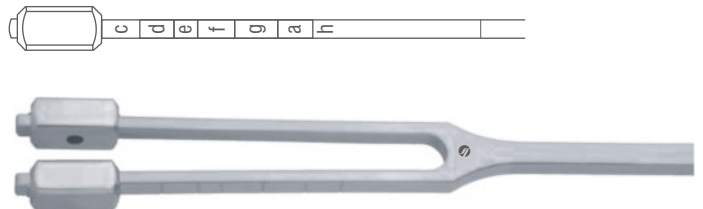





Tuning Forks  
Stimmgabeln  
Diapasónes  
Diapasons  
Diapason

**Hartmann Tuning Fork**



Catalog #	Frequency
OT-130-00	C <sup>1</sup> 256

**Rydel-Seiffer Tuning Fork**  
Also for Neurology



Catalog #	Frequency With Dampers, Frequency Without Dampers
OT-134-00	C 64 , C 128

**Neuro Tuning Fork**  
With Hammer, Pinwheel, Brush and Needle



Catalog #	Frequency
OT-136-00	Standard

**Koenig Tuning Fork**  
Moveable Up to g



Catalog #	Frequency
OT-138-00	A 109

**Tuning Fork**



Catalog #	Frequency
OT-140-00	a <sup>1</sup> 440



Ear Catheters, Polypus Snares  
Ohrkatheter, Polypenschnürer  
Sondas auriculares, Polipótomos  
Sondes auriculaires, Serre-noeuds  
Sonde auricolari, Serranodi

**Hartmann Ear Catheter**



Catalog #	Size, Profile
OT-150-01	15 cm (6"), Fig. 1
OT-150-02	15 cm (6"), Fig. 2
OT-150-03	15 cm (6"), Fig. 3

**Krause Polypus Snare**  
Open Tip



Catalog #	Size
OT-161-18	18.5 cm (7 1/4")

**Krause-Voss Polypus Snare**  
Close Tip



Catalog #	Size
OT-163-18	18.5 cm (7 1/4")

**Lange-Wilde Polypus Snare**



Catalog #	Size
OT-165-16	16 cm (6 1/4")

**Snare Wire**



Catalog #	Size, Diameter
OT-170-30	100 cm (39 1/2"), Ø 0.3 mm
OT-170-40	100 cm (39 1/2"), Ø 0.4 mm



Ear Forceps, Ear Polypus Forceps  
Ohrpinzetten, Ohrpolypenzangen  
Pinzas auriculares, Pinzas para pólipos auriculares  
Pincès auriculaires, Pincès pour polypes auriculaires  
Pinze auricolari, Pinze per polipi auricolari

**Troeltsch (Wilde) Ear Forcep**

Catalog #	Size
OT-201-11	11 cm (4 3/4")
OT-201-13	12.5cm (5")

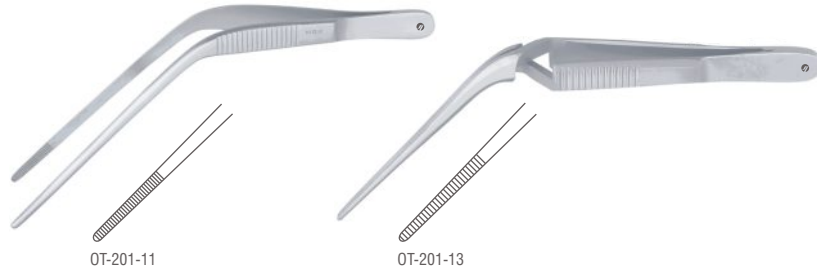

**Troeltsch (Wilde) Ear Forcep**

Catalog #	Size
OT-203-11	11 cm (4 3/4")



**Troeltsch (Wilde) Ear Forcep**  
1 x 2 Teeth

Catalog #	Size
OT-205-11	11 cm (4 3/4")



**Adson Ear Forcep**  
Bayonet Shaped

Catalog #	Size
OT-207-18	17.5 cm (7")



**Gruenwald (Lucae) Ear Forcep**  
Bayonet Shaped

Catalog #	Size
OT-211-14	14.5 cm (5 3/4")





Ear Forceps, Ear Polypus Forceps  
Ohrpinzetten, Ohrpolypenzangen  
Pinzas auriculares, Pinzas para pólipos auriculares  
Pincès auriculaires, Pincès pour polypes auriculaires  
Pinze auricolari, Pinze per polipi auricolari

**Jansen Ear Forcep**  
Bayonet Shaped

Catalog #	Size
OT-213-16	16 cm (6 1/4")
OT-213-21	21.5 cm (8 1/2")



**Gruenwald (Lucae) Ear Forcep**  
1 x 2 Teeth, Bayonet Shaped

Catalog #	Size
OT-215-14	14.5 cm (5 3/4")



**Littauer Ear Polypus Forcep**

Catalog #	Size
OT-221-10	10 cm (4")

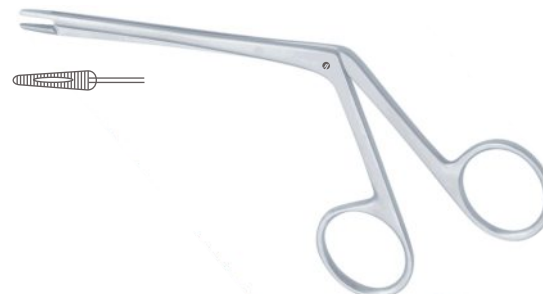

**Hartmann Ear Polypus Forcep**  
Fine Model

Catalog #	Size
OT-223-12	12 cm (4 3/4")



**Hartmann Ear Polypus Forcep**  
Regular Model

Catalog #	Size
OT-225-14	14 cm (5 1/2")





Ear Forceps, Ear Polypus Forceps  
Ohrpinzetten, Ohrpolypenzangen  
Pinzas auriculares, Pinzas para pólipos auriculares  
Pincès auriculaires, Pincès pour polypes auriculaires  
Pinze auricolari, Pinze per polipi auricolari

**Tilley Ear Polypus Forcep**

Catalog #	Size
OT-229-14	14 cm (5 1/2")
OT-229-16	16 cm (6 1/4")



**Buck Foreign Body Forcep**

Catalog #	Size
OT-235-11	11.5 cm (4 1/2")



**Quire Foreign Body Forcep**

Catalog #	Size
OT-237-10	10.5 cm (4")

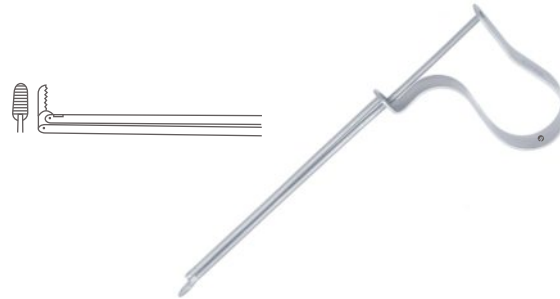

**Hartmann-Wullstein Alligator Forcep**

Catalog #	Size
OT-251-08	8.5 cm (3 1/4")



**Hartmann-Wullstein Alligator Forcep  
Cup Shaped**

Catalog #	Size, Diameter
OT-253-08	8.5 cm (3 1/4"), Ø 1.0 mm





Ear Forceps, Ear Polypus Forceps  
Ohrpinzetten, Ohrpolypenzangen  
Pinzas auriculares, Pinzas para pólipos auriculares  
Pincès auriculaires, Pincès pour polypes auriculaires  
Pinze auricolari, Pinze per polipi auricolari

**Hartmann Alligator Forcep**



Catalog #	Size
OT-255-08	8.5 cm (3 1/4")
OT-255-14	14 cm (5 1/2")
OT-255-16	16 cm (6 1/4")

**Hartmann Alligator Forcep**

1 x 2 Teeth



Catalog #	Size
OT-257-08	8.5 cm (3 1/4")
OT-257-14	14 cm (5 1/2")

**Hartmann Alligator Forcep**

Cup Shaped



Catalog #	Size, Diameter
OT-261-20	8.5 cm (3 1/4"), Ø 2.0 mm
OT-261-25	8.5 cm (3 1/4"), Ø 2.5 mm
OT-261-30	8.5 cm (3 1/4"), Ø 3.0 mm

**Hartmann Alligator Forcep**

Bent Upwards, Cup Shaped



Catalog #	Size, Diameter
OT-263-20	8.5 cm (3 1/4"), Ø 2.0 mm
OT-263-30	8.5 cm (3 1/4"), Ø 3.0 mm

INCHES  
MILLIMETERS



Ear Forceps, Ear Polypus Forceps, Micro Ear Forceps  
Ohrpinzetten, Ohrpolypenzangen, Mikro-Ohrzängchen  
Pinzas auriculares, Pinzas para pólipos auriculares, Micro pinzas auriculares  
Pincès auriculaires, Pincès pour polypes auriculaires, Micro Pince auriculaires  
Pinze auricolari, Pinze per polipi auricolari, Micro Pinze auricolari

**Struempel Alligator Forcep**



Catalog #	Size
OT-265-08	8.5 cm (3 1/4")

**Hartmann-Weingartner Alligator Forcep**



Catalog #	Size
OT-267-08	8.5 cm (3 1/4")

**Hartmann-Hoffmar Alligator Punch Forcep**



Catalog #	Size
OT-271-08	8.5 cm (3 1/4")

**McGee Micro Alligator Forcep**  
Smooth, Straight



Catalog #	Size, Jaw Size
OT-281-08	8 cm (3"), 4.0 x 0.8 mm

**McGee Micro Alligator Forcep**  
Serrated, Straight



Catalog #	Size, Jaw Size
OT-283-08	8 cm (3"), 4.0 x 0.8 mm



Micro Ear Forceps  
Mikro-Ohrzängchen  
Micro pinzas auriculares  
Micro Pince auriculaires  
Micro Pinze auricolari

**McGee Micro Alligator Forcep**  
Serrated, Bent Upwards



Catalog #	Size, Jaw Size
OT-285-08	8 cm (3"), 4.0 x 0.8 mm

**McGee Micro Alligator Forcep**  
Serrated, Right



Catalog #	Size, Jaw Size
OT-287-08	8 cm (3"), 4.0 x 0.8 mm

**McGee Micro Alligator Forcep**  
Serrated, Left



Catalog #	Size, Jaw Size
OT-289-08	8 cm (3"), 4.0 x 0.8 mm

**Mini-McGee Micro Alligator Forcep**  
Smooth, Straight



Catalog #	Size, Jaw Size
OT-291-08	8 cm (3"), 3.5 x 0.6 mm

**Mini-McGee Micro Alligator Forcep**  
Serrated, Straight



Catalog #	Size, Jaw Size
OT-293-08	8 cm (3"), 3.5 x 0.6 mm





Micro Ear Forceps  
Mikro-Ohrzängchen  
Micro pinzas auriculares  
Micro Pince auriculaires  
Micro Pinze auricolari

**Micro Alligator Forcep**  
Smooth, Straight



Catalog #	Size, Jaw Size
OT-301-08	8 cm (3"), 4.0 x 0.6 mm

**Micro Alligator Forcep**  
Serrated, Straight



Catalog #	Size, Jaw Size
OT-303-08	8 cm (3"), 4.0 x 0.6 mm

**Micro Alligator Forcep**  
Serrated, Bent Upwards



Catalog #	Size, Jaw Size
OT-305-08	8 cm (3"), 4.0 x 0.6 mm

**Micro Alligator Forcep**  
Serrated, Right



Catalog #	Size, Jaw Size
OT-307-08	8 cm (3"), 4.0 x 0.6 mm

**Micro Alligator Forcep**  
Serrated, Left



Catalog #	Size, Jaw Size
OT-309-08	8 cm (3"), 4.0 x 0.6 mm



Micro Ear Forceps  
Mikro-Ohrzängchen  
Micro pinzas auriculares  
Micro Pince auriculaires  
Micro Pinze auricolari

**Micro Alligator Forcep**  
Straights, Cup Shaped

Catalog #	Size, Cup Size, Jaw Size
OT-311-08	8 cm (3"), 1.0 x 0.9 mm, 4.0 mm



**Micro Alligator Forcep**  
Bent Upwards, Cup Shaped

Catalog #	Size, Cup Size, Jaw Size
OT-313-08	8 cm (3"), 1.0 x 0.9 mm, 4.0 mm



**Micro Alligator Forcep**  
Right, Cup Shaped

Catalog #	Size, Cup Size, Jaw Size
OT-315-08	8 cm (3"), 1.0 x 0.9 mm, 4.0 mm



**Micro Alligator Forcep**  
Left, Cup Shaped

Catalog #	Size, Cup Size, Jaw Size
OT-317-08	8 cm (3"), 1.0 x 0.9 mm, 4.0 mm



**Micro Alligator Forcep**  
Straight, Cup Shaped

Catalog #	Size, Cup Size, Jaw Size
OT-321-08	8 cm (3"), 0.6 x 0.5 mm, 3.5 mm





Micro Ear Forceps  
Mikro-Ohrzängchen  
Micro pinzas auriculares  
Micro Pince auriculaires  
Micro Pinze auricolari

**Micro Alligator Forcep**  
Bent Upwards, Cup Shaped

Catalog #                      Size, Cup Size, Jaw Size  
OT-323-08                      8 cm (3"), 0.6 x 0.5 mm, 3.5 mm



**Micro Alligator Forcep**  
Right, Cup Shaped

Catalog #                      Size, Cup Size, Jaw Size  
OT-325-08                      8 cm (3"), 0.6 x 0.5 mm, 3.5 mm



**Micro Alligator Forcep**  
Left, Cup Shaped

Catalog #                      Size, Cup Size, Jaw Size  
OT-327-08                      8 cm (3"), 0.6 x 0.5 mm, 3.5 mm



**Bellucci Micro Scissor**  
Straight, Very Fine

Catalog #                      Size, Blade Size  
OT-331-08                      8 cm (3"), 4.0 x 0.8 mm



**Bellucci Micro Scissor**  
Bent Upwards, Very Fine

Catalog #                      Size, Blade Size  
OT-333-08                      8 cm (3"), 4.0 x 0.8 mm





Micro Ear Scissors  
Mikro-Ohrscherchen  
Micro tijeras auriculares  
Micro Ciseaux auriculaires  
Micro Forbici auricolari

**Bellucci Micro Scissor**  
Right, Very Fine

Catalog #	Size, Blade Size
OT-335-08	8 cm (3"), 4.0 x 0.8 mm



**Bellucci Micro Scissor**  
Left, Very Fine

Catalog #	Size, Blade Size
OT-337-08	8 cm (3"), 4.0 x 0.8 mm



**Wullstein Micro Scissor**  
Straight

Catalog #	Size, Blade Size
OT-341-08	8 cm (3"), 4.0 x 1.8 mm



**Wullstein Micro Scissor**  
Bent Upwards

Catalog #	Size, Blade Size
OT-343-08	8 cm (3"), 4.0 x 1.8 mm



**Wullstein Micro Scissor**  
Right

Catalog #	Size, Blade Size
OT-345-08	8 cm (3"), 4.0 x 1.8 mm





Micro Ear Scissors  
Mikro-Ohrscherchen  
Micro tijeras auriculares  
Micro Ciseaux auriculaires  
Micro Forbici auricolari

**Wullstein Micro Scissor**  
Left



Catalog #	Size, Blade Size
OT-347-08	8 cm (3"), 4.0 x 1.8 mm

**Shea Micro Scissor**  
Straight



Catalog #	Size, Blade Size
OT-351-08	8 cm (3"), 7.0 x 1.8 mm

**Shea Micro Scissor**  
Right



Catalog #	Size, Blade Size
OT-355-08	8 cm (3"), 7.0 x 1.8 mm

**Shea Micro Scissor**  
Left



Catalog #	Size, Blade Size
OT-357-08	8 cm (3"), 7.0 x 1.8 mm

**McGee Wire Bending Forcep**  
Bent Downwards



Catalog #	Size, Jaw Size
OT-361-01	8 cm (3"), 3.5 x 0.8 mm
OT-361-02	8 cm (3"), 3.5 x 0.8 mm



Micro Ear Forceps, Micro Ear Knives  
 Mikro-Ohrzängchen, Mikro-Ohrmesser  
 Micro pinzas auriculares, Micro cuchillos auriculares  
 Micro Pince auriculaires, Micro Couteaux auriculaires  
 Micro Pinze auricolari, Micro Coltelli

**House-Dieter Malleus Nipper**

Catalog #	Size, Jaw Opening, Profile
OT-365-01	8 cm (3"), 1.3 mm, Up Cutting
OT-365-02	8 cm (3"), 1.3 mm, Down Cutting



**House-Dieter Malleus Nipper**

Catalog #	Size, Jaw Opening, Profile
OT-365-03	8 cm (3"), 1.3 mm, Right Cutting
OT-365-04	8 cm (3"), 1.3 mm, Left Cutting



**Fuller Introducing Forcep  
 For Teflon Prosthesis**

Catalog #	Size
OT-367-08	8 cm (3")

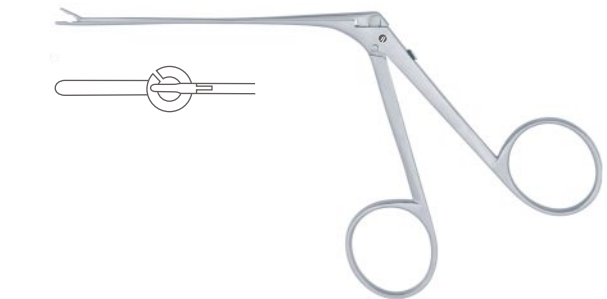

**Schuknecht Rotary Knife**

Catalog #	Size
OT-401-01	15 cm (6")
OT-401-02	15 cm (6")



**Schuknecht Sickle Knife**

Catalog #	Size
OT-403-15	14.5 cm (5 3/4")



INCHES  
MILLIMETERS



Micro Ear Knives  
Mikro-Ohrmesser  
Micro cuchillos auriculares  
Micro Couteaux auriculaires  
Micro Coltelli

**Wullstein Sickle Knife**



Catalog #	Size
OT-405-15	15.5 cm (6")

**Tabb Mucosa Knife**



Catalog #	Size
OT-407-15	15.5 cm (6")

**Plester Flap Knife**



Catalog #	Size
OT-409-15	15 cm (6")

**Plester Sickle Knife**



Catalog #	Size
OT-415-15	15 cm (6")

**Sexton Myringotomy Knife**



Catalog #	Size
OT-417-15	15 cm (6")



Micro Ear Knives, Micro Ear Hooks  
Mikro-Ohrmesser, Mikro-Ohrhäkchen  
Micro cuchillos auriculares, Micro ganchitos auriculares  
Micro Couteaux auriculaires, Micro Crochets auriculaires  
Micro Coltelli, Micro Uncini auricolari

**Rosen Circular Cut Knife**



Catalog #	Size, Diameter, Profile
OT-421-01	15 cm (6"), Ø 3.0 mm, Fig. 1
OT-421-02	15 cm (6"), Ø 2.8 mm, Fig. 2
OT-421-03	15 cm (6"), Ø 2.6 mm, Fig. 3
OT-421-04	15 cm (6"), Ø 2.0 mm, Fig. 4
OT-421-05	15 cm (6"), Ø 1.6 mm, Fig. 5
OT-421-06	15 cm (6"), Ø 1.4 mm, Fig. 6
OT-421-07	15 cm (6"), Ø 1.0 mm, Fig. 7



**Barbara Micro Ear Pick**



Catalog #	Size
OT-450-16	16 cm (6 1/4")

**Barbara Micro Ear Pick  
Angled**



Catalog #	Size
OT-451-16	16 cm (6 1/4")

**Barbara Micro Ear Pick**



Catalog #	Size
OT-453-16	16 cm (6 1/4")

**Rosen Micro Ear Pick**



Catalog #	Size
OT-455-16	16 cm (6 1/4")





Micro Ear Hooks, Micro Ear Needles  
Mikro-Ohrhäkchen, Mikro-Ohrnadeln  
Micro ganchitos auriculares, Micro agujas auriculares  
Micro Crochets auriculaires, Micro Aiguilles auriculaires  
Micro Uncini auricolari, Micro Aghi auricolari

**Barbara Micro Ear Pick**  
Angled 25°



Catalog #	Size, Tip Size
OT-459-03	16 cm (6 1/4"), 0.3 mm
OT-459-06	16 cm (6 1/4"), 0.6 mm
OT-459-10	16 cm (6 1/4"), 1.0 mm

**Barbara Micro Ear Pick**  
Angled 45°



Catalog #	Size, Tip Size
OT-461-03	16 cm (6 1/4"), 0.3 mm
OT-461-06	16 cm (6 1/4"), 0.6 mm
OT-461-10	16 cm (6 1/4"), 1.0 mm
OT-461-12	16 cm (6 1/4"), 1.2 mm
OT-461-15	16 cm (6 1/4"), 1.5 mm
OT-461-20	16 cm (6 1/4"), 2.0 mm
OT-461-25	16 cm (6 1/4"), 2.5 mm

**Barbara Micro Ear Pick**  
Angled 90°



Catalog #	Size, Tip Size
OT-463-03	16 cm (6 1/4"), 0.3 mm
OT-463-06	16 cm (6 1/4"), 0.6 mm
OT-463-10	16 cm (6 1/4"), 1.0 mm
OT-463-12	16 cm (6 1/4"), 1.2 mm
OT-463-15	16 cm (6 1/4"), 1.5 mm
OT-463-20	16 cm (6 1/4"), 2.0 mm
OT-463-25	16 cm (6 1/4"), 2.5 mm



Micro Ear Hooks, Micro Ear Needles  
 Mikro-Ohrhäkchen, Mikro-Ohrnadeln  
 Micro ganchitos auriculares, Micro agujas auriculares  
 Micro Crochets auriculaires, Micro Aiguilles auriculaires  
 Micro Uncini auricolari, Micro Aghi auricolari

**Barbara Micro Ear Needle**  
 Curved Down



Catalog #	Size, Tip Size
OT-465-05	16 cm (6 1/4"), 0.5 mm
OT-465-10	16 cm (6 1/4"), 1.0 mm



**Micro Ear Needle**  
 Angled 90°



Catalog #	Size, Tip Size
OT-467-03	15.5 cm (6"), 0.3 mm
OT-467-06	15.5 cm (6"), 0.6 mm
OT-467-10	15.5 cm (6"), 1.0 mm



**Micro Ear Needle**  
 Angled 90°



Catalog #	Size, Tip Size
OT-469-03	15.5 cm (6"), 0.3 mm
OT-469-06	15.5 cm (6"), 0.6 mm
OT-469-10	15.5 cm (6"), 1.0 mm



**McGee Micro Ear Needle**  
 For Footplate



Catalog #	Size, Tip Size
OT-473-05	15.5 cm (6"), 0.5 mm
OT-473-10	15.5 cm (6"), 1.0 mm





Micro Ear Hooks, Micro Ear Needles  
Mikro-Ohrhäkchen, Mikro-Ohrnadeln  
Micro ganchitos auriculares, Micro agujas auriculares  
Micro Crochets auriculaires, Micro Aiguilles auriculaires  
Micro Uncini auricolari, Micro Aghi auricolari

**McGee Micro Ear Needle**  
For Footplate

Catalog #	Size, Tip Size
OT-475-05	15.5 cm (6"), 0.5 mm
OT-475-10	15.5 cm (6"), 1.0 mm



**Barbara Micro Ear Needle**

Catalog #	Size
OT-478-16	15.5 cm (6")



**Barbara Micro Ear Pick**

Catalog #	Size
OT-479-16	15.5 cm (6")



**Micro Ear Pick**  
Angled 25°

Catalog #	Size, Tip Size
OT-481-03	15.5 cm (6"), 0.3 mm
OT-481-06	15.5 cm (6"), 0.6 mm
OT-481-10	15.5 cm (6"), 1.0 mm



**Micro Ear Pick**  
Angled 25°

Catalog #	Size, Tip Size
OT-483-03	15.5 cm (6"), 0.3 mm
OT-483-06	15.5 cm (6"), 0.6 mm
OT-483-10	15.5 cm (6"), 1.0 mm





Micro Ear Hooks, Micro Ear Needles  
 Mikro-Ohrhäkchen, Mikro-Ohrnadeln  
 Micro ganchitos auriculares, Micro agujas auriculares  
 Micro Crochets auriculaires, Micro Aiguilles auriculaires  
 Micro Uncini auricolari, Micro Aghi auricolari

**Micro Ear Pick**  
Angled 45°

Catalog #	Size, Tip Size
OT-485-03	15.5 cm (6"), 0.3 mm
OT-485-06	15.5 cm (6"), 0.6 mm
OT-485-10	15.5 cm (6"), 1.0 mm



**Micro Ear Pick**  
Angled 45°

Catalog #	Size, Tip Size
OT-487-03	15.5 cm (6"), 0.3 mm
OT-487-06	15.5 cm (6"), 0.6 mm
OT-487-10	15.5 cm (6"), 1.0 mm



**Micro Ear Needle**  
Angled 25°

Catalog #	Size, Tip Size
OT-491-03	15.5 cm (6"), 0.3 mm
OT-491-06	15.5 cm (6"), 0.6 mm



OT-491-03

OT-491-06

**Shambaugh Micro Ear Needle**  
Angled 25°

Catalog #	Size, Tip Size
OT-491-10	15.5 cm (6"), 1.0 mm





Micro Ear Hooks, Micro Dissectors  
Mikro-Ohrhäkchen, Mikro-Dissektoren  
Micro ganchitos auriculares, Micro disecadores  
Micro Crochets auriculaires, Micro Dissecteurs  
Micro Uncini auricolari, Micro Dissettori

**Micro Ear Needle**  
Angled 45°



Catalog #	Size, Tip Size
OT-493-03	15.5 cm (6"), 0.3 mm
OT-493-06	15.5 cm (6"), 0.6 mm



**Shambaugh Micro Ear Needle**  
Angled 45°



Catalog #	Size, Tip Size
OT-493-10	15.5 cm (6"), 1.0 mm



**Shea Exploring Hook**  
Angled 45°, Blunt



Catalog #	Size, Tip Size
OT-497-20	15.5 cm (6"), 2.0 mm



**Austin Attic Dissector**  
Angled 90°, Blunt



Catalog #	Size, Tip Size
OT-501-30	15.5 cm (6"), 3.0 mm



**Fisch Micro Dissector**



Catalog #	Size, Profile
OT-505-01	15.5 cm (6"), Angled to Right
OT-505-02	15.5 cm (6"), Angled to Left
OT-505-03	15.5 cm (6"), Angled to Right
OT-505-04	15.5 cm (6"), Angled to Left

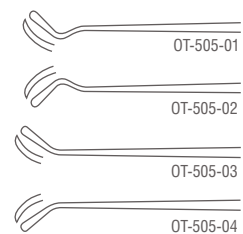



Micro Curettes, Micro Dissectors, Micro Measuring Rods  
 Mikro-Küretten, Mikro-Dissektoren, Mikro-Messsonden  
 Micro cucharillas, Micro disecadores, Micro Sondas para medir  
 Micro Curettes, Micro Dissecteurs, Micro Sondes pour mesurer  
 Micro cucchiari, Micro Dissettori, Micro Sonde per misurare

**Rosen Micro Ear Periosteal Elevator**



Catalog #	Size
OT-509-01	15.5 cm (6")
OT-509-02	15.5 cm (6")
OT-509-03	15.5 cm (6")

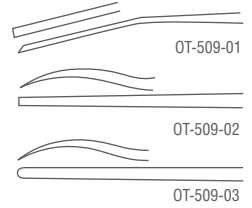

**Rosen Micro Curette**



Catalog #	Size
OT-509-04	15.5 cm (6")

**Rosen Micro Dissector**



Catalog #	Size
OT-509-05	15.5 cm (6")
OT-509-06	15.5 cm (6")

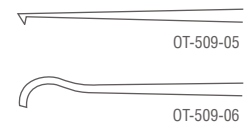

**House Micro Measuring Rod**



Catalog #	Size, Tip Size
OT-511-01	15.5 cm (6"), 3.5 mm
OT-511-02	15.5 cm (6"), 4.0 mm
OT-511-03	15.5 cm (6"), 4.5 mm
OT-511-04	15.5 cm (6"), 5.0 mm

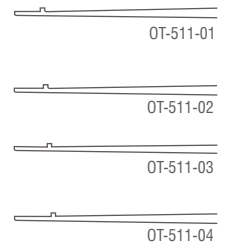



Micro Curettes  
Mikro-Küretten  
Micro cucharillas  
Micro Curettes  
Micro cucchiari

**Buckingham Chisel**

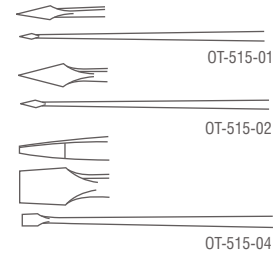

Catalog #	Size, Tip Size
OT-515-01	18 cm (7"), 0.5 mm
OT-515-02	18 cm (7"), 1.0 mm
OT-515-04	18 cm (7"), 1.5 mm

**Dingmann Otoprader**

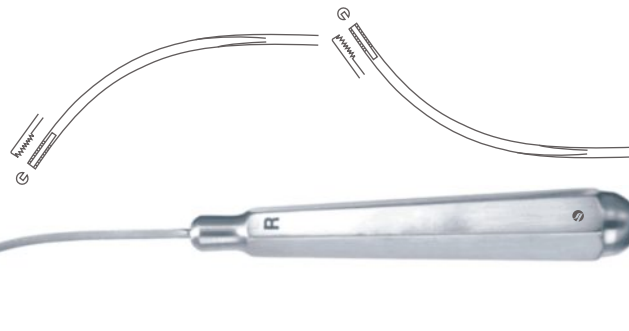

Catalog #	Profile
OT-517-01	Left
OT-517-02	Right

**House Micro Ear Curette**

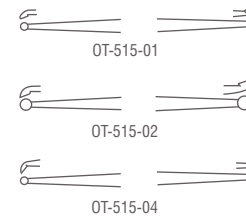

Catalog #	Size, Cup Size 1, Cup Size 2
OT-520-01	14.5 cm (5 3/4"), 1.0 mm, 1.2 mm
OT-520-02	14.5 cm (5 3/4"), 1.5 mm, 1.8 mm
OT-520-03	14.5 cm (5 3/4"), 1.0 mm, 1.2 mm
OT-520-04	14.5 cm (5 3/4"), 1.5 mm, 1.8 mm

**Shea Micro Ear Curette**



Catalog #	Size
OT-525-14	14.5 cm (5 3/4")



Micro Dissectors  
Mikro-Dissektoren  
Micro disecadores  
Micro Dissecteurs  
Micro Dissettori

**Zoellner Micro Ear Needle**  
Straight



Catalog #	Size
OT-535-01	13.5 cm (5 1/2")

**Zoellner Micro Ear Needle**  
Angled 45° Upwards

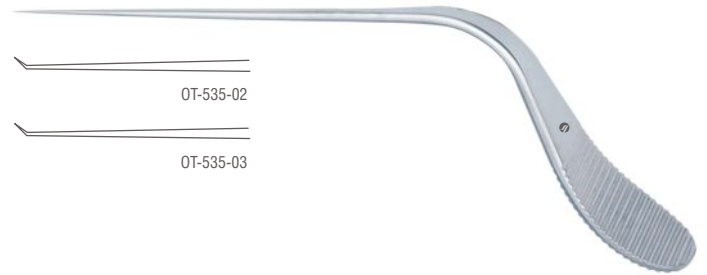

Catalog #	Size, Tip Size
OT-535-02	13.5 cm (5 1/2"), 0.5 mm
OT-535-03	13.5 cm (5 1/2"), 1.0 mm

**Zoellner Micro Ear Needle**  
Angled 45° Downwards

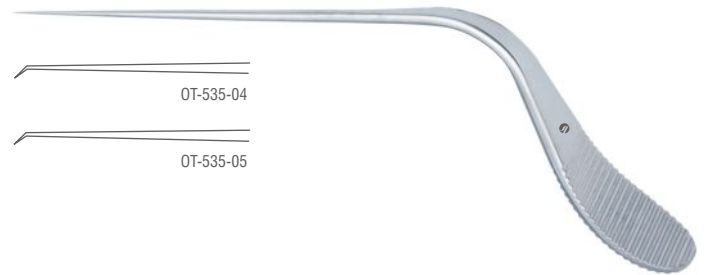

Catalog #	Size, Tip Size
OT-535-04	13.5 cm (5 1/2"), 0.5 mm
OT-535-05	13.5 cm (5 1/2"), 1.0 mm

**Zoellner Micro Ear Needle**  
Angled 90° Upwards



Catalog #	Size, Tip Size
OT-535-06	13.5 cm (5 1/2"), 0.5 mm

**Zoellner Micro Ear Needle**  
Angled 90° Downwards



Catalog #	Size, Tip Size
OT-535-07	13.5 cm (5 1/2"), 0.5 mm





Micro Dissectors  
Mikro-Dissektoren  
Micro disecadores  
Micro Dissecteurs  
Micro Dissettori

**Zoellner Micro Ear Needle**  
For Footplate

Catalog #	Size, Tip Size
OT-535-08	13.5 cm (5 1/2"), 1.0 mm
OT-535-09	13.5 cm (5 1/2"), 1.0 mm

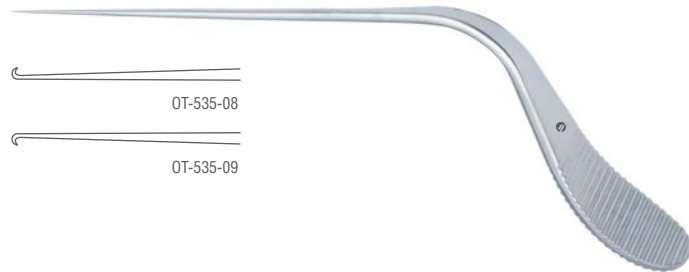

**Zoellner Ear Knife**  
Angled 90° Upwards

Catalog #	Size
OT-535-10	13.5 cm (5 1/2")



**Zoellner Ear Knife**  
Angled 90° Downwards

Catalog #	Size
OT-535-11	13.5 cm (5 1/2")



**Zoellner Micro Ear Knife**  
Angled Upwards

Catalog #	Size
OT-535-12	13.5 cm (5 1/2")



**Zoellner Micro Ear Knife**  
Angled Downwards

Catalog #	Size
OT-535-13	13.5 cm (5 1/2")





Micro Dissectors  
Mikro-Dissektoren  
Micro disecadores  
Micro Dissecteurs  
Micro Dissettori

**Zoellner Tympanum Needle**  
Angled Upwards



Catalog #	Size
OT-535-14	13.5 cm (5 1/2")

**Zoellner Tympanum Needle**  
Angled Downwards



Catalog #	Size
OT-535-15	13.5 cm (5 1/2")

**Zoellner Raspatory**



Catalog #	Size
OT-535-16	13.5 cm (5 1/2")
OT-535-17	13.5 cm (5 1/2")

**Zoellner Application Instrument**



Catalog #	Size
OT-535-18	Standard

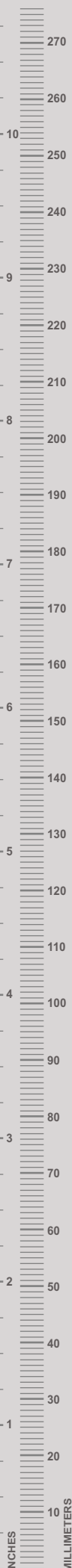



Ear Cures  
Ohrküretten  
Curetas auriculares  
Curettes auriculaires  
Curette auricolari

**Langenbeck Ear Curette**  
Blunt

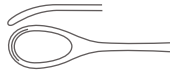

Catalog #	Size
OT-551-13	13 cm (5")

**Shapleigh Ear Curette**



Catalog #	Size, Profile
OT-555-01	15 cm (6"), Fig. 1
OT-555-02	15 cm (6"), Fig. 2

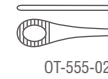

**Buck Ear Curette**  
Straight, Blunt



Catalog #	Size, Profile
OT-570-01	17 cm (6 3/4"), Fig. 000
OT-570-02	17 cm (6 3/4"), Fig. 00
OT-570-10	17 cm (6 3/4"), Fig. 0
OT-570-11	17 cm (6 3/4"), Fig. 1
OT-570-12	17 cm (6 3/4"), Fig. 2
OT-570-13	17 cm (6 3/4"), Fig. 3
OT-570-14	17 cm (6 3/4"), Fig. 4





Ear Curettes  
Ohrküretten  
Curetas auriculares  
Curettes auriculaires  
Curette auricolari

**Buck Ear Curette**  
Angled, Blunt



Catalog #	Size, Profile
OT-571-01	17 cm (6 3/4"), Fig. 000
OT-571-02	17 cm (6 3/4"), Fig. 00
OT-571-10	17 cm (6 3/4"), Fig. 0
OT-571-11	17 cm (6 3/4"), Fig. 1
OT-571-12	17 cm (6 3/4"), Fig. 2
OT-571-13	17 cm (6 3/4"), Fig. 3
OT-571-14	17 cm (6 3/4"), Fig. 4

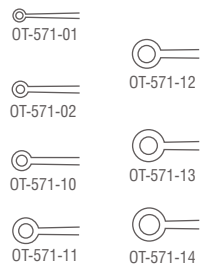

**Buck Ear Curette**  
Straight, Sharp



Catalog #	Size, Profile
OT-572-01	17 cm (6 3/4"), Fig. 000
OT-572-02	17 cm (6 3/4"), Fig. 00
OT-572-10	17 cm (6 3/4"), Fig. 0
OT-572-11	17 cm (6 3/4"), Fig. 1
OT-572-12	17 cm (6 3/4"), Fig. 2
OT-572-13	17 cm (6 3/4"), Fig. 3
OT-572-14	17 cm (6 3/4"), Fig. 4

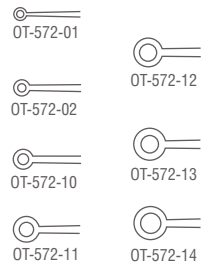

**Buck Ear Curette**  
Angled, Sharp



Catalog #	Size, Profile
OT-573-01	17 cm (6 3/4"), Fig. 000
OT-573-02	17 cm (6 3/4"), Fig. 00
OT-573-10	17 cm (6 3/4"), Fig. 0
OT-573-11	17 cm (6 3/4"), Fig. 1
OT-573-12	17 cm (6 3/4"), Fig. 2
OT-573-13	17 cm (6 3/4"), Fig. 3
OT-573s-14	17 cm (6 3/4"), Fig. 4

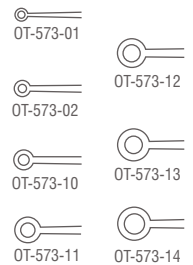



Foreign Body Instruments  
Fremdkörperinstrumente  
Instrumentos para cuerpos extraños  
Instruments pour corps étrangers  
Strumenti per corpi estranei

**Jansen Ear Scoop**  
Sharp



Catalog #	Size
OT-576-15	17 cm (6 3/4")

**Barth Ear Scoop**  
Sharp



Catalog #	Size
OT-580-18	18 cm (7")

**Gross Ear Scoop-Hook**  
Blunt



Catalog #	Size
OT-583-13	13 cm (5")

**Lempert Ear Scoop**  
Sharp



Catalog #	Size, Profile
OT-600-10	21.5 cm (8 1/2"), Fig. 0
OT-600-20	21.5 cm (8 1/2"), Fig. 00
OT-600-30	21.5 cm (8 1/2"), Fig. 000
OT-600-40	21.5 cm (8 1/2"), Fig. 0000
OT-600-50	21.5 cm (8 1/2"), Fig. 00000





Foreign Body Instruments  
Fremdkörperinstrumente  
Instrumentos para cuerpos extraños  
Instruments pour corps étrangers  
Strumenti per corpi estranei

**FiberGrip™ Lempert Ear Scoop**  
Sharp



Catalog #	Size, Profile
OT-610-10	21.5 cm (8 1/2"), Fig. 0
OT-610-20	21.5 cm (8 1/2"), Fig. 00
OT-610-30	21.5 cm (8 1/2"), Fig. 000
OT-610-40	21.5 cm (8 1/2"), Fig. 0000
OT-610-50	21.5 cm (8 1/2"), Fig. 00000



**Weber-Loch Ear Loop**



Catalog #	Size
OT-650-01	16.5 cm (6 1/4")

**Billeau Ear Loop**



Catalog #	Size
OT-660-01	16 cm (6 1/4")
OT-660-02	16 cm (6 1/4")
OT-660-03	16 cm (6 1/4")

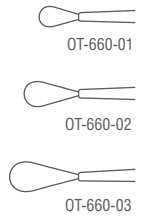

**Hartmann Ear Hook**  
Sharp



Catalog #	Size
OT-671-16	16 cm (6 1/4")



Ear Hooklet, Tympanum Needles  
Ohrhäkchen, Trommelfellnadeln  
Ganchito auricular, Agujas para tímpano  
Levier pour corps étrangers, Instruments pour corps étrangers  
Uncino auricolare, Strumenti per corpi estranei

**Lucae Ear Hook**



Catalog #	Size, Profile
OT-673-01	14 cm (5 1/2"), Small
OT-673-02	14 cm (5 1/2"), Medium
OT-673-03	14 cm (5 1/2"), Large

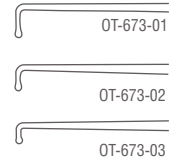

**Wagener Ear Hook**



Catalog #	Size, Point Size, Profile
OT-675-01	14 cm (5 1/2"), 2 mm, Fig. 1
OT-675-02	14 cm (5 1/2"), 2.5 mm, Fig. 2
OT-675-03	14 cm (5 1/2"), 3 mm, Fig. 3
OT-675-04	14 cm (5 1/2"), 3.5 mm, Fig. 4
OT-675-05	14 cm (5 1/2"), 4 mm, Fig. 5

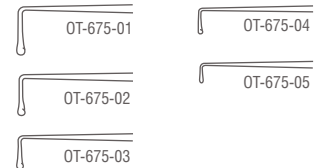

**Day Ear Hook**



Catalog #	Size, Profile
OT-677-01	17 cm (6 3/4"), Long
OT-677-02	17 cm (6 3/4"), Short

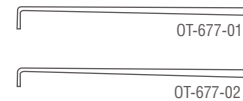

**Seeker**

With Ball Probe, Angled 45°



Catalog #	Size
OT-679-01	15.5 cm (6")



Tympanum Needles  
Trommelfellnadeln  
Agujas para timpano  
Instruments pour corps étrangers  
Strumenti per corpi estranei

**Politzer Furuncle Knife**



Catalog #	Size
OT-701-16	14.5 cm (5 3/4")

**Politzer Tympanum Needle**



Catalog #	Size
OT-704-16	17.5 cm (7")

**Politzer Tympanum Needle**



Catalog #	Size
OT-707-16	15.5 cm (6")

**Politzer Tympanum Needle  
Needle Horizontal**



Catalog #	Size
OT-709-16	16 cm (6 1/4")

**Lucae Tympanum Needle**



Catalog #	Size
OT-711-16	17.5 cm (7")





Ear Periosteal Elevators  
Ohrraspatorien  
Legras auriculares  
Rugines-raspatoires auriculaires  
Raspatori auricolari

**Lucae Tympanum Needle**



Catalog #	Size
OT-713-16	17.5 cm (7")

**Moldnehauser Foreign Body Lever**



Catalog #	Size
OT-721-16	15.5 cm (6")

**Zaufal Foreign Body Lever**



Catalog #	Size
OT-723-16	15 cm (6")

**Lempert Periosteal Elevator**



Catalog #	Size, Width
OT-727-20	20.5 cm (8"), 6 mm

**Lempert Periosteal Elevator**



Catalog #	Size, Width
OT-729-18	18 cm (7"), 6 mm



Mastoid Rongeurs, Ear Syringes  
Ohr-Knochenstanzen, Ohrspritzen  
Pinzas cortantes para huesos, Jeringas auriculares  
Ostéotomes emporte-pièces, Seringues auriculaires  
Pinze osteotomi, Siringhe auricolari

**Lempert Periosteal Elevator**



Catalog #	Size, Width
OT-731-02	17 cm (6 3/4"), 2 mm
OT-731-03	17 cm (6 3/4"), 3 mm
OT-731-04	17 cm (6 3/4"), 4 mm
OT-731-05	17 cm (6 3/4"), 5 mm

**Citelli Mastoid Rongeur**

OT-751-02

OT-751-03



Catalog #	Size, Bite Size
OT-751-02	17 cm (6 3/4"), 2 mm
OT-751-03	17 cm (6 3/4"), 3 mm

**Beyer Mastoid Rongeur**



Catalog #	Size, Bite Size
OT-755-19	19 cm (7 1/2"), 2 mm

**Beyer Mastoid Rongeur**



Catalog #	Size, Bite Size
OT-759-14	14 cm (5 1/2"), 1 mm

**Ear Syringe Complete**

With Protection Disk and 2 Tips



Catalog #	Capacity
OT-800-00	50 ml

INCHES  
MILLIMETERS



Ear Syringes  
Ohrspritzen  
Jeringas auriculares  
Seringues auriculaires  
Siringhe auricolari

**Ear Syringe Complete**

With Protection Disk and 2 Tips

Catalog #	Capacity
OT-802-00	100 ml







**SURTEX**  
INSTRUMENTS

*Crafted to Excellence*



Surtext Rhinology Instruments are meticulously designed and crafted to provide a cleaner and more precise cut, preserve mucosa, and minimize trauma to adjacent structures during sinus surgery.

Surtext range of rhinology instruments cover a broad spectrum and include the following nasal speculums, nasal polypus snares, nasal tampon forceps, nasal polypus forceps, septum forceps, ethmoid forceps, nasal cutting forceps, sphenoidal punches, rhinos plastic knives, septum knives, septum elevators, periosteal elevators, septum chisels, septum osteotomes, septum gouges, nasal saws, cartilage crushers, bone files, nasal rasps, nasal hooks and retractors, septum straightening forceps, antrum curettes, adenoid curettes, adenotomes, irrigation cannulas and sinus dilators.

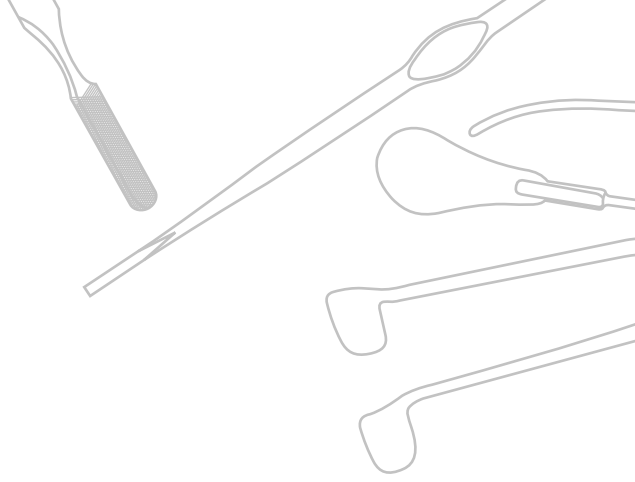

RH

## RHINOLOGY INSTRUMENTS

Rhinologie

Rinología

Rhinologie

Rinologia



Nasal Specula  
Nasenspekula  
Espéculos nasales  
Spéculums nasaux  
Specoli nasali

**Thudichum Nasal Specula**

Set of 3 Ref: RH-012-01 to RH-012-03

Catalog #	Size
RH-011-10	Standard



**Thudichum Nasal Specula**

Set of 4 Ref: RH-012-01 to RH-012-04

Catalog #	Size
RH-011-20	Standard



**Thudichum Nasal Specula**

Set of 3 Ref: RH-012-05 to RH-012-07

Catalog #	Size
RH-011-30	Standard



**Thudichum Nasal Specula**

Set of 7 Ref: RH-012-01 to RH-012-07

Catalog #	Size
RH-011-40	Standard



**Thudichum Nasal Speculum**

Catalog #	Blade Size, Profile
RH-013-01	12 mm , Fig. 1
RH-013-02	14 mm , Fig. 2
RH-013-03	16.5 mm , Fig. 3
RH-013-04	18.5 mm , Fig. 4
RH-013-05	20.5 mm , Fig. 5
RH-013-06	22 mm , Fig. 6
RH-013-07	23 mm , Fig. 7

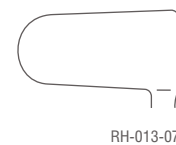
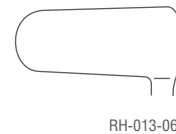



Nasal Specula  
Nasenspekula  
Espéculos nasales  
Spéculums nasaux  
Specoli nasali

**Voltolini Nasal Speculum**

Catalog #	Profile
RH-017-01	Fig. 1
RH-017-02	Fig. 2
RH-017-03	Fig. 3



**Mod. Vienna Nasal Specula**

Set of 3 Ref: RH-023-01 to RH-023-03

Catalog #	Size
RH-021-10	Standard



**Mod. Vienna Nasal Speculum**

Catalog #	Blade Length, Profile
RH-023-01	27 mm, Fig. 1
RH-023-02	31 mm, Fig. 2
RH-023-03	35 mm, Fig. 3



**Hartmann-Halle Nasal Specula**

Set of 3 Ref: RH-033-01 to RH-033-03

Catalog #	Size
RH-031-10	Standard





Nasal Specula  
Nasenspekula  
Espéculos nasales  
Spéculems nasaux  
Specoli nasali

**Hartmann-Halle Nasal Speculum**

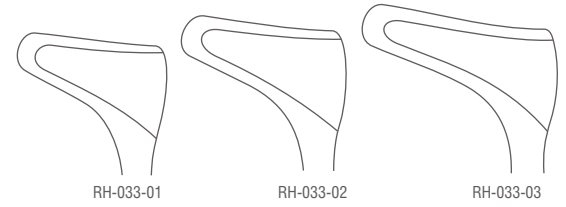

Catalog #	Size, Blade Length, Profile
RH-033-01	15.5 cm (6"), 27 mm, Fig. 1
RH-033-02	15.5 cm (6"), 31 mm, Fig. 2
RH-033-03	15.5 cm (6"), 35 mm, Fig. 3



**Martin Nasal Specula**



Catalog #	Size, Blade Length
RH-035-13	13 cm (5"), 17 mm



**Martin Nasal Specula  
Bent Sidewards**



Catalog #	Size, Blade Length
RH-037-13	12.5 cm (5"), 17 mm



**Tieck-Halle Nasal Specula**



Catalog #	Size, Blade Length
RH-041-13	13 cm (5"), 16 mm



**Killian Nasal Specula**

Set of 4 Ref; RH-053-01 to RH-053-04

Catalog #	Size
RH-051-10	Standard



INCHES  
MILLIMETERS





Nasal Specula  
Nasenspekula  
Espéculos nasales  
Spéculums nasaux  
Specoli nasali

**Killian Nasal Speculum**

Catalog #	Size, Blade Length, Profile
RH-053-01	13 cm (5"), 35 mm, Fig. 1
RH-053-02	13 cm (5"), 50 mm, Fig. 2
RH-053-03	13 cm (5"), 75 mm, Fig. 3
RH-053-04	13 cm (5"), 85 mm, Fig. 4

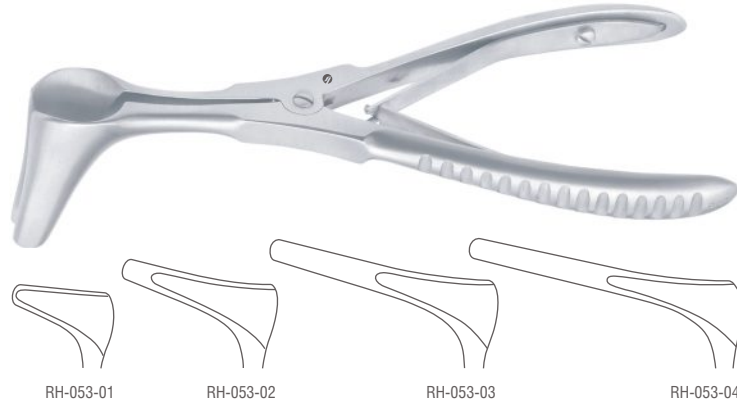

**Cottle Nasal Specula**

Set of 4 Ref; RH-063-01 to RH-063-04

Catalog #	Size
RH-061-10	Standard



**Cottle Nasal Speculum**

Catalog #	Size, Blade Length, Profile
RH-063-01	13.5 cm (5 1/4"), 35 mm, Fig. 1
RH-063-02	13.5 cm (5 1/4"), 50 mm, Fig. 2
RH-063-03	13.5 cm (5 1/4"), 75 mm, Fig. 3
RH-063-04	14.5 cm (5 3/4"), 85 mm, Fig. 4

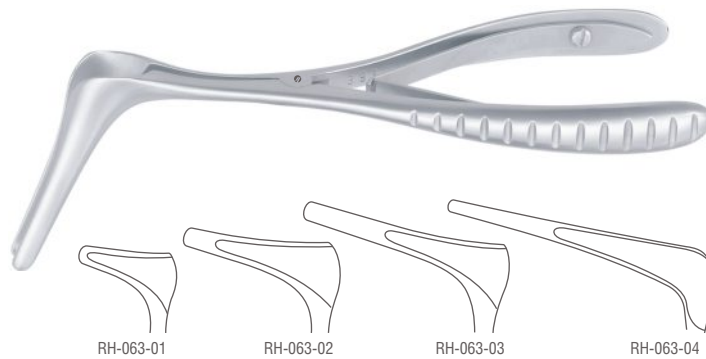

**Cottle Nasal Specula**

Set of 4 Ref; RH-067-01 to RH-067-04

Catalog #	Size
RH-065-10	Standard





Nasal Specula, Polypus Snares  
 Nasenspekula, Polypenschnürer  
 Espéculos nasales, Polipótomos  
 Spéculum nasaux, Serre-noeuds pour polypes  
 Specoli nasali, Serranodi per polipi

**Cottle Nasal Speculum**  
 With Screw Fixation



Catalog #	Size, Blade Length, Profile
RH-067-01	13.5 cm (5 1/4"), 35 mm, Fig. 1
RH-067-02	13.5 cm (5 1/4"), 50 mm, Fig. 2
RH-067-03	13.5 cm (5 1/4"), 75 mm, Fig. 3
RH-067-04	14.5 cm (5 3/4"), 85 mm, Fig. 4

**Cottle Nasal Specula**  
 Black



Catalog #	Size, Blade Length
RH-073-45	13.5 cm (5 1/4"), 45 mm
RH-073-75	14 cm (5 1/2"), 75 mm

**Krause Polypus Snare**



Catalog #	Size, Shaft Diameter
RH-091-26	26 cm (10 1/4"), Ø 3.0 mm

**Krause-Voss Polypus Snare**



Catalog #	Size, Shaft Diameter
RH-093-26	26 cm (10 1/4"), Ø 3.0 mm

**Lange-Wilde Polypus Snare**



Catalog #	Size
RH-095-24	24 cm (9 1/2")



Nasal Tampon Forceps  
Nasentamponpinzetten  
Pinzas para taponamiento  
Pincés à pansements  
Pinze per medicature

**Polypus Wire**  
Bundle with 12 Pieces

Catalog #	Size, Diameter
RH-097-12	10.5 cm (4"), Ø 0.3



**Troeltsch Nasal Tampon Forcep**

Catalog #	Size
RH-101-15	14.5 cm (5 3/4")



**Troeltsch Nasal Tampon Forcep**

Catalog #	Size
RH-103-18	18 cm (7")



**Gruenwald (Jansen) Nasal Tampon Forcep**

Catalog #	Size
RH-105-21	21.5 cm (8 1/2")



**Nasal Tampon Forcep**  
Smooth Jaws

Catalog #	Size
RH-107-16	16 cm (6 1/4")





Nasal Tampon Forceps  
Nasentamponpinzetten  
Pinzas para taponamiento  
Pincas à pansements  
Pinze per medicature

**Nasal Tampon Forcep**  
1 x 2 Teeth

Catalog #	Size
RH-109-16	16 cm (6 1/4")



**Nasal Tampon Forcep**  
Smooth Jaws

Catalog #	Size
RH-111-18	18.5 cm (7 1/4")



**Nasal Tampon Forcep**  
1 x 2 Teeth

Catalog #	Size
RH-113-20	20 cm (8")



**Westmacott Nasal Polypus Forcep**

Catalog #	Size
RH-121-18	18.5 cm (7 1/4")

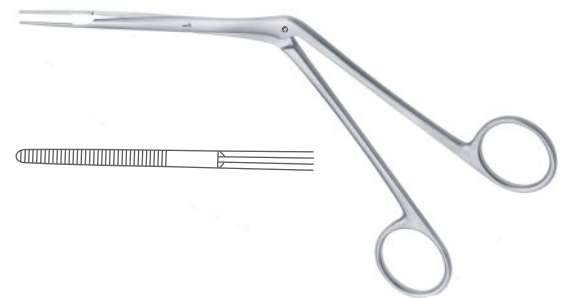

**Lubet-Barbon Nasal Polypus Forcep**

Catalog #	Size
RH-123-20	20 cm (8")





Nasal Tampon Forceps  
Nasentamponpinzetten  
Pinzas para taponamiento  
Pincès à pansements  
Pinze per medicature

**Hartmann Nasal Polypus Forcep**



Catalog #	Size
RH-127-16	15 cm (6")

**Heymann-Knight Nasal Polypus Forcep**



Catalog #	Size
RH-129-18	18 cm (7")

**Hartmann Nasal Polypus Forcep**



Catalog #	Size
RH-131-20	18.5 cm (7 1/4")

**Littauer Nasal Polypus Forcep**



Catalog #	Size
RH-133-18	18 cm (7")

**Killian Nasal Polypus Forcep**



Catalog #	Size
RH-135-16	16 cm (6 1/4")



Septum Forceps, Ethmoid Bone Forceps  
Septumzangen, Siebbeinzangen  
Pinzas para tabique nasal, Pinzas para etmoides  
Pinces pour la cloison nasale, Pinces éthmoidales  
Pinze per il setto nasale, Pinze etmoidali

**Heymann Septum Forcep**



Catalog #	Size, Profile
RH-161-01	18 cm (7"), Fig. 1
RH-161-02	18 cm (7"), Fig. 2
RH-161-03	18 cm (7"), Fig. 3

**Knight Septum Forcep**



Catalog #	Size
RH-165-17	17 cm (6 3/4")

**Craig Septum Forcep**



Catalog #	Size
RH-167-16	16 cm (6 1/4")

**Craig-Dominick Ethmoid Forcep**

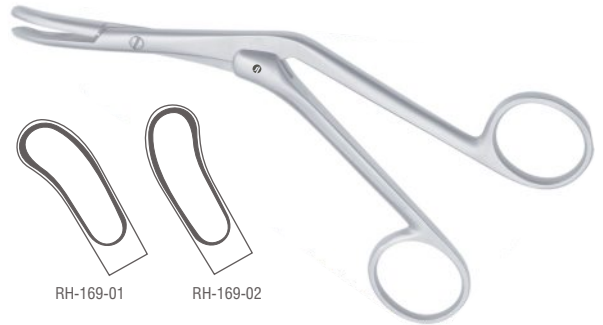

Catalog #	Size, Profile
RH-169-01	16 cm (6 1/4"), Curved Left
RH-169-02	16 cm (6 1/4"), Curved Right

RH-169-01

RH-169-02

**Luc Ethmoid Forcep**  
Fenestrated

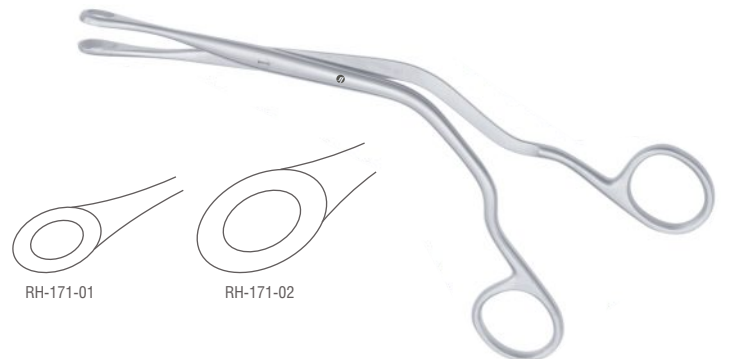

Catalog #	Size, Profile
RH-171-01	20 cm (8"), Fig. 1
RH-171-02	20 cm (8"), Fig. 2

RH-171-01

RH-171-02

INCHES  
MILLIMETERS



Ethmoid Bone Forceps  
Siebbeinzangen  
Pinzas para etmoides  
Pinces éthmoidales  
Pinze etmoidali

**Luc Ethmoid Forcep**



Catalog #	Size, Profile
RH-173-01	20 cm (8"), Fig. 1
RH-173-02	20 cm (8"), Fig. 2

**Bruenings Ethmoid Forcep**



Catalog #	Size, Profile
RH-175-01	16.5 cm (6 1/2"), Fig. 1
RH-175-02	16.5 cm (6 1/2"), Fig. 2
RH-175-03	16.5 cm (6 1/2"), Fig. 3
RH-175-04	16.5 cm (6 1/2"), Fig. 4

**Takahashi Ethmoid Forcep  
Straight**



Catalog #	Size
RH-181-12	12 cm (4 3/4")

**Takahashi Ethmoid Forcep  
Bent Upwards**



Catalog #	Size
RH-183-12	12 cm (4 3/4")

**Watson-Williams Ethmoid Forcep**



Catalog #	Size
RH-191-19	12 cm (4 3/4")



Nasal Cutting Forceps, Ethmoid Bone Forceps  
Scharfe Nasenzangen, Siebbeinzangen  
Pinzas nasales cortantes, Pinzas para etmoides  
Pinces nasales coupantes, Pinces éthmoïdales  
Pinze taglianti per il naso, Pinze etmoidali

**Watson-Williams Ethmoid Forcep**



Catalog #	Size
RH-193-19	12 cm (4 3/4")

**Weil Ethmoid Forcep  
With Neck**

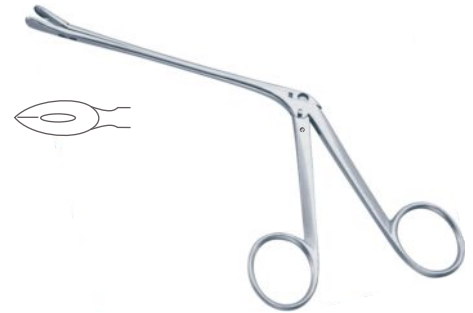

Catalog #	Size
RH-195-19	12 cm (4 3/4")

**Weil-Blakesley Nasal Cutting Forcep  
Straight**



Catalog #	Size, Bite Size, Profile
RH-201-01	12 cm (4 3/4"), 3.0 mm, Fig. 1
RH-201-02	12 cm (4 3/4"), 3.5 mm, Fig. 2
RH-201-03	12 cm (4 3/4"), 4.5 mm, Fig. 3
RH-201-04	12 cm (4 3/4"), 5.0 mm, Fig. 4
RH-201-05	12 cm (4 3/4"), 5.5 mm, Fig. 5

**Weil-Blakesley Nasal Cutting Forcep  
Angled 45°**



Catalog #	Size, Bite Size, Profile
RH-203-01	12 cm (4 3/4"), 3.0 mm, Fig. 1
RH-203-02	12 cm (4 3/4"), 3.5 mm, Fig. 2
RH-203-03	12 cm (4 3/4"), 4.5 mm, Fig. 3
RH-203-04	12 cm (4 3/4"), 5.0 mm, Fig. 4





Nasal Cutting Forceps, Ethmoid Bone Forceps  
Scharfe Nasenzangen, Siebbeinzangen  
Pinzas nasales cortantes, Pinzas para etmoides  
Pincas nasales coupantes, Pincas éthmoidales  
Pinze taglianti per il naso, Pinze etmoidali

**Weil-Blakesley Nasal Cutting Forcep**  
Angled 90°

Catalog #	Size, Bite Size, Profile
RH-205-01	12 cm (4 3/4"), 3.0 mm, Fig. 1
RH-205-02	12 cm (4 3/4"), 3.0 mm??, Fig. 2
RH-205-03	12 cm (4 3/4"), 4.5 mm, Fig. 3
RH-205-04	12 cm (4 3/4"), 5.0 mm, Fig. 4



**Struycken Nasal Cutting Forcep**

Catalog #	Size, Bite Size, Profile
RH-231-01	12 cm (4 3/4"), 0.9 mm, Fig. 1
RH-231-02	12 cm (4 3/4"), 1.2 mm, Fig. 2



**Stamberger Nasal Cutting Forcep**

Catalog #	Size, Bite Size, Profile
RH-235-01	12 cm (4 3/4"), 2.0 mm, Retrograde Up Cutting
RH-235-02	12 cm (4 3/4"), 2.0 mm, Retrograde Right Cutting
RH-235-03	12 cm (4 3/4"), 2.0 mm, Retrograde Left Cutting



**Hartmann Nasal Cutting Forcep (Conchotome)**

Catalog #	Size, Diameter, Profile
RH-241-01	12 cm (4 3/4"), Ø 5.0 mm, Fig. 1
RH-241-02	12 cm (4 3/4"), Ø 7.0 mm, Fig. 2
RH-241-03	12 cm (4 3/4"), Ø 9.0 mm, Fig. 3
RH-241-04	12 cm (4 3/4"), Ø 11.0 mm, Fig. 4





Septum Forceps, Septum Morselizer  
 Septumzangen, Septumquetschzange  
 Pinzas para tabique nasal, Pinza para aplastamiento  
 Pincas pour la cloison nasale, Pince-gouge pour la cloison nasale  
 Pinze per il setto nasale, Pinza contundente per il setto nasale

**Schmeden Nasal Cutting Forcep**



Catalog #	Size, Diameter
RH-245-12	12 cm (4 3/4"), Ø 8.0 mm

**Jansen-Middelton Septum Forcep  
 Through Cutting Jaws**

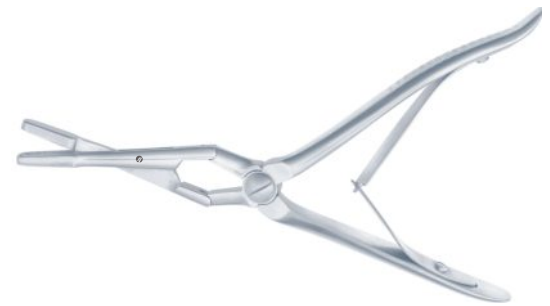

Catalog #	Size
RH-281-19	19 cm (7 1/2")

**Jansen-Middelton Septum Forcep  
 Curved Shaped Jaws**



Catalog #	Size
RH-283-19	19 cm (7 1/2")

**UltraGrip™ TC Rubin Septum Forcep**

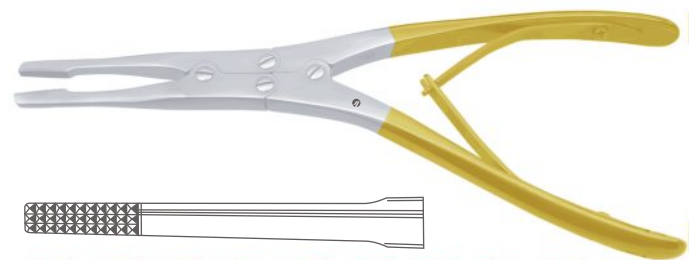

Catalog #	Size
RH-291-21	21 cm (8 1/4")



**UltraGrip™ TC Lower Lateral Morselizer**



Catalog #	Size
RH-293-21	19 cm (7 1/2")

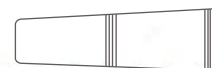



Sphenoid Bone Punches  
Keilbeinstanzen  
Pinzas sacabocadas para esfenoides  
Pinces emporte-pièces pour sinus sphénoïdal  
Pinze taglianti per seno sfenoidale

**Hajek Sphenoid Punch**

Catalog #	Size, Bite Size, Profile
RH-301-01	14 cm (5 1/2"), 4.0 mm x 4.0 mm, Up Cutting
RH-301-02	14 cm (5 1/2"), 4.0 mm x 4.0 mm, Down Cutting

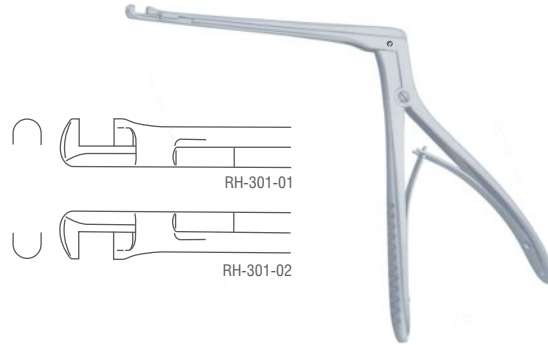

**Hajek-Kofler Sphenoid Punch**

Catalog #	Size, Bite Size, Profile
RH-303-01	14 cm (5 1/2"), 3.5 mm x 3.5 mm, Up Cutting
RH-303-02	14 cm (5 1/2"), 3.5 mm x 3.5 mm, Down Cutting

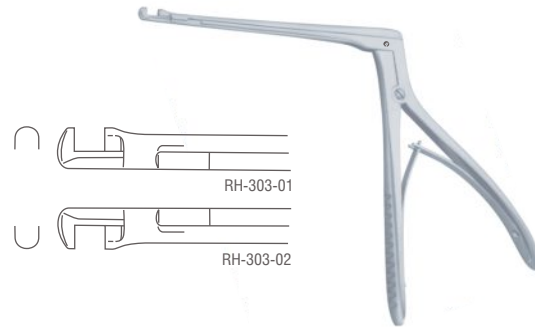

**Kerrison Sphenoid Punch**  
Up Cutting

Catalog #	Size, Diameter
RH-305-03	14 cm (5 1/2"), Ø 3.0 mm x 3.0 mm
RH-305-04	9 cm (3 1/2"), Ø 4.0 mm x 4.0 mm
RH-305-05	9 cm (3 1/2"), Ø 5.0 mm x 5.0 mm
RH-305-06	9 cm (3 1/2"), Ø 6.0 mm x 6.0 mm



**Joseph Rhinoplasty Knife**  
Straight, Fig. 1

Catalog #	Size
RH-350-15	15 cm (6")

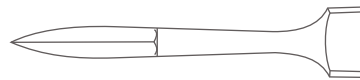

**Joseph Rhinoplasty Knife**  
Curved, Fig. 2

Catalog #	Size
RH-351-15	15 cm (6")

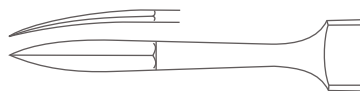



Rhinoplastic Knives  
Rhinoplastik-Messer  
Cuchillos rinoplásticos  
Couteaux pour plastie du nez  
Bisturi per plastica nasale

**Fomon Rhinoplasty Knife**

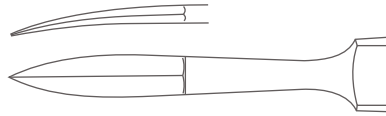

Catalog #	Size
RH-355-15	16.5 cm (6 1/2")

**Converse Rhinoplasty Knife**



Catalog #	Size
RH-361-16	16 cm (6 1/4")

**Joseph Rhinoplasty Knife**



Catalog #	Size
RH-365-15	15 cm (6")

**Cottle Rhinoplasty Knife**



Catalog #	Size
RH-367-15	14 cm (5 1/2")

**Freer Mucosa Knife**



Catalog #	Size
RH-369-15	16.5 cm (6 1/2")



Septum Knives, Swivel Knives  
Septummesser, Schwingmesser  
Cuchillos para tabique nasal  
Bistouris pour la cloison nasale  
Bisturi per il setto nasale

**Freer Septum Knife**



Catalog #	Size, Profile
RH-371-01	18 cm (7"), Right
RH-371-02	18 cm (7"), Left

**Freer Septum Knife**



Catalog #	Size
RH-373-01	18 cm (7")
RH-373-02	19 cm (7 1/2")

**Ballenger Swivel Knife**  
Straight

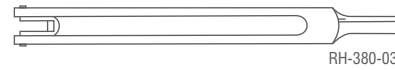

Catalog #	Size, Cutting Edge Size
RH-380-03	21 cm (8 1/4"), 3.0 mm
RH-380-04	21 cm (8 1/4"), 4.0 mm
RH-380-05	21 cm (8 1/4"), 5.0 mm

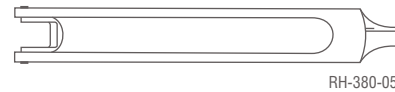
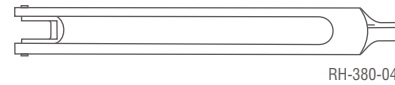

**Ballenger Swivel Knife**  
Bayonet Shaped

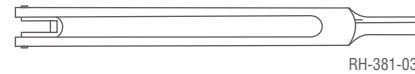

Catalog #	Size, Cutting Edge Size
RH-381-03	20 cm (8"), 3.0 mm
RH-381-04	20 cm (8"), 4.0 mm
RH-381-05	20 cm (8"), 5.0 mm

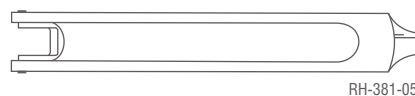
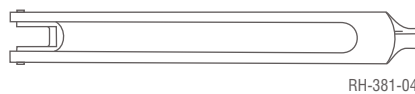



Septum Elevators  
Septumelevatorien  
Elevadores para tabique nasal  
Elévateurs pour la cloison nasale  
Elevatori per il setto nasale

**McKenty Septum Elevator**



Catalog #	Size, Blade Size
RH-451-04	15 cm (6"), 4.0 mm
RH-451-05	15 cm (6"), 5.0 mm



**Halle Septum Elevator**



Catalog #	Size, Blade Size
RH-455-16	16 cm (6 1/4"), 3.5 mm



**Joseph Septum Elevator**



Catalog #	Size, Blade Size
RH-461-16	16 cm (6 1/4"), 4.0 mm



**Freer Septum Elevator**



Catalog #	Size, Blade Size, Profile
RH-471-19	19 cm (7 1/2"), 5.0 mm, Sharp
RH-473-19	19 cm (7 1/2"), 6.0 mm, Blunt

**Freer Septum Elevator**  
Double Ended, Sharp/Blunt



Catalog #	Size, Blade Size 1, Blade Size 2
RH-475-18	18.5 cm (7 1/4"), 5.0 mm, 5.0 mm





Septum Elevators  
Septumelevatorien  
Elevadores para tabique nasal  
Élévateurs pour la cloison nasale  
Elevatori per il setto nasale

**Freer Septum Elevator**

Double Ended, Sharp/Blunt

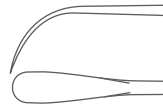

Catalog #            Size, Blade Size 1, Blade Size 2  
RH-477-20            20.5 cm (8"), 6.0 mm, 5.0 mm

**McKenty Septum Elevator**



Catalog #            Size, Blade Size 1, Blade Size 2  
RH-479-20            20.5 cm (8"), 4.0 mm, 4.0 mm

**Ballenger-Hajek Septum Elevator**



Catalog #            Size, Blade Size 1, Blade Size 2  
RH-482-19            19 cm (7 1/2"), 6.0 mm, 6.0 mm

**Cottle Septum Elevator**

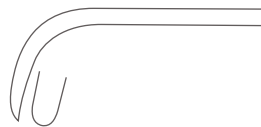

Catalog #            Size, Blade Size 1, Blade Size 2  
RH-501-23            23.5 cm (9 1/4"), 5.0 mm, 5.0 mm

**Killian Septum Elevator**

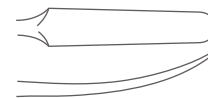

Catalog #            Size, Blade Size 1, Blade Size 2  
RH-503-18            18 cm (7"), 4.0 mm, 4.0 mm



Periosteal Elevators  
Periostelevatorien  
Legras para periostio  
Élévateurs pour le périoste  
Elevatori per il periosto

**Killian Septum Elevator**



Catalog #	Size, Blade Size 1, Blade Size 2
RH-505-23	23 cm (9"), 4.5 mm , 4.5 mm

**Pierce Septum Elevator**

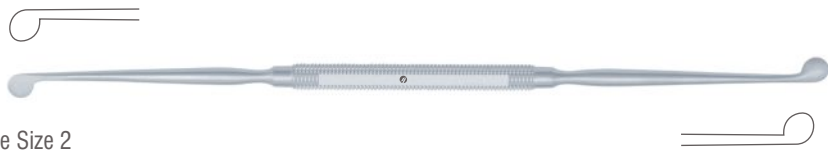

Catalog #	Size, Blade Size 1, Blade Size 2
RH-507-21	21.5 cm (8 1/2"), 4.0 mm , 4.0 mm

**Pennington Septum Elevator**



Catalog #	Size, Blade Size 1, Blade Size 2
RH-509-21	21.5 cm (8 1/2"), 4.0 mm , 4.0 mm

**Roger Periosteal Elevator**



Catalog #	Size, Blade Size 1, Blade Size 2
RH-511-19	19.5 cm (7 3/4"), 4.0 mm , 4.0 mm

**Cottle Periosteal Elevator**



Catalog #	Size, Blade Size 1, Blade Size 2
RH-541-22	23 cm (9"), 3.3 mm , 3.7 mm





Periosteal Elevators  
Periostelevatorien  
Legras para periostio  
Élévateurs pour le périoste  
Elevatori per il periosto

**Masing Periosteal Elevator**



Catalog #                      Size, Blade Size 1, Blade Size 2  
RH-543-21                      19.5 cm (7 3/4"), 3.0 mm , 2.0 mm

**Cottle Periosteal Elevator**

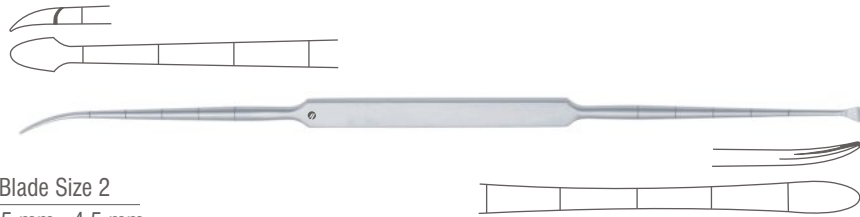

Catalog #                      Size, Blade Size 1, Blade Size 2  
RH-545-21                      19.5 cm (7 3/4"), 4.5 mm , 4.5 mm

**Howarth Periosteal Elevator**



Catalog #                      Size  
RH-547-21                      21.5 cm (8 1/2")

**Joseph Periosteal Elevator**



Catalog #                      Size, Blade Width  
RH-551-16                      18 cm (7"), 6.0 mm

**Freer Septum Chisel**  
Straight



Catalog #                      Size, Blade Width  
RH-600-16                      16.5 cm (6 1/2"), 4.0 mm



Septum Chisels, Septum Gouges  
 Septummeißel, Septum-Hohlmeißel  
 Cinceles para tabique nasal, Gubias para tabique nasal  
 Élévateurs pour le périoste, Gouges pour la cloison nasale  
 Elevatori per il periosto, Sgorbie per il setto nasale

**Freer Septum Chisel**  
 Curved

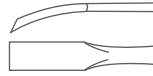

Catalog #	Size, Blade Width
RH-601-16	16.5 cm (6 1/2"), 4.0 mm

**West Septum Chisel**



Catalog #	Size
RH-604-16	16 cm (6 1/4")

**West Septum Gouge**



Catalog #	Size
RH-605-16	16 cm (6 1/4")

**Freer Septum Gouge**

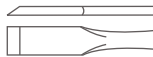

Catalog #	Size, Blade Width
RH-608-16	15 cm (6"), 6.0 mm

**Ballenger Septum Gouge**

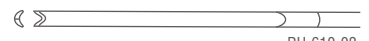

RH-610-02



RH-610-04



RH-610-06



RH-610-08

Catalog #	Size, Blade Width
RH-610-02	15 cm (6"), 2.0 mm
RH-610-04	15 cm (6"), 4.0 mm
RH-610-06	15 cm (6"), 6.0 mm
RH-610-08	15 cm (6"), 8.0 mm





Septum Chisels, Septum Gouges  
Septummeißel, Septum-Hohlmeißel  
Cinceles para tabique nasal, Gubias para tabique nasal  
Élévateurs pour le périoste, Gouges pour la cloison nasale  
Elevatori per il periosto, Sgorbie per il setto nasale

**Killian Septum Gouge**  
Bayonet Shaped

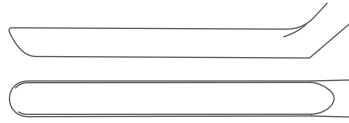

Catalog #	Size, Blade Width
RH-613-16	16 cm (6 1/4"), 8.0 mm



**Killian-Claus Septum Gouge**  
Bayonet Shaped

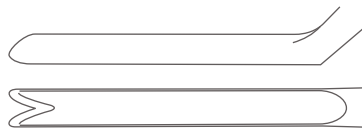

Catalog #	Size, Blade Width
RH-615-16	16 cm (6 1/4"), 5.0 mm



**Cottle Osteotome**  
Straight



Catalog #	Size, Blade Width
RH-620-02	18.5 cm (7 1/4"), 2.0 mm
RH-620-04	18.5 cm (7 1/4"), 4.0 mm
RH-620-07	18.5 cm (7 1/4"), 7.0 mm
RH-620-09	18.5 cm (7 1/4"), 9.0 mm
RH-620-12	18.5 cm (7 1/4"), 12.0 mm



**Cottle Osteotome**  
Curved



Catalog #	Size, Blade Width
RH-621-02	18.5 cm (7 1/4"), 2.0 mm
RH-621-04	18.5 cm (7 1/4"), 4.0 mm
RH-621-06	18.5 cm (7 1/4"), 6.0 mm
RH-621-09	18.5 cm (7 1/4"), 9.0 mm
RH-621-12	18.5 cm (7 1/4"), 12.0 mm





Osteotomes, Chisels  
Osteotome, Meißel  
Osteótomos, Cinceles  
Ostéotomes, Ciseaux-burins  
Osteotomi, Scalpelli

**Cottle Chisel**  
Straight, Cross Handle

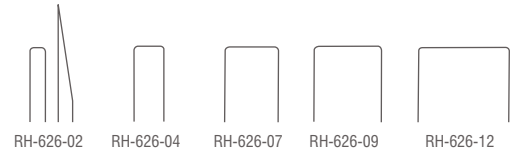

Catalog #	Size, Blade Width
RH-626-02	18.5 cm (7 1/4"), 2.0 mm
RH-626-04	18.5 cm (7 1/4"), 4.0 mm
RH-626-07	18.5 cm (7 1/4"), 7.0 mm
RH-626-09	18.5 cm (7 1/4"), 9.0 mm
RH-626-12	18.5 cm (7 1/4"), 12.0 mm



**Cottle Chisel**  
Curved, Cross Handle

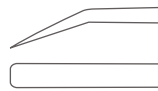

Catalog #	Size, Blade Width
RH-627-06	18.5 cm (7 1/4"), 6.0 mm



**Cottle Osteotome**

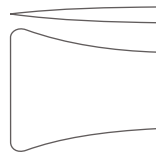

Catalog #	Size, Blade Width
RH-630-16	18.5 cm (7 1/4"), 16.0 mm



**Cottle Osteotome**  
Cross Handle

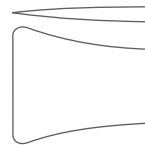

Catalog #	Size, Blade Width
RH-632-16	18.5 cm (7 1/4"), 16.0 mm





Osteotomes, Chisels  
Osteotome, Meißel  
Osteótomos, Cinceles  
Ostéotomes, Ciseaux-burins  
Osteotomi, Scalpelli

**Rubin Osteotome**

Catalog #	Size, Blade Width
RH-636-10	18.5 cm (7 1/4"), 10.0 mm
RH-636-12	18.5 cm (7 1/4"), 12.0 mm
RH-636-14	18.5 cm (7 1/4"), 14.0 mm

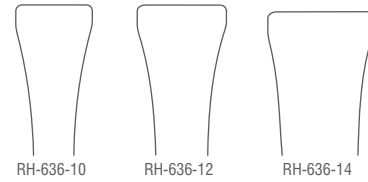

**Walter Chisel**

Catalog #	Size, Blade Width
RH-640-03	9 cm (7 1/2"), 3.0 mm
RH-640-04	9 cm (7 1/2"), 4.5 mm



**Walter Osteotome**

Catalog #	Size, Blade Width
RH-642-03	19 cm (7 1/2"), 3.0 mm
RH-642-04	19 cm (7 1/2"), 4.0 mm
RH-642-07	19 cm (7 1/2"), 7.0 mm
RH-642-09?	19 cm (7 1/2"), 9.0 mm
RH-642-12	19 cm (7 1/2"), 12.0 mm

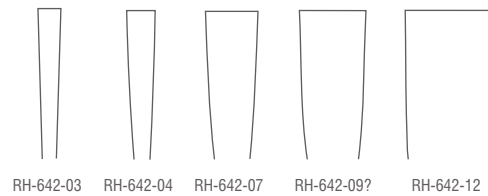

**Fomon Chisel**

Catalog #	Size, Blade Width
RH-648-04	16 cm (6 1/4"), 4.0 mm
RH-648-05	16 cm (6 1/4"), 5.0 mm
RH-648-06	16 cm (6 1/4"), 6.0 mm
RH-648-07?	16 cm (6 1/4"), 7.0 mm

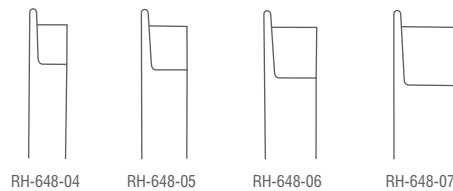



Rhinoplastic Chisels, Chisels  
Nasenmeißel, Meißel  
Cinceles nasales, Cinceles  
Ciseaux-burins nasaux, Ciseaux-burins  
Scalpelli nasali, Scalpelli

**Cinelli Osteotome**

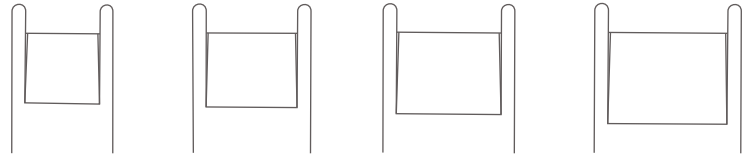

RH-650-10

RH-650-12

RH-650-14

RH-650-16

Catalog #	Size, Blade Width
RH-650-10	16 cm (6 1/4"), 10.0 mm
RH-650-12	16 cm (6 1/4"), 12.0 mm
RH-650-14	16 cm (6 1/4"), 14.0 mm
RH-650-16	16 cm (6 1/4"), 16.0 mm



**Neivert-Anderson Osteotome**

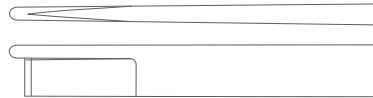

Catalog #	Size, Blade Width
RH-654-07	20.5 cm (8"), 7.0 mm



**Neivert-Anderson Osteotome  
Left**

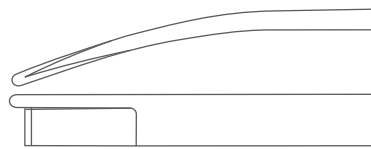

Catalog #	Size, Blade Width
RH-655-07	20.5 cm (8"), 7.0 mm



**Neivert-Anderson Osteotome  
Right**

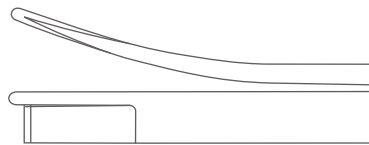

Catalog #	Size, Blade Width
RH-657-07	20.5 cm (8"), 7.0 mm





Rhinoplastic Chisels, Chisels  
Nasenmeißel, Meißel  
Cinceles nasales, Cinceles  
Ciseaux-burins nasaux, Ciseaux-burins  
Scalpelli nasali, Scalpelli

**Cottle Chisel**



Catalog #	Size, Blade Width
RH-660-04	18 cm (7"), 4.0 mm
RH-660-07	18 cm (7"), 7.0 mm
RH-660-09	18 cm (7"), 9.0 mm
RH-660-12	18 cm (7"), 12.0 mm



**Sheehan Osteotome**

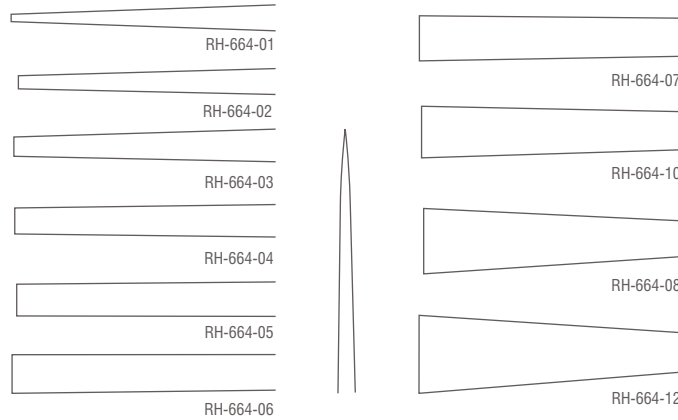

Catalog #	Size, Blade Width
RH-664-01	15 cm (6"), 1.0 mm
RH-664-02	15 cm (6"), 2.0 mm
RH-664-03	15 cm (6"), 3.0 mm
RH-664-04	15 cm (6"), 4.0 mm
RH-664-05	15 cm (6"), 5.0 mm
RH-664-06	15 cm (6"), 6.0 mm
RH-664-07	15 cm (6"), 7.0 mm
RH-664-08	15 cm (6"), 8.0 mm
RH-664-10	15 cm (6"), 10.0 mm
RH-664-12	15 cm (6"), 12.0 mm



**Silver Chisel**  
Straight



Catalog #	Size, Blade Width
RH-666-05	18 cm (7"), 5.0 mm



**Silver Chisel**  
Right

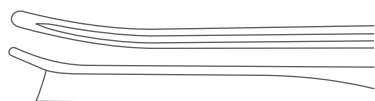

Catalog #	Size, Blade Width
RH-667-05	18 cm (7"), 5.0 mm





Rhinoplastic Chisels, Chisels, Nasal Saws  
 Nasenmeißel, Meißel, Nasensägen  
 Cinceles nasales, Cinceles, Sierras nasales  
 Ciseaux-burins nasaux, Ciseaux-burins, Scies nasales  
 Scalpelli nasali, Scalpelli, Seghe nasali

**Silver Chisel**  
Left Curved

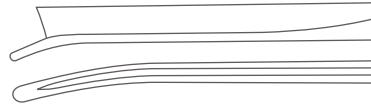

Catalog #	Size, Blade Width
RH-669-05	18 cm (7"), 5.0 mm

**Parkes Osteotome**

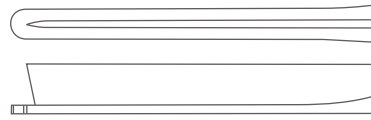

Catalog #	Size
RH-672-01	16 cm (6 1/4")

**Joseph Nasal Saw**

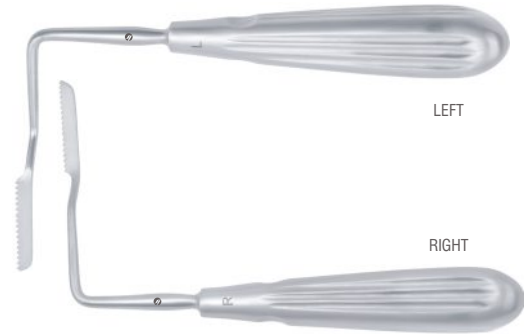

Catalog #	Size, Profile
RH-691-01?	17 cm (6 3/4"), Angled to Left
RH-691-02	17 cm (6 3/4"), Angled to Right

**Joseph Nasal Saw**  
Straight



Catalog #	Size, Working Length
RH-692-19	19 cm (7 1/2"), 40.0 mm

**Joseph Nasal Saw**  
Bayonet Shaped



Catalog #	Size, Working Length
RH-693-01	19 cm (7 1/2"), 40.0 mm
RH-693-02	19 cm (7 1/2"), 40.0 mm

RH-693-01

RH-693-02





Cartilage Crusher, Nasal Rasps, Bone Files, Antrum Rasps  
Knorpelquetsche, Nasenraspeln, Knochenfeilen, Antrumraspeln  
Machacadora, Escofinas nasales, Limas para huesos, Escofinas para el antro  
Pincers-gouge à cartilage, Râpes nasales, Limes à os, Râpes pour antre  
Torchio per cartilagine, Raspe nasali, Lime per ossa, Raspe per seno mascellare

**Cottle Cartilage Crusher**



Catalog #	Size
RH-698-00	Standard

**Miller-Colburn Bone File**  
Drawing Cut

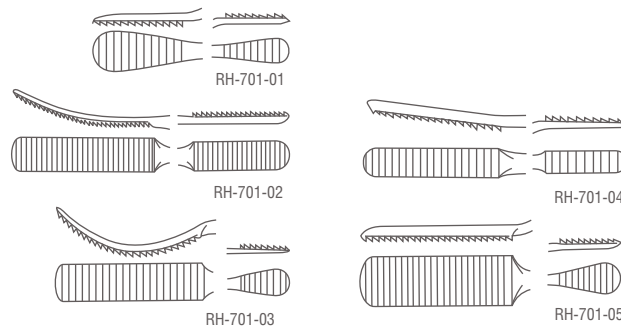

Catalog #	Size, Profile
RH-701-01	18 cm (7"), Fig. 1
RH-701-02	18 cm (7"), Fig. 2
RH-701-03	18 cm (7"), Fig. 3
RH-701-04	18 cm (7"), Fig. 4
RH-701-05	18 cm (7"), Fig. 5



**Miller-Colburn Bone File**  
Cross Cut

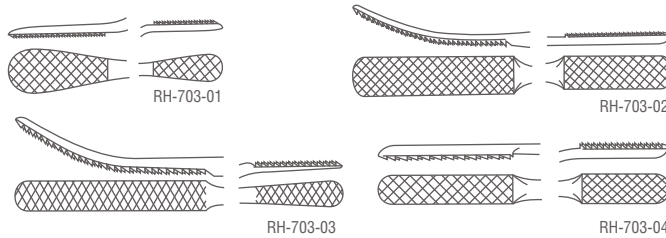

Catalog #	Size, Profile
RH-703-01	18 cm (7"), Fig. 1
RH-703-02	18 cm (7"), Fig. 2
RH-703-03	18 cm (7")?, Fig. 3
RH-703-04	18 cm (7"), Fig. 4



**UltraCut™ TC Miller Bone File**  
Drawing Cut

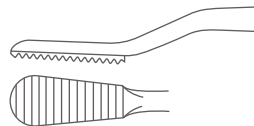

Catalog #	Size
RH-705-01	19 cm (7 1/2")





Nasal Rasps, Bone Files, Antrum Rasps  
 Nasenraspeln, Knochenfeilen, Antrumraspeln  
 Escofinas nasales, Limas para huesos, Escofinas para el antro  
 Râpes nasales, Limes à os, Râpes pour antre  
 Raspe nasali, Lime per ossa, Raspe per seno mascellare

**UltraCut™ TC Miller Bone File**  
 Cross Cut



Catalog #	Size
RH-707-01	19 cm (7 1/2")



**Maltz Nasal Rasp**  
 Drawing Cut

Catalog #	Size, Cutting Edge
RH-710-18	17.5 cm (7"), 40 x 9 mm

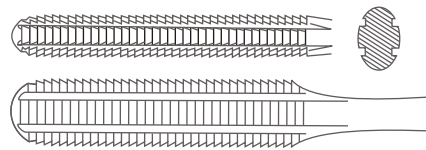

**Maltz Nasal Rasp**

Catalog #	Size, Cutting Edge, Profile
RH-712-01	17 cm (6 3/4"), 34 x 7 mm, Drawing Cut
RH-712-02	17 cm (6 3/4"), 34 x 7 mm, Pushing Cut

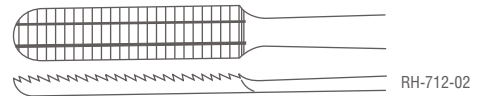
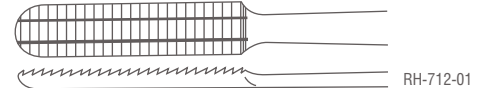

**Joseph Bone File**

Catalog #	Size, Cutting Edge
RH-714-01	16 cm (6 1/4"), 60 x 8 mm
RH-714-02	16 cm (6 1/4"), 45 x 9 mm

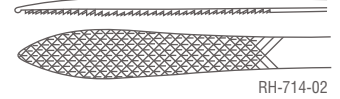
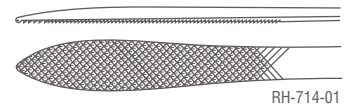

**Fomon Bone File**

Catalog #	Size, Cutting Edge, Profile
RH-720-01	21 cm (8 1/4"), 30 x 8 mm, Fine
RH-720-02	21 cm (8 1/4"), 30 x 8 mm, Coarse

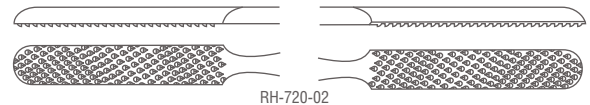
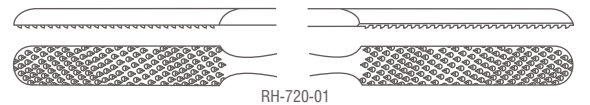



Nasal Rasps, Bone Files, Antrum Rasps  
Nasenraspeln, Knochenfeilen, Antrumraspeln  
Escofinas nasales, Limas para huesos, Escofinas para el antro  
Râpes nasales, Limes à os, Râpes pour antre  
Raspe nasali, Lime per ossa, Raspe per seno mascellare

**Parkes Bone File**  
Drawing Cut

Catalog #	Size, Cutting Edge
RH-722-01	19.5 cm (7 3/4"), 35 x 8 mm
RH-722-02	19.5 cm (7 3/4"), 35 x 10 mm

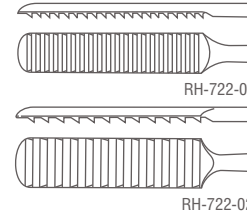

**Gallaher Antrum Rasp**

Catalog #	Size, Cutting Edge, Profile
RH-724-01	17 cm (6 3/4"), 45 x 6 mm, Straight
RH-724-02	17 cm (6 3/4"), 45 x 6 mm, Left
RH-724-03	17 cm (6 3/4"), 45 x 6 mm, Right



**Cottle Nasal Rasp**

Catalog #	Size, Cutting Edge
RH-726-21	20.5 cm (8"), 30 x 8 mm

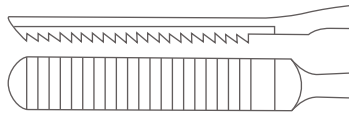
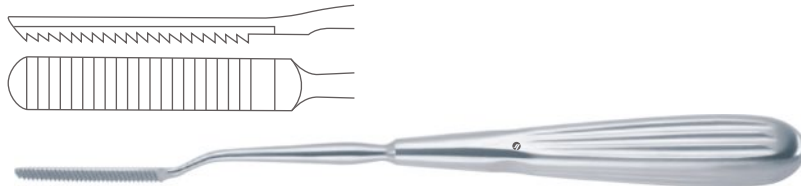

**Aufricht Glabella Rasp**

Catalog #	Size, Cutting Edge, Profile
RH-729-01	21 cm (8 1/4"), 32 x 9 mm, Pushing Cut
RH-729-02	21 cm (8 1/4"), 32 x 9 mm, Drawing Cut

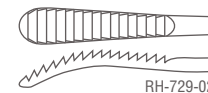
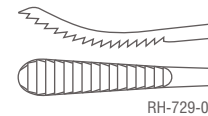

**Lewis Nasal Rasp**  
Drawing Cut

Catalog #	Size, Cutting Edge, Profile
RH-732-01	19 cm (7 1/2"), 15 x 8 mm, Fine
RH-732-02	19 cm (7 1/2"), 15 x 8 mm, Coarse

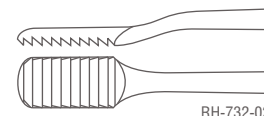
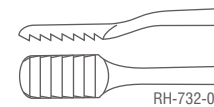



Nasal Rasps, Bone Files, Antrum Rasps  
 Nasenraspeln, Knochenfeilen, Antrumraspeln  
 Escofinas nasales, Limas para huesos, Escofinas para el antro  
 Râpes nasales, Limes à os, Râpes pour antre  
 Raspe nasali, Lime per ossa, Raspe per seno mascellare

**Wiener Nasal Rasp**

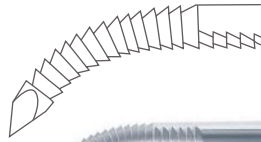

Catalog #	Size
RH-735-18	18 cm (7")

**Diam-n-Dust™ Bone File**  
Straight

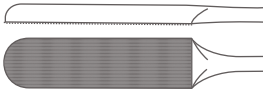

Catalog #	Size
RH-738-19	19 cm (7 1/2")



**Diam-n-Dust™ Bone File**  
Curved

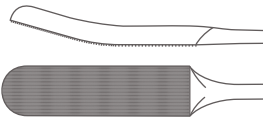

Catalog #	Size
RH-739-19	19 cm (7 1/2")



**UltraCut™ TC Maltz Nasal Rasp**



Catalog #	Size
RH-742-01	19.5 cm (7 3/4")
RH-742-02	19.5 cm (7 3/4")
RH-742-03	19.5 cm (7 3/4")
RH-742-04	19.5 cm (7 3/4")
RH-742-05	19.5 cm (7 3/4")
RH-742-06	19.5 cm (7 3/4")
RH-742-07	19.5 cm (7 3/4")
RH-742-08	19.5 cm (7 3/4")
RH-742-09	19.5 cm (7 3/4")
RH-742-10	19.5 cm (7 3/4")



RH-742-01

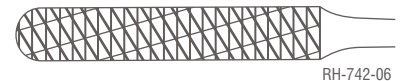

RH-742-06

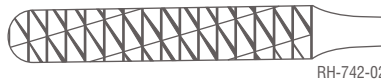

RH-742-02

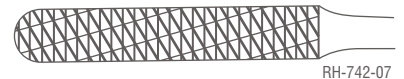

RH-742-07



RH-742-03

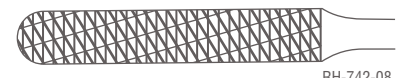

RH-742-08

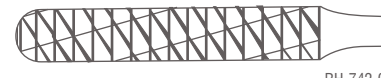

RH-742-04

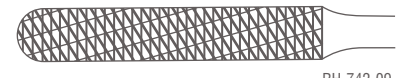

RH-742-09

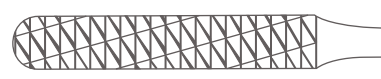

RH-742-05



RH-742-10



Nasal Rasps, Antrum Rasps  
Nasenraspeln, Antrumraspeln  
Escofinas nasales, Escofinas para el antro  
Râpes nasales, Râpes pour antre  
Raspe nasali, Raspe per seno mascellare

**Fomon Nasal Rasp**

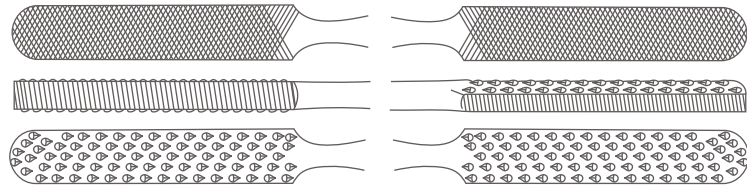

Catalog #                      Size, Cutting Edge  
RH-744-21                      20.5 cm (8"), 30 x 8 mm



**UltraCut™ Fomon Nasal Rasp**  
Fig. 1 -2

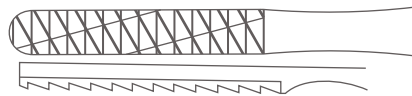

**ULTRACut™**

Catalog #                      Size, Cutting Edge  
RH-746-01                      20.5 cm (8"), 30 x 8 mm

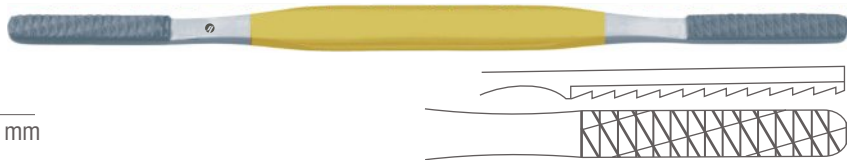

**UltraCut™ Fomon Nasal Rasp**  
Fig. 3 -4

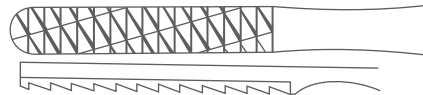

**ULTRACut™**

Catalog #                      Size, Cutting Edge  
RH-746-02                      20.5 cm (8"), 40 x 7 mm

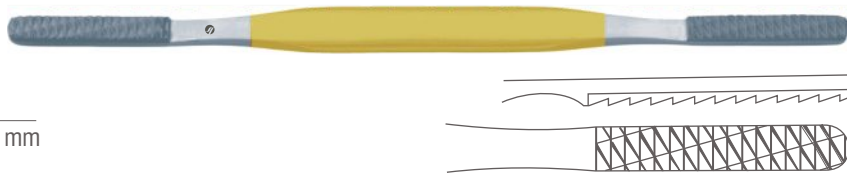

**UltraCut™ Fomon Nasal Rasp**  
Fig. 5 -6

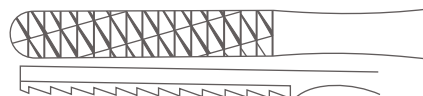

**ULTRACut™**

Catalog #                      Size, Cutting Edge  
RH-746-03                      20.5 cm (8"), 40 x 7 mm

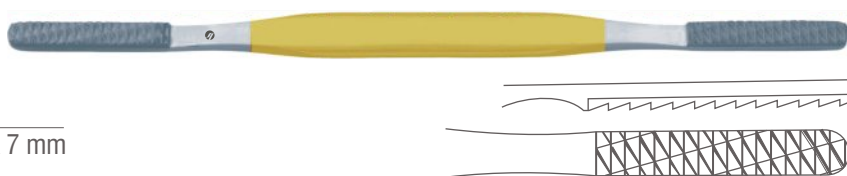

**UltraCut™ Fomon Nasal Rasp**  
Fig. 7 -8

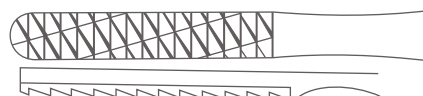

**ULTRACut™**

Catalog #                      Size, Cutting Edge  
RH-746-04                      20.5 cm (8"), 40 x 7 mm

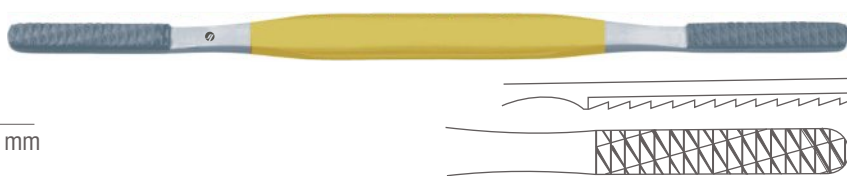



Alar Hooklets, Mucosa Hooklet  
 Nasenflügelhäkchen, Schleimhauthäkchen  
 Ganchitos para alas de nariz, Ganchito para mucosa  
 Crochets pour les ailes du nez, Crochet pour la muqueuse  
 Uncini per le pinne nasali, Uncino per mucosa

**UltraCut™ Fomon Nasal Rasp**  
 Fig. 9 -10

**ULTRACut™**

Catalog #	Size, Cutting Edge
RH-746-05	20.5 cm (8"), 40 x 7 mm

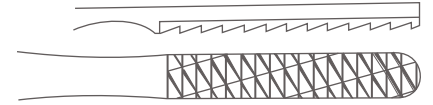
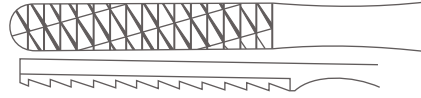

**Lange Alar Hook**  
 Button End

Catalog #	Size
RH-761-22	23 cm (9")



**Fomon Alar Hook**  
 Button End

Catalog #	Size
RH-763-17	17 cm (6 3/4")



**Fomon Alar Hook**  
 Button End

Catalog #	Size
RH-765-16	16 cm (6 1/4")

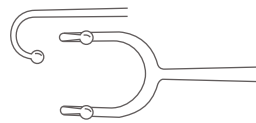

**Cottle-Neivert Alar Hook**

Catalog #	Size
RH-767-20	19.5 cm (7 3/4")

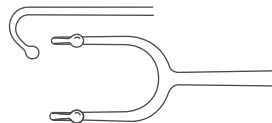



Alar Hooklets, Nasal Retractors  
Nasenflügelhäkchen, Nasenhaken  
Ganchitos para alas de nariz, Separadores nasales  
Crochets pour les ailes du nez, Ecarteurs nasaux  
Uncini per le pinne nasali, Divaricatori nasali

**Cottle Alar Hook**

Catalog #	Size
RH-771-01	14.5 cm (5 ¾"), Sharp
RH-771-02	14.5 cm (5 ¾"), Blunt, Sharp
RH-771-03	14.5 cm (5 ¾"), Sharp, Blunt

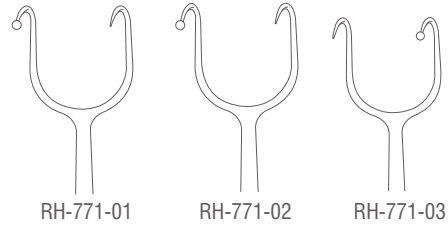

**Converse Nasal Retractor**

Catalog #	Size, Blade Size
RH-781-01	9 cm (3 ½"), 18 x 9.5 mm
RH-781-02	9 cm (3 ½"), 28 x 12.5 mm
RH-781-03	9 cm (3 ½"), 41 x 13.5 mm
RH-781-04	9 cm (3 ½"), 53 x 13.5 mm

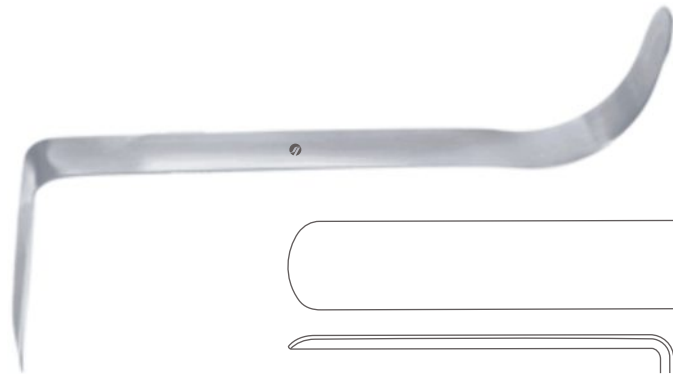

**Aufricht Nasal Retractor**

Catalog #	Size, Blade Size
RH-785-19	19 cm (7 ½"), 40 x 12 mm



**Converse Nasal Retractor**

Catalog #	Size, Blade Size
RH-787-11	10.5 cm (4"), 44 x 11 mm





Alar Hooklets, Nasal Retractors, Septum Forceps, Septum Straightening Forceps  
 Nasenflügelhäkchen, Nasenhaken, Septumzangen, Septumrichtzangen  
 Ganchitos para alas de nariz, Separadores nasales, Pinzas para tabique nasal, Pinzas para enderezar el tabique nasal  
 Crochets pour les ailes du nez, Ecarteurs nasaux, Pincés pour la cloison nasale, Pincés pour le redressement de la cloison nasale  
 Uncini per le pinne nasali, Divaricatori nasali, Pinze per il setto nasale, Pinze per raddizzare il setto nasale

**Neivert Nasal Retractor**



Catalog #	Size
RH-789-16	17 cm (6 3/4")

**Cottle Alar Retractor**



Catalog #	Size
RH-791-15	16 cm (6 1/4")

**Aufricht Nasal Retractor**  
Blunt



Catalog #	Size, Blade Size
RH-793-14	12 cm (4 3/4"), 60 x 6.5 mm

**Kressner Septum Forcep**



Catalog #	Size
RH-801-20	21 cm (8 1/4")

**Cottle-Walsham Septum Straightening Forcep**

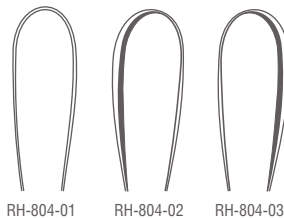

RH-804-01    RH-804-02    RH-804-03

Catalog #	Size, Profile
RH-804-01	23 cm (9"), Straight
RH-804-02	23 cm (9"), Left
RH-804-03	23 cm (9"), Right







Septum Forceps, Septum Straightening Forceps, Skin Grasping Forceps  
Septumzangen, Septumrichtzangen, Hautfasspinzetten  
Pinzas para tabique nasal, Pinzas para enderezar el tabique nasal, Pinzas para piel  
Pincas pour la cloison nasale, Pincas pour le redressement de la cloison nasale, Pincas pour saisir la peau  
Pinze per il setto nasale, Pinze per raddizzare il setto nasale, Pinze per afferrare la pelle

**Asch Septum Straightening Forcep**



Catalog #      Size  
RH-807-23      22.5 cm (8 3/4")

**Aiach Columella Suturing Forcep**



Catalog #      Size, Width  
RH-811-15      15.5 cm (6"), 5.0 mm

**Ogura Skin Grasping Forcep**



Catalog #      Size, Width  
RH-814-11      11 cm (4 1/4"), 4.0 mm

**Cottle Sking Grasping Forcep**



Catalog #      Size, Width  
RH-817-14      14 cm (5 1/2"), 1.7 mm

**Cottle Columella Forcep**



Catalog #      Size, Width  
RH-820-11      11 cm (4 1/4"), 12.0 mm

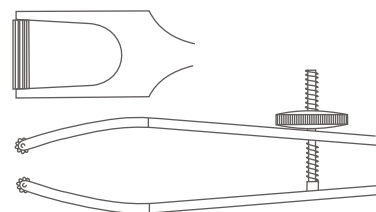



Antrum Curettes, Adenoid Curettes  
Antrumküretten, Ringmesser  
Curetas para el antro, Cuchillos para adenoides  
Curettes pour l'antre, Couteaux à végétations adénoïdales  
Curette per antro, Coltelli per vegetazioni adenoidee

**Faulkner Antrum Curette**



Catalog #	Size
RH-839-21	21 cm (8 1/4")

**Coakley Antrum Curette**

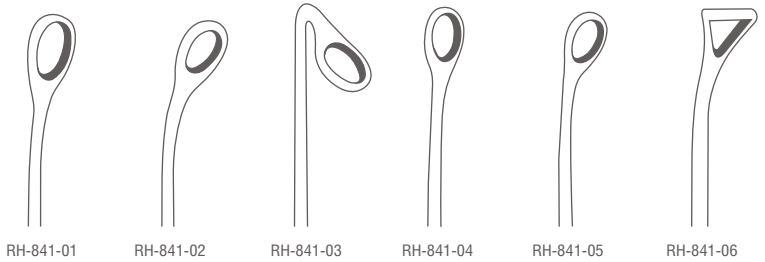

Catalog #	Size
RH-841-01	17 cm (6 3/4")
RH-841-02	17 cm (6 3/4")
RH-841-03	17 cm (6 3/4")
RH-841-04	17 cm (6 3/4")
RH-841-05	17 cm (6 3/4")
RH-841-06	17 cm (6 3/4")



**Beckmann Adenoid Curette**

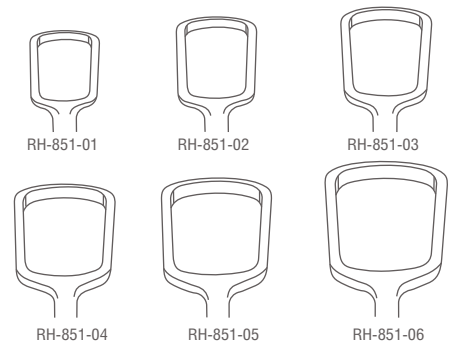

Catalog #	Size, Width, Profile
RH-851-01	22.5 cm (8 3/4"), 13.0 mm, Fig. 1
RH-851-02	22.5 cm (8 3/4"), 15.0 mm, Fig. 2
RH-851-03	22.5 cm (8 3/4"), 17.0 mm, Fig. 3
RH-851-04	22.5 cm (8 3/4"), 19.0 mm, Fig. 4
RH-851-05	22.5 cm (8 3/4"), 21.0 mm, Fig. 5
RH-851-06	22.5 cm (8 3/4"), 23.0 mm, Fig. 6



**Beckmann Adenoid Curette  
Angled Shaft**

Catalog #	Size, Width, Profile
RH-853-01	22 cm (8 3/4"), 13.0 mm, Fig. 1
RH-853-02	22 cm (8 3/4"), 15.0 mm, Fig. 2
RH-853-03	22 cm (8 3/4"), 17.0 mm, Fig. 3
RH-853-04	22 cm (8 3/4"), 19.0 mm, Fig. 4
RH-853-05	22 cm (8 3/4"), 21.0 mm, Fig. 5
RH-853-06	22 cm (8 3/4"), 23.0 mm, Fig. 6





Adenoid Curettes  
Ringmesser  
Cuchillos para adenoides  
Couteaux à végétations adénoïdales  
Coltelli per vegetazioni adenoidee

**Barnhill Adenoid Curette**



Catalog #	Size, Profile
RH-855-01	22 cm (8 3/4"), 11 mm, Fig. 1
RH-855-02	22 cm (8 3/4"), 13 mm, Fig. 2
RH-855-03	22 cm (8 3/4"), 15 mm, Fig. 3
RH-855-04	22 cm (8 3/4"), 17 mm, Fig. 4
RH-855-05	22 cm (8 3/4"), 19 mm, Fig. 5

**St. Clair Thompson Adenoid Curette**



Catalog #	Size, Profile
RH-857-01	21 cm (8 1/4"), 10 mm, Fig. 1
RH-857-02	21 cm (8 1/4"), 12 mm, Fig. 2
RH-857-03	21 cm (8 1/4"), 14 mm, Fig. 3
RH-857-04	21 cm (8 1/4"), 16 mm, Fig. 4

**LaForce Adenotome**  
With Non-Perforated Blade



Catalog #	Size, Profile
RH-861-01	25 cm (9 3/4"), Fig. 1
RH-861-02	25 cm (9 3/4"), Fig. 2
RH-861-03	25 cm (9 3/4"), Fig. 3

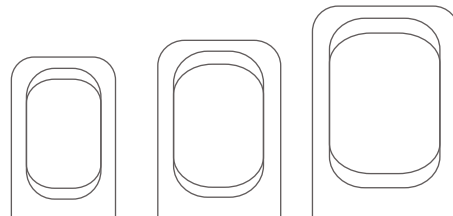

RH-861-01

RH-861-02

RH-861-03



Adenoid Curettes  
Ringmesser  
Cuchillos para adenoides  
Couteaux à végétations adénoïdales  
Coltelli per vegetazioni adenoidee

**LaForce Blade**  
Non-Perforated

Catalog #	Size
RH-861-11	Small
RH-861-12	Medium
RH-861-13	Large



**LaForce Adenotome**  
With Perforated Blade

Catalog #	Size, Profile
RH-863-01	25 cm (9 3/4"), Fig. 1
RH-863-02	25 cm (9 3/4"), Fig. 2
RH-863-03	25 cm (9 3/4"), Fig. 3

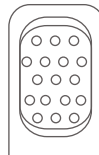

RH-863-01

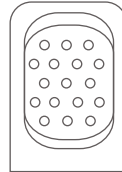

RH-863-02

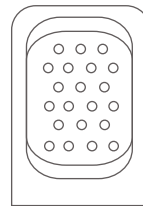

RH-863-03

**LaForce Blade**  
Perforated

Catalog #	Size
RH-863-11	Small
RH-863-12	Medium
RH-863-13	Large



**Eicken-Killian Irrigation**

Catalog #	Size, Diameter
RH-881-20	14 cm (5 1/2"), Ø 2.0 mm
RH-881-25	14 cm (5 1/2"), Ø 2.5 mm
RH-881-30	14 cm (5 1/2"), Ø 3.0 mm





Frontal Sinus Dilators  
Sinus-Dilatatoren  
Dilatadores para el seno  
Dilatateurs pour le sinus frontal  
Dilatatori per il seno frontale

**Ritter-Halle Frontal Sinus Dilator**

Catalog #	Size, Diameter
RH-891-25	14.5 cm (5 3/4"), Ø 2.5 mm
RH-891-30	14.5 cm (5 3/4"), Ø 3.0 mm
RH-891-40	14.5 cm (5 3/4"), Ø 4.0 mm







**SURTEX**  
INSTRUMENTS

*Crafted to Excellence*

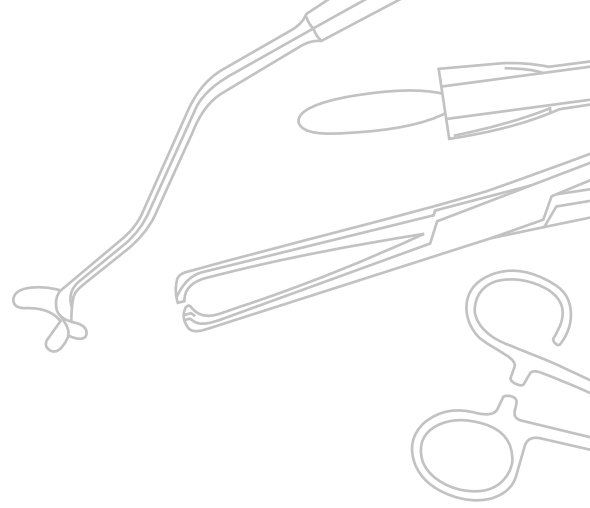

TL



## TONSILLECTOMY, LARYNGO-BRONCHOSCOPY

Surtex Laryngology Instruments are precision crafted to help you minimize trauma when operating on or near delicate vocal cords during laryngeal surgery, microlaryngeal surgery and phonosurgery.

Surtex offers a wide range of Tonsillectomy & Laryngobronchoscopy Instruments in this field of medicine including but not limited to the following tonsil dissectors, knives, tonsil elevators, tonsil ligators, gauze packer, tonsil forceps, tonsil snares, tonsillectomes, tonsil punches, broncho-esophagoscopy forceps, laryngeal forceps, laryngeal mirrors.

Tonsillektomie, Laryngo-Bronchoskopie

Tonsilectomía, Laringo-Bronchoscopia

Tonsillectomie, Laryngo-Bronchoscopie

Tonsilectomia, Laringo-Bronchoscopia



Tonsil Dissector / Retractors  
Tonsillenelevator / Retractor  
Disector / Separador para amígdalas  
Dissecteur / Rétracteur pour amygdalas  
Disettori / Retrattori per tonsille

**Fischer Tonsil / Dissector**

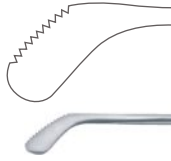

Catalog #	Size
TL-011-21	21.5 cm (8 1/2")

**Abraham Tonsil Knife**



Catalog #	Size
TL-015-19	19 cm (7 1/2")

**Carpenter Tonsil Knife**

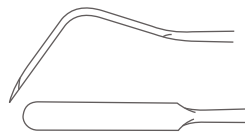

Catalog #	Size, Blade Width
TL-021-25	25 cm (9 3/4"), 4.4 mm, 8.8 mm

**Carpenter Tonsil Dissector**



Catalog #	Size
TL-027-24	24 cm (9 1/2")

**Hurd Tonsil Dissector / Retractor**



Catalog #	Size, Blade Width
TL-031-22	22.5 cm (8 3/4"), 11.0, 14.0 mm

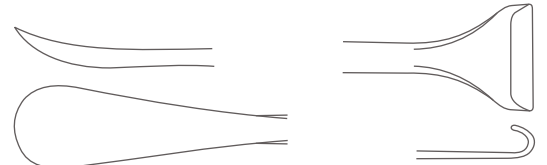





Tonsil Elevator / Retractors  
Tonsil Aufzüge / Wundhaken  
Amígdalas Elevadores / Separadores  
Amygdale Ascenseurs / Ecarteurs  
Tonsille Ascensori / Divaricatori

**Mollison Tonsil Dissector/Retractor**



Catalog #	Size, Blade Width
TL-033-21	21 cm (8 ¼"), 10.0 mm, 10 mm

**Henke Tonsil Elevator**

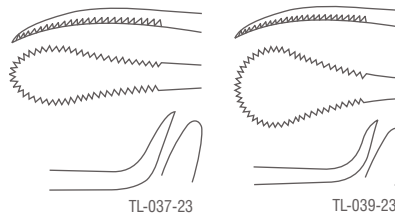

Catalog #	Size, Blade Width
TL-037-23	22.5 cm (8 ¾"), 10.0, 5.0 mm
TL-039-23	22.5 cm (8 ¾"), 16.0, 5.0 mm



**Gwynne-Evans Tonsil Elevator**



Catalog #	Size
TL-043-22	20 cm (8")

**Love Tonsil Retractor**



Catalog #	Size, Blade Width
TL-051-18	20 cm (8"), 18 mm
TL-051-20	23 cm (9"), 20 mm
TL-051-22	23 cm (9"), 22 mm

**Nager Tonsil Retractor**



Catalog #	Size
TL-055-23	23 cm (9")



Tonsil Instruments  
Tonsil Instrumente  
Instrumentos de la amígdala  
Instruments de amygdales  
Strumenti Tonsille

**Hofer Tonsil Retractor**



Catalog #	Size
TL-059-24	24 cm (9 1/2")

**Haslinger Tonsil Retractor**



Catalog #	Size
TL-063-17	17 cm (6 3/4")

**Roeder Tonsil Ligator**



Catalog #	Size
TL-065-00	26.5 cm (10 1/2")

**Luniatschek Gauze Packer**

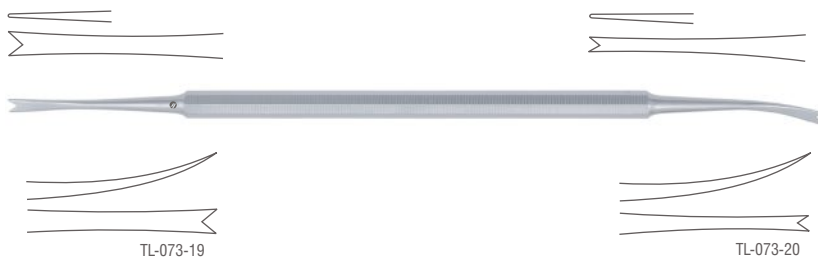

Catalog #	Size, Width
TL-073-19	17.5 cm (7"), 3 mm
TL-073-20	17.5 cm (7"), 2 mm

TL-073-19

TL-073-20

**White Tonsil Grasping Forcep**



Catalog #	Size
TL-101-18	18 cm (7")

INCHES  
MILLIMETERS



Tonsil Instruments  
Tonsil Instrumente  
Instrumentos de la amigdalita  
Instruments de amygdales  
Strumenti Tonsille

**Blohmke Tonsil Grasping Forcep**  
1 x 2 Teeth

Catalog #	Size
TL-105-20	20 cm (8")

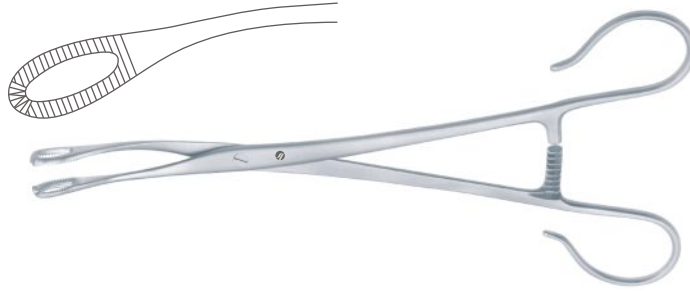

**Schmidt Tonsil Forcep**

Catalog #	Size, Profile
TL-111-19	19 cm (7 1/2"), Slightly Curved
TL-113-19	18.5 cm (7 1/4"), Strongly Curved

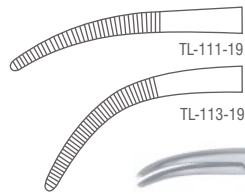

**Wilson Tonsil Artery Forcep**

Catalog #	Size
TL-115-20	20 cm (8")



**Colver Tonsil Grasping Forcep**

Catalog #	Size, Profile
TL-116-19	19 cm (7 1/2"), Straight
TL-117-19	19 cm (7 1/2"), Curved

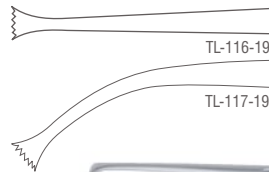

**Denis-Browne Tonsil Holding Forcep**  
Curved

Catalog #	Size
TL-119-22	22 cm (8 1/2")

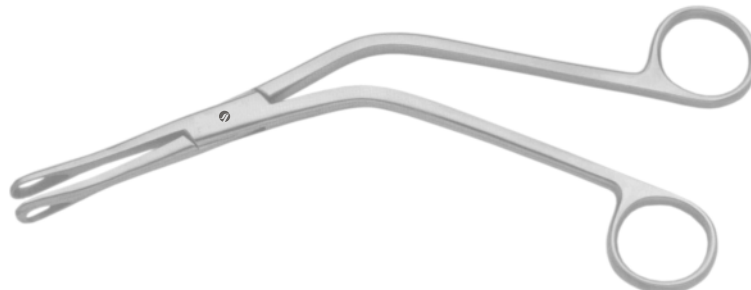



Tonsil Instruments  
Tonsil Instrumente  
Instrumentos de la amigdalada  
Instruments de amygdales  
Strumenti Tonsille

**Museux Tonsil Grasping Forcep**  
Curved



Catalog #	Size
TL-120-20	20 cm (8")

**Eves Tonsil Snare**  
Without Ratchet



Catalog #	Size
TL-150-28	28.5 cm (11 1/4")

**Eves Tonsil Snare**  
With Ratchet



Catalog #	Size
TL-152-28	28.5 cm (11 1/4")

**Bruenings Tonsil Snare**  
With Double Ratchet

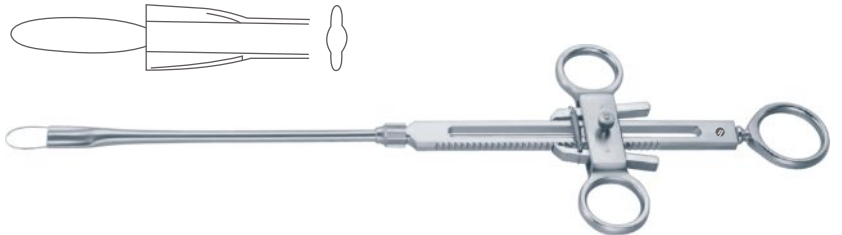

Catalog #	Size
TL-156-29	29 cm (11 1/2")

**Wire Loop for Tonsil Snare**  
Pack of 100

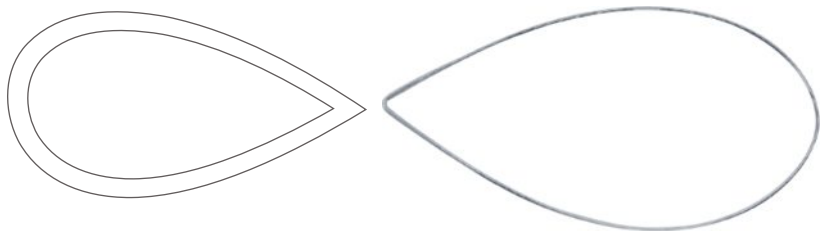

Catalog #	Size, Loop Diameter
TL-161-40	Ø 40.0 mm
TL-161-50	Ø 50.0 mm



Tonsil Instruments  
Tonsil Instrumente  
Instrumentos de la amigdala  
Instruments de amygdales  
Strumenti Tonsille

**Snare Wire**  
Pack of 100

Catalog #	Size, Wire Diameter
TL-163-00	Ø 0.3 mm



**Tyding Tonsil Snare**  
With 1 Straight Tip

Catalog #	Size
TL-173-00	Standard

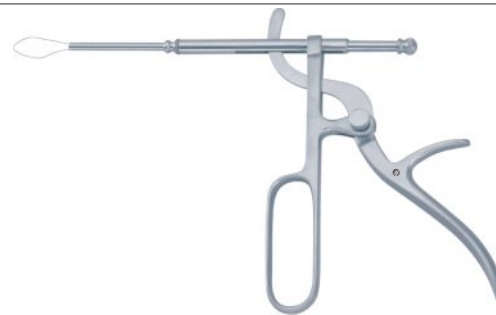

**Sluder-Ballenger Tonsillectome Complete**  
With 3 Tip Ref: TL-183-01 to TL-183-03

Catalog #	Size
TL-181-00	Standard



**Sluder-Ballenger Tonsillectome Handle Only**

Catalog #	Size
TL-181-01	Standard



**Sluder-Ballenger Tonsillectome Tip**

Catalog #	Size, Profile
TL-183-01	N/A, Fig. 1
TL-183-02	N/A, Fig. 2
TL-183-03	N/A, Fig. 3

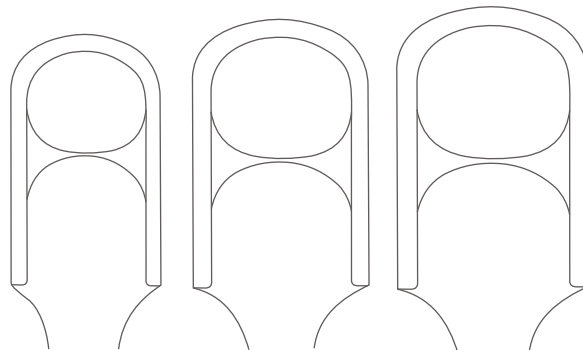

TL-183-01

TL-183-02

TL-183-03



Tonsil Instruments  
Tonsil Instrumente  
Instrumentos de la amigdalas  
Instruments de amygdales  
Strumenti Tonsille

**Corwin Tonsil Haemostat**

Catalog #	Size
TL-191-14	14 cm (5 1/2")

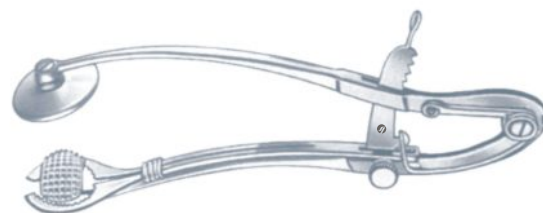

**Hartmann Tonsil Punch**  
Through Cutting

Catalog #	Size, Diameter
TL-201-13	12 cm (4 3/4"), Ø 13.0 mm
TL-201-15	12 cm (4 3/4"), Ø 15.0 mm
TL-201-17	12 cm (4 3/4"), Ø 17.0 mm



**Schmeden Tonsil Punch**  
Through Cutting

Catalog #	Size
TL-213-01	12 cm (4 3/4")
TL-213-02	12 cm (4 3/4")
TL-213-03	12 cm (4 3/4")



**Jurasz**  
Adenoid Cutting Forcep

Catalog #	Size
TL-215-01	21 cm (8 1/4")
TL-215-02	21 cm (8 1/4")

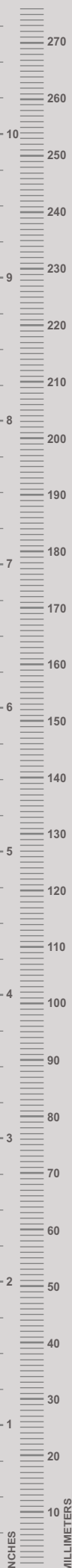
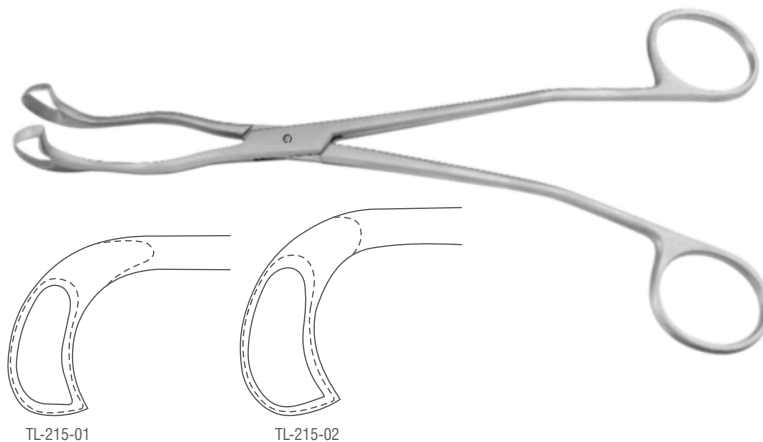



Tonsil Instruments  
Tonsil Instrumente  
Instrumentos de la amigdalas  
Instruments de amygdales  
Strumenti Tonsille

**Huber Universal Handle**

Catalog #	Size
TL-301-01	Standard



**Bruenings Interchangeable Tube**  
Straight

Catalog #	Size
TL-302-20	20 cm (8")
TL-302-30	30 cm (12")
TL-302-40	40 cm (16")



**Bruenings Interchangeable Tube**  
Curved

Catalog #	Size
TL-303-20	20 cm (8")





Tonsil Instruments  
Tonsil Instrumente  
Instrumentos de la amigdalas  
Instruments de amygdales  
Strumenti Tonsille

**Fraenkel Broncho-Esophagoscopy Forcep Tip**

Catalog #	Size
TL-310-01	Standard



**Seiffert Broncho-Esophagoscopy Forcep Tip**

Catalog #	Size
TL-314-01	Standard

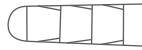

**Fraenkel Broncho-Esophagoscopy Forcep Tip**

Catalog #	Size
TL-318-01	Standard



**Scheinmann Broncho-Esophagoscopy Forcep Tip**

Catalog #	Size
TL-321-01	Standard



**Scheinmann Broncho-Esophagoscopy Forcep Tip**

Catalog #	Size
TL-323-01	Standard







**Bruenings Broncho-Esophagoscopy Forcep Tip**



Catalog #	Size
TL-326-02	Standard
TL-326-03	Standard

**Bruenings Broncho-Esophagoscopy Forcep Tip**



Catalog #	Size
TL-328-02	Standard
TL-328-03	Standard

**Lange Broncho-Esophagoscopy Forcep Tip**



Catalog #	Size
TL-334-01	Standard

**Krause Broncho-Esophagoscopy Forcep Tip**

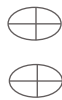

Catalog #	Size
TL-338-01	Standard
TL-338-02	Standard

**Krause Broncho-Esophagoscopy Forcep Tip**



Catalog #	Size
TL-342-01	Standard



Tonsil Instruments  
Tonsil Instrumente  
Instrumentos de la amigdalas  
Instruments de amygdales  
Strumenti Tonsille

**Cordes Broncho-Esophagoscopy Forcep Tip**

Catalog #	Size
TL-347-01	Standard
TL-347-02	Standard
TL-347-03	Standard
TL-347-04	Standard



**Schumacher Broncho-Esophagoscopy Forcep Tip**

Catalog #	Size
TL-349-01	Standard



**Cordes Broncho-Esophagoscopy Forcep Tip**

Catalog #	Size
TL-353-01	Standard
TL-353-02	Standard



**Cordes Broncho-Esophagoscopy Forcep Tip**

Catalog #	Size
TL-357-01	Standard



**Rosenberg Broncho-Esophagoscopy Forcep Tip**

Catalog #	Size
TL-359-01	Standard





**Micro Laryngeal Scissors**

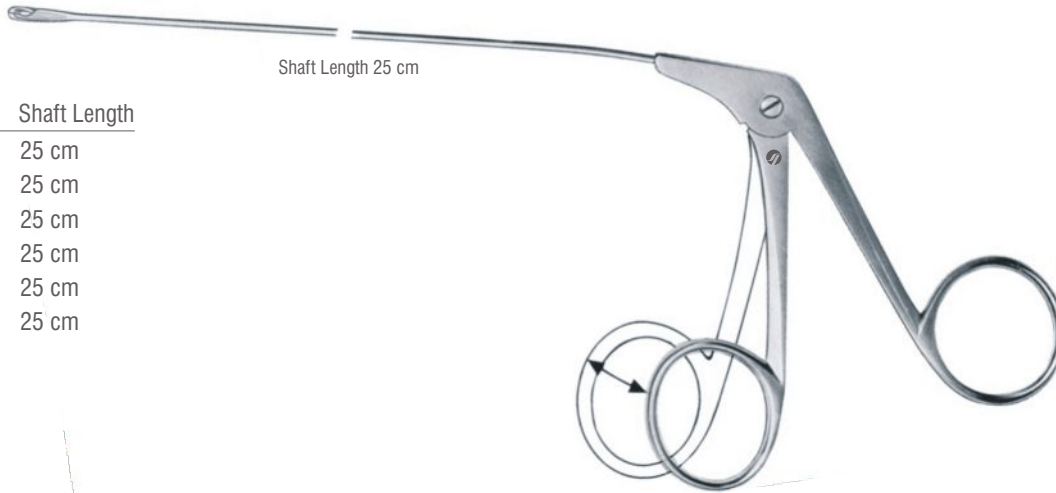

Catalog #	Shaft Length
TL-361-01	25 cm
TL-361-02	25 cm
TL-361-03	25 cm
TL-361-04	25 cm
TL-361-05	25 cm
TL-361-06	25 cm

**Micro Laryngeal Forceps**

Catalog #	Shaft Length
TL-363-01	25 cm
TL-363-02	25 cm
TL-363-03	25 cm
TL-363-04	25 cm
TL-361-05	25 cm

**Micro Scissors**



**Micro Forceps**



**Cup Shaped Forceps  
Ø 2.5 mm**



**Micro Laryngeal Forceps  
Cup Shaped**

Catalog #	Shaft Length, Diameter
TL-365-01	25 cm, Ø 2.5 mm
TL-365-02	25 cm, Ø 2.5 mm
TL-363-03	25 cm, Ø 2.5 mm
TL-363-04	25 cm, Ø 2.5 mm
TL-361-05	25 cm, Ø 2.5 mm
TL-361-06	25 cm, Ø 2.5 mm



Microlaryngeal Instruments  
Mikrolaryngeale Instrumente  
Microlaryngeal Instrumentos  
Instruments de Microlaryngeal  
Strumenti Microlaryngeal

**Micro Laryngeal Forceps \***



Catalog #	Shaft Length
TL-367-01	35 cm
TL-367-02	35 cm
TL-367-03	35 cm
TL-367-04	35 cm, Ø 3.0 mm
TL-367-05	35 cm, Ø 3.0 mm
TL-367-06	35 cm, Ø 3.0 mm
TL-367-07	35 cm, Ø 3.0 mm
TL-367-08	35 cm, Ø 3.0 mm
TL-367-09	35 cm, 2 x 5 mm
TL-367-10	35 cm, 3 x 5 mm
TL-367-11	35 cm

**Micro Laryngeal Forceps \***

Catalog #	Shaft Length
TL-369-01	40 cm
TL-369-02	40 cm
TL-369-03	40 cm
TL-369-04	40 cm
TL-369-05	40 cm
TL-369-06	40 cm
TL-369-07	40 cm
TL-369-08	40 cm
TL-369-09	40 cm
TL-369-10	40 cm
TL-369-11	40 cm
TL-369-12	40 cm
TL-369-13	40 cm

**Micro Laryngeal Forceps \***

Catalog #	Shaft Length
TL-371-01	50 cm
TL-371-02	50 cm
TL-371-03	50 cm
TL-371-04	50 cm
TL-371-05	50 cm
TL-371-06	50 cm
TL-371-07	50 cm
TL-371-08	50 cm
TL-371-09	50 cm
TL-371-10	50 cm
TL-371-11	50 cm
TL-371-12	50 cm
TL-371-13	50 cm

**Micro Laryngeal Forceps \***

Catalog #	Shaft Length
TL-373-01	60 cm
TL-373-02	60 cm
TL-373-03	60 cm
TL-373-04	60 cm
TL-373-05	60 cm
TL-373-06	60 cm
TL-373-07	60 cm
TL-373-08	60 cm
TL-373-09	60 cm
TL-373-10	60 cm
TL-373-11	60 cm
TL-373-12	60 cm
TL-373-13	60 cm

\* Please refer to the images on next page.



Microlaryngeal Instruments  
Mikrolaryngeale Instrumente  
Microlaryngeal Instrumentos  
Instruments de Microlaryngeal  
Strumenti Microlaryngeal

For Children	Shaft 35cm	For Adult	Shaft Size 40 cm	Shaft Size 50 cm	Shaft Size 60 cm
	TL-367-01		TL-369-01	TL-371-01	TL-373-01
	TL-367-02		TL-369-02	TL-371-02	TL-373-02
	TL-367-03		TL-369-03	TL-371-03	TL-373-03
	TL-367-04		TL-369-04	TL-371-04	TL-373-04
	TL-367-05		TL-369-05	TL-371-05	TL-373-05
	TL-367-06		TL-369-06	TL-371-06	TL-373-06
	TL-367-07		TL-369-07	TL-371-07	TL-373-07
	TL-367-08		TL-369-08	TL-371-08	TL-373-08
	TL-367-09		TL-369-09	TL-371-09	TL-373-09
	TL-367-10		TL-369-10	TL-371-10	TL-373-10
	TL-367-11		TL-369-11	TL-371-11	TL-373-11
			TL-369-12	TL-371-12	TL-373-12
			TL-369-13	TL-371-13	TL-373-13



Tonsillectomy Instruments  
Tonsil Instrumente  
Instrumentos de la amígdala  
Instruments de amygdales  
Strumenti Tonsille

**Chevalier-Jackson Square Punch**

Catalog #	Shaft Length
TL-381-30	30 cm (12")
TL-381-40	40 cm (15 3/4")
TL-381-50	50 cm (19 1/2")
TL-381-60	60 cm (23 1/2")



**Chevalier-Jackson Grasping Forcep**

Catalog #	Shaft Length
TL-383-30	30 cm (12")
TL-383-40	40 cm (15 3/4")
TL-383-50	50 cm (19 1/2")
TL-383-60	60 cm (23 1/2")



**Chevalier-Jackson Grasping Forcep**

Catalog #	Shaft Length
TL-385-30	30 cm (12")
TL-385-40	40 cm (15 3/4")
TL-385-50	50 cm (19 1/2")
TL-385-60	60 cm (23 1/2")



**Chevalier-Jackson Cup Shaped Biopsy Forcep  
Straight**

Catalog #	Shaft Length
TL-387-30	30 cm (12")
TL-387-40	40 cm (15 3/4")
TL-387-50	50 cm (19 1/2")
TL-387-60	60 cm (23 1/2")





Tonsillectomy Instruments  
Tonsil Instrumente  
Instrumentos de la amigdala  
Instruments de amygdales  
Strumenti Tonsille

**Chevalier-Jackson Basket Punch**

Catalog #	Shaft Length
TL-389-30	30 cm (12")
TL-389-40	40 cm (15 3/4")
TL-389-50	50 cm (19 1/2")
TL-389-60	60 cm (23 1/2")

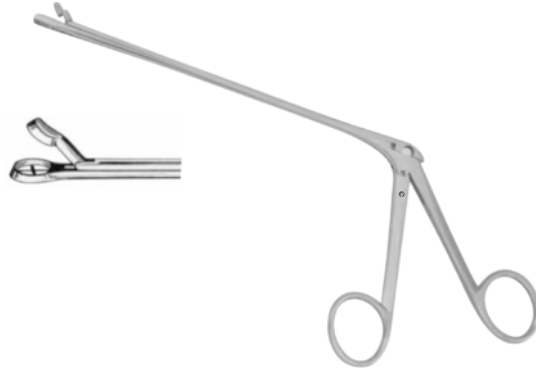

**Chevalier-Jackson Oval Biopsy Forcep**

Catalog #	Shaft Length
TL-391-30	30 cm (12")
TL-391-40	40 cm (15 3/4")
TL-391-50	50 cm (19 1/2")
TL-391-60	60 cm (23 1/2")



**Chevalier-Jackson Cup Shaped Biopsy Forcep**  
Curved Upwards

Catalog #	Shaft Length
TL-393-30	30 cm (12")
TL-393-40	40 cm (15 3/4")
TL-393-50	50 cm (19 1/2")
TL-393-60	60 cm (23 1/2")

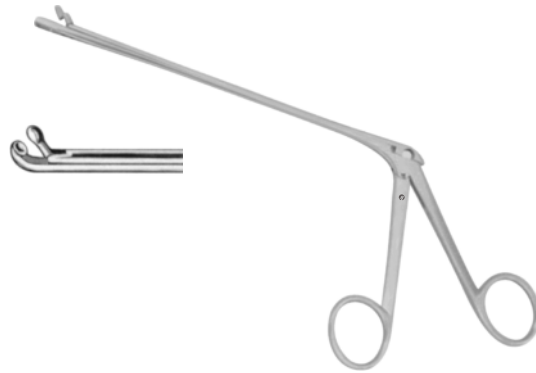

**Micro Laryngeal Scissors**

Catalog #	Size, Profile
TL-395-01	25 cm (9 3/4"), Straight
TL-395-02	25 cm (9 3/4"), Horizontal
TL-395-03	25 cm (9 3/4"), Curved Right
TL-395-04	25 cm (9 3/4"), Curved Left
TL-395-05	25 cm (9 3/4"), Curved Up
TL-395-06	25 cm (9 3/4"), Curved Down





Tonsil Instruments  
Tonsil Instrumente  
Instrumentos de la amígdala  
Instruments de amygdales  
Strumenti Tonsille

**Laryngeal Mirror**  
Rhodium Plated With Fixed Handle

Catalog #	Size, Mirror Diameter, Profile
TL-402-08	18.5 cm (7 1/4"), Ø 8 mm, Fig. 00
TL-402-10	18.5 cm (7 1/4"), Ø 10 mm, Fig. 0
TL-402-12	18.5 cm (7 1/4"), Ø 12 mm, Fig. 1
TL-402-14	18.5 cm (7 1/4"), Ø 14 mm, Fig. 2
TL-402-16	18.5 cm (7 1/4"), Ø 16 mm, Fig. 3
TL-402-18	18.5 cm (7 1/4"), Ø 18 mm, Fig. 4
TL-402-20	18.5 cm (7 1/4"), Ø 20 mm, Fig. 5
TL-402-22	18.5 cm (7 1/4"), Ø 22 mm, Fig. 6
TL-402-24	18.5 cm (7 1/4"), Ø 24 mm, Fig. 7
TL-402-26	18.5 cm (7 1/4"), Ø 26 mm, Fig. 8
TL-402-28	18.5 cm (7 1/4"), Ø 28 mm, Fig. 9
TL-402-30	18.5 cm (7 1/4"), Ø 30 mm, Fig. 10



**Laryngeal Mirror**  
Rhodium Plated Without Handle

Catalog #	Size, Mirror Diameter, Profile
TL-406-08	13.5 cm (5 1/4"), Ø 8 mm, Fig. 00
TL-406-10	13.5 cm (5 1/4"), Ø 10 mm, Fig. 0
TL-406-12	13.5 cm (5 1/4"), Ø 12 mm, Fig. 1
TL-406-14	13.5 cm (5 1/4"), Ø 14 mm, Fig. 2
TL-406-16	13.5 cm (5 1/4"), Ø 16 mm, Fig. 3
TL-406-18	13.5 cm (5 1/4"), Ø 18 mm, Fig. 4
TL-406-20	13.5 cm (5 1/4"), Ø 20 mm, Fig. 5
TL-406-22	13.5 cm (5 1/4"), Ø 22 mm, Fig. 6
TL-406-24	13.5 cm (5 1/4"), Ø 24 mm, Fig. 7
TL-406-26	13.5 cm (5 1/4"), Ø 26 mm, Fig. 8
TL-406-28	13.5 cm (5 1/4"), Ø 28 mm, Fig. 9
TL-406-30	13.5 cm (5 1/4"), Ø 30 mm, Fig. 10







**Michel Laryngeal Mirror**  
With Handle , Moveable Mirror



Catalog #	Size, Mirror Diameter, Profile
TL-413-12	25 cm (9 3/4"), Ø 12 mm, Fig. 1
TL-413-14	25 cm (9 3/4"), Ø 14 mm, Fig. 2
TL-413-16	25 cm (9 3/4"), Ø 16 mm, Fig. 3
TL-413-18	25 cm (9 3/4"), Ø 18 mm, Fig. 4

**Laryngeal Mirror Handle**



Catalog #	Size
TL-420-10	10 cm (4")





**SURTEX**  
INSTRUMENTS

*Crafted to Excellence*

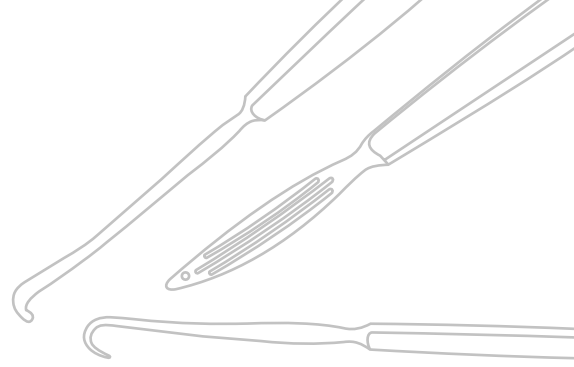

TM

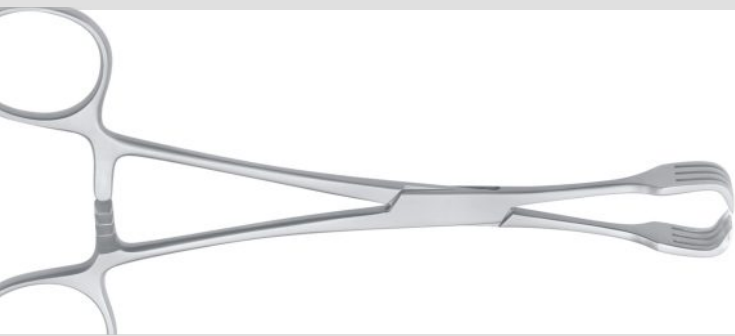

## TRACHEOTOMY INSTRUMENTS

Tracheotomy consists of making an incision on the anterior aspect of the neck and opening a direct airway through an incision in the trachea (windpipe). The resulting stoma(hole), or tracheotomy, can serve independently as an airway or as a site for a tracheotomy tube to be inserted; this tube allows a person to breathe without the use of his or her nose or mouth. Surtex instruments offers a range of tracheotomy instruments for this medical procedure including but not limited to the following tracheal dilators, tracheal retractors, Goitre enucleators and tracheal tubes.

Tracheotomie

Traqueotomía

Trachéotomie

Tracheotomia



Tracheal Dilators, Tracheal Hooks  
 Trachealdilatatoren, Trachealhaken  
 Diladores traqueales, Ganchos traqueales  
 Dilateurs pour la trachéotomie, Ecarteurs pour trachéotomie  
 Dilatori per tracheotomia, Uncini tracheali

**Uckermann Tracheotomy Trocar**



Catalog #	Size, Diameter
TM-101-75	11.5 cm (4 1/2"), Ø 7.5 mm
TM-101-90	11.5 cm (4 1/2"), Ø 9.0 mm

**Laborde Tracheal Dilator**



Catalog #	Size
TM-151-14	14 cm (5 1/2")

**Trousseau Tracheal Dilator**



Catalog #	Size
TM-155-14	14.5 cm (5 3/4")

**Bose Tracheal Retractor**



Catalog #	Size
TM-161-07	7 cm (2 3/4")

**Bose Tracheal Retractor**



Catalog #	Size
TM-165-01	16 cm (6 1/4")
TM-165-02	16 cm (6 1/4")



Tracheal Hooks  
Trachealhaken  
Ganchos traqueales  
Ecarteurs pour trachéotomie  
Uncini tracheali

**Iterson Tracheal Hook**  
Sharp



Catalog #	Size
TM-171-16	17 cm (6 3/4")

**Iterson Tracheal Hook**  
Blunt



Catalog #	Size
TM-173-16	17 cm (6 3/4")

**Schoeborn Tracheal Retractor**



Catalog #	Size
TM-181-21	21 cm (8 1/4")

**Rose Tracheal Retractor**



Catalog #	Size
TM-183-13	13.5 cm (5 1/4")

**Luer Tracheal Retractor**



Catalog #	Size
TM-185-11	11 cm (4 1/2")



Tracheal Hooks, Goitre Enucleator, Goitre Grasping Forceps  
Trachealhaken, Kropfsonden, Kropffasszangen  
Ganchos traqueales, Sondas para bocio, Pinzas para coger el bocio  
Ecarteurs pour trachéotomie, Spatules à goitre, Pincés à goitre  
Uncini tracheali, Sonde per gozzo, Pinze per gozzo

**Lukens Thymus Retractor**

Blunt



Catalog #	Size
TM-189-17	17.5 cm (7")

**Jackson Tracheal Hook**



Catalog #	Size
TM-191-17	18 cm (7")

**Kocher Goiter Enucleator**



Catalog #	Size
TM-201-15	16.5 cm (6 1/2")

**Kocher Goiter Enucleator**

With Eye



Catalog #	Size
TM-203-15	16.5 cm (6 1/2")

**Lahey Goiter Grasping Forcep**

2 x 2 Teeth



Catalog #	Size
TM-250-15	15.5 cm (6")



Goitre Grasping Forceps, Tracheal Tubes  
Kropffasszangen, Trachealkanülen  
Pinzas para coger el bocio, Cánulas traqueales  
Pinces à goitre, Canules tracheales  
Pinze per gozzo, Cannule tracheali

**Lahey Goiter Grasping Forcep**  
3 x 3 Teeth

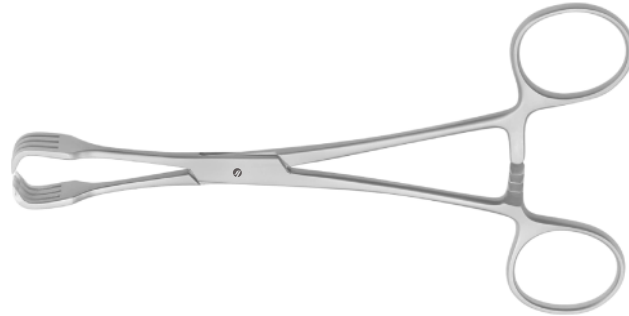

Catalog #	Size
TM-252-15	15.5 cm (6")
TM-252-20	20 cm (8")

**Luer Tracheal Tube**

Catalog #	Size, Profile
TM-301-04	45 mm, Ø 4.0, Fig. 0
TM-301-05	40 mm, Ø 5.0, Fig. 1?
TM-301-06	55 mm, Ø 6.0, Fig. 2
TM-301-07	60 mm, Ø 7.0, Fig. 3
TM-301-08	65 mm, Ø 8.0, Fig. 4?
TM-301-09	70 mm, Ø 9.0, Fig. 5
TM-301-10	75 mm, Ø 10.0, Fig. 6
TM-301-11	80 mm, Ø 11.0, Fig. 7
TM-301-12	85 mm, Ø 12.0, Fig. 8
TM-301-13	90 mm, Ø 13.0, Fig. 9



**Chevalier-Jackson Tracheal Tube**

Catalog #	Size, Profile
TM-321-04	45 mm, Ø 4.0, Fig. 0
TM-321-05	40 mm, Ø 5.0, Fig. 1?
TM-321-06	55 mm, Ø 6.0, Fig. 2
TM-321-07	60 mm, Ø 7.0, Fig. 3
TM-321-08	65 mm, Ø 8.0, Fig. 4?
TM-321-09	70 mm, Ø 9.0, Fig. 5
TM-321-10	75 mm, Ø 10.0, Fig. 6
TM-321-11	80 mm, Ø 11.0, Fig. 7
TM-321-12	85 mm, Ø 12.0, Fig. 8
TM-321-13	90 mm, Ø 13.0, Fig. 9





Tracheal Tubes  
Trachealkanülen  
Cánulas traqueales  
Canules tracheales  
Cannule tracheali

### Speaking Tube

Catalog #	Size, Profile
TM-351-08	65 mm, Fig. 4
TM-351-09	70 mm, Fig. 5
TM-351-10	75 mm, Fig. 6
TM-351-11	80 mm, Fig. 7
TM-351-12	85 mm, Fig. 8
TM-351-13	90 mm, Fig. 9











## TERMS & CONDITIONS

### 1. Definitions

**Company** means Surtex Instruments Ltd (registered in the United Kingdom under registration number 7035724).

**Customer** means the company, firm or organization who's Order for the Goods is accepted by the Company.

**Contract** means the Order accepted by the Company and incorporating these conditions.

**Goods** means the goods which the Company agrees to supply in accordance with these conditions and which are identified on the Order.

**Order** means the order for the purchase of the Goods submitted by the Customer.

- i. Any reference to a law is a reference to it as in force for the time being taking account of any amendment, extension, application or re-enactment and includes any subordinate legislation for the time being in force made under it.
- ii. Where a condition provides for a list of items following the word "including" or "includes", then such list is not to be interpreted as being an exhaustive list.

### 2. Incorporation of Conditions

- i. These conditions shall apply to the Contract to the exclusion of all other terms and conditions, including any terms and conditions which the Customer may purport to apply under any order (including the Order), confirmation of order or similar document or in any correspondence.
- ii. No variation to these conditions shall be binding unless agreed in writing by an authorized representative of the Company.
- iii. The Contract constitutes the entire understanding between the Company and the Customer with respect to the Goods and supersedes all previous agreements and understandings between the parties. The Customer acknowledges that it has not relied upon any statement made orally or in writing by the Company, its employees or agents to the Customer, which are not expressly incorporated into the contract.

### 3. Ordering

- i. Each order (whether submitted by telephone, fax, post, email or electronic ordering system) shall be deemed to be an offer by the Customer to purchase the Goods pursuant to these conditions. The Company may, at its complete discretion, refuse to accept any Order.
- ii. The Customer shall be responsible to the Company for ensuring the accuracy of the terms of any Order (including the description of the Goods ordered).

#### Samples and Free of Charge Goods

- iii. For the avoidance of doubt, where no order is placed and the Company provides Samples, to familiarize the Customer with the goods, as part of a sampling program or where the Company provides Free of Charge Goods to the Customer as part of a clinical trial or compassionate use program these conditions shall, to the extent applicable, apply to such Samples and Free of Charge Goods.

### 4. Price and Payments

- i. Subject to the condition 4.5, unless and otherwise agreed by the Company in writing, the price of the Goods shall be the price listed in the Company's published price list current at the date of the Company's acceptance of the Order. Subject to the condition 4.4, any price may be altered from time to time by the Company on giving not less than thirty days notice to the Customer.
- ii. Standard delivery shall be in accordance with the condition 6.1 or as stated on the Pro Forma offer whichever is greater. If the Customer requires delivery within an alternative time period, the Customer shall contact the Company's customer Support Centre to agree an alternative time period, which will be charged at an additional cost to the Customer. All delivery times are subject to the Goods being in stock at the time of the Company's acceptance of the Order.
- iii. The price is exclusive of VAT and all other applicable taxes and duties, which the Customer shall be additionally liable to pay the Company.
- iv. The Company reserves the right, by giving notice to the Customer at any time before delivery, to increase the price of the Goods to reflect any increase in the cost of the Company which is due to any factor beyond the reasonable control of the Company.
- v. The Customer shall pay the price within ten days of the date of the Company's invoice (the "Due Date"). In the case of payment other than by cash, payment shall only be deemed to have been made on receipt of cleared funds. The time of payment of the price shall be of the essence.
- vi. If the Customer fails to make payment on the due date then the Company shall be entitled to charge the Customer interest (both before and after judgment) on the amount unpaid, in accordance with the Late Payment of Commercial Debts (Interest) Act 1998.
- vii. The Customer shall not in any circumstances or for any reason whatsoever be entitled to make any deduction or withhold any sum from the price by way of set-off or otherwise.
- viii. All payments payable to the Company under the Contract shall become due immediately on its termination, despite any other provision.

### 5. The Goods

- i. The quantity and description of the Goods shall be as set out in the Order.
- ii. The Goods shall be supplied in accordance with the description in the Order. The Company may from time to time make changes to the specification(s) of the Goods, which are required to comply with any applicable safety or statutory requirements or which do not materially affect the quality or fitness for purpose of the Goods.
- iii. The specifications and designs of the Goods (including the copyright, design right and other intellectual property in them) shall as between the parties be and remain the property of the Company.
- iv. The Customer undertakes not to use any trademarks or trade names applied by the Company to the Goods, nor do or permit anything to be done where by the good will or reputation of such trademarks or trade names may be prejudiced or damaged.
- v. All samples must be clearly identified as such, and the Customer must not sell any Samples to any third party.

### 6. Delivery

- i. Subject to the conditions 4.2 and 6.2, delivery of the Goods shall be made to the delivery address specified in the Order normally within 30 days or as stated on the Pro Forma Invoice whichever is greater after the date of the Company's acceptance of the Order.
- ii. The Company reserves the right to withhold delivery of any Goods if any sum due to the Company under any contract with the Customer is overdue or if, in the reasonable opinion of the Company, the financial standing of the customer has been impaired for any other reason.
- iii. Time of delivery shall not be of the essence and, subject to condition 8.6; the Company shall not be liable for any loss or damage whatever due to any failure by the Company to deliver the Goods (or any of them) promptly or at all.



- iv. The Company may deliver the Goods by separate installments. Each separate installment shall be invoiced and paid for in accordance with the provisions of the Contract. Each installment shall be a separate Contract and no cancellation or termination of anyone Contract relating to an installment shall entitle the Customer to repudiate or cancel any other Contractor installment.
- v. The Customer shall take delivery of the Goods promptly whenever they are tendered for delivery (which shall include signing the relevant delivery note). If, for any reason, the Customer fails to take such delivery of the Goods or otherwise causes or requests a delay in delivery:
  - a. The Goods shall be deemed to have been delivered;
  - b. Risk in Goods shall pass to the Customer; and
  - c. The Company shall be entitled to store or arrange for the storage of the Goods until actual delivery, and charge the Customer for the reasonable costs (including insurance) of such storage and any additional charges incurred in delivering the Goods at a later date.
- vi. The Customer shall ensure that adequate and safe facilities and procedures exist at the Customer's premises for the delivery of the Goods.
- vii. The Customer shall immediately notify the Company's Customer Support Centre if the Goods are not received within 30 days of receipt of the invoice.

#### Acceptance of the Goods

- viii. Subject to condition 6.9, the Customer shall be deemed to have accepted the Goods seven days after the date of delivery to the Customer. After acceptance, the Customer shall not be entitled to reject Goods which are not in accordance with the terms of the Contract and the Company shall have no liability whatsoever to the customer in respect of the Goods.
- ix. The Customer must notify to the Company's Customer Support Centre any alleged defect, shortage in quantity, damage, loss or failure to comply with description within seven days of receipt and hold the Goods for inspection by the Company.

#### Return of the Goods

- x. Any requests to return Goods must be made to the Company's Customer Support Centre within seven days after the date of delivery of the Goods to the Customer. Goods which have specialist storage requirements or short expiry dates will not be accepted for return.
- xi. If the company agrees to accept any Goods for return, the Company will issue a "return reference number" and the Customer shall be liable to pay a handling charge of 20% of the price. No return will be accepted after 15 days. Custom-made, made to order, color-coded, etched, and specially sourced instruments are non-returnable. Instruments that have been used/sterilized are also non-returnable. All products being returned should be sent in their original unopened packaging. All Goods must be returned to the Company carriage-paid. The Customer must provide the Company with proof of carriage. For the avoidance of doubt, the Goods shall be at the Customer's risk until return delivery is accepted by the Company.
- xii. Goods returned without the prior written approval of the Company may be returned to the Customer at the absolute discretion of the Company.

#### Recall of the Goods

- xiii. In the event that any Goods are subject to be called by the Company, the Customer shall provide to the Company as much information as is reasonably possible regarding the whereabouts of the Goods.

#### 7. Title and Risk

- i. The Goods shall be at the Customer's risk at the time of delivery, unless the parties have agreed in writing that the Goods are to be collected from the Company's premises, in which case, the Goods shall be at the Customer's risk when the Company notifies the Customer that the Goods are available for collection.
- ii. Property in the Goods shall not pass from the Company until:
  - a. The Customer has paid the price in full; and
  - b. No other sums whatsoever are due from the Customer to the Company.
- iii. Until property in the Goods passes to the Customer in accordance with the condition 7.2, the Customer shall:
  - a. Hold the Goods on a fiduciary basis as bailed for the Company;
  - b. Store the Goods separately from all other goods in its possession and mark them in such a way that they are clearly identified as the Company's property; and
  - b. Maintain the Goods in satisfactory condition and keep them insured on the Company's behalf for their full price.
- iv. The Customer may sell at full market value or use the Goods only in the ordinary course of the Customer's business. Any such sale or dealing shall be a sale or use of the Company's property on the Customer's own behalf and the Customer shall deal as principal when making such sales or dealings. Until property in the Goods passes from the Company, the proceeds of sale or otherwise of the Goods, to the full extent of the price of the Goods, shall be held in trust for the Company and shall not be mixed with other money or paid in to any over drawn bank account and shall be at all material times identified as the Company's money.
- v. The Company shall be entitled to recover the price notwithstanding that property in any of the Goods has not passed from the Company.
- vi. Until such time as property in the Goods passes from the Company, if the Customer:
  - a. Enters into liquidation or has a winding up order made against it or has an administrator, receiver or manager appointed in respect of its assets; or
  - b. Fail to make payment in accordance with these conditions, the Customer shall upon request deliver up to the Company such of the Goods as have not ceased to be in existence or resold. If the Customer fails to do so, the Company may enter upon any premises owned, occupied or controlled by the Customer where the Goods are situated and repossess the Goods.
- vii. The Customer shall not pledge or in any way charge by way of security for any indebtedness, any of the Goods which are the property of the Company. If the Customer does so, all sums whatever owing by the Customer to the Company shall forth with become due and payable.
- viii. On termination of the Contract, howsoever caused, the Company's rights contained in this condition 7 shall remain in effect.

#### 8. Warranties and Liability

- i. Subject as expressly provided in the Contract, all warranties, conditions or other terms implied by statute or common law are excluded to the fullest extent permitted by law.
- ii. Subject as expressly provided in the Contract, all terms and conditions, warranties and representations (whether implied or made expressly) whether by the Company, its servants or agents or otherwise relating to the quality and /or fitness for the purposes of the Goods are excluded to the fullest extent permitted by the law.
- iii. The Company shall be under no liability in respect of any damage arising from fair wear and tear, fire or accident, will full damage, negligence, abnormal working conditions, failure to follow the Company's instructions. Misuse [or unauthorized installation, alteration or repair] of the Goods. The Customer must pass the Company's instructions on to any purchasers or potential users of the Goods.



- iv. The Customer shall indemnify the Company for any losses incurred by the Company in respect of any claim brought for:
  - a. Use of Goods by the Customer in breach of section 6 of the Health and Safety at Work Act etc 1974 or any other relevant safety legislation; or
  - b. Infringement of any patent, copyright or other third party intellectual rights relating to the Goods by the customer.
- v. The Company shall not be liable to the Customer for any indirect or consequential losses (including indirect loss of profit, loss of use, loss of production, loss of business, loss of business opportunity, loss of business revenue and loss of good will) arising under or in connection with the Contract.
- vi. Subject to the condition 8.8, when any valid claim in respect of the Goods is notified to the Company in accordance with these conditions, the Company shall be entitled to repair or replace the Goods (or the part in question) or, at the Company's sole discretion, refund to the Customer the price of the Goods (or proportionate part of the price), and the Company shall have no further liability to the Customer.
- vii. Subject to the condition 8.8, the entire liability of the Company arising under or in connection with the performance of the Contract howsoever arising shall not exceed £5,000,000 (in line with the NHS Purchasing and Supply Agency conditions of contract for the purchase of goods).
- viii. Nothing in these conditions shall exclude or limit the liability of the Company for death or personal injury caused by the Company's negligence, fraud or fraudulent misrepresentation, or any other matter in relation to which it would be illegal for the Company to exclude or attempt to exclude its liability.

#### **9. Force Majeure**

- i. The Company shall not be responsible for any failure to fulfill its obligations under these conditions and/or in relation to the Goods if such failure is caused by an event which is beyond its reasonable control including acts of God, war, armed conflict, acts of terrorism, riot, strikes, industrial action (including action involving the Company's employees), fire, flood, any natural disaster, any defaults by the Company's suppliers or subcontractors, difficulties obtaining workmen or materials, and breakdown of machinery.
- ii. If such event continues for more than one month, the Company may terminate the Contract without liability.

#### **10. Assignment**

- i. The Company may assign the Contractor any part of it to any company, firm or organization.
- ii. The Customer shall not be entitled to assign the Contractor any part of it without the prior written consent of the Company (such consent not to be unreasonably withheld or delayed).

#### **11. Export**

- i. Where the Customer intends to export the Goods from the United Kingdom, the Customer shall be responsible for obtaining all necessary licenses and complying with all applicable legislation and regulations governing the export of the Goods from the United Kingdom and the importation of the Goods into the country of destination and shall be responsible for the payment of all duties on the Goods.

#### **12. Miscellaneous**

- i. All communications between the parties about the Contract shall be in writing and delivered by pre-paid first class post or by hand to the party's registered office, principal place of business or such other address as may at the relevant time have been notified pursuant to this provision to the party giving notice. In the absence of evidence of earlier receipt, any notices shall be deemed to be duly served:
  - a. If sent by first class post, two working days after posting; or
  - b. If delivered personally, when left at the relevant address.
- ii. Save as required to be disclosed by law:
  - a. Where the Customer is an NHS body, both parties, their employees and agents shall at all times keep confidential and secret and shall not disclose to any person the price or specification relating to the Goods (unless otherwise published); or
  - b. Where the Customer is not an NHS body, both parties, their employees and agents shall at all times keep confidential and secret and shall not disclose to any person any information, materials or documents acquired in connection with the Contract which concerns the other party, its employees or business, Unless otherwise disclosed other than due to a failure of the relevant party to comply with the Contract. On termination of the Contract, howsoever caused, the parties' obligations contained in this condition 12.2 shall remain in effect.
- iii. Neither party, its employees or agents shall offer, give or agree to give to any person any gift or consideration of any kind as an inducement or reward for doing or for bearing to do, or for having done or for borne to do, any action in relation to the obtaining or execution of any contract with the other party.
- iv. Each right or remedy of the Company under these conditions is without prejudice to any other right or remedy of the Company.
- v. On termination of the Contract, howsoever caused, all obligations which are expressed to remain in effect shall survive termination of the Contract, together with such conditions the survival of which is implied or is necessary for the interpretation or enforcement of the Contract.
- vi. A person who is not a party to the Contract shall have no rights pursuant to the Contracts (Rights of Third Parties) Act 1999 to enforce any terms of such contract.
- vii. If any provision of the Contract is held to be wholly or partly illegal, invalid, void, voidable, unenforceable or unreasonable it shall. To the extent of such illegality, invalidity, voidness, voidability, unenforceability or unreasonableness, be deemed to be severable and the remaining provisions of the Contract and the remainder of the provision shall continue in full force and effect.
- viii. No waiver or forbearance by the Company (whether express or implied) in enforcing any of its rights under these conditions shall prejudice its right to do so in the future.
- ix. These conditions are subject to the law of England and Wales. All disputes arising in relation to these conditions or the Contract shall be subject to the exclusive jurisdiction of the courts of England and Wales.



ALPHABETICAL INDEX



**SURTEX**  
INSTRUMENTS

*Crafted to Excellence*



## Alphabetical Index

### A

	Page
Abraham Tonsil Knife	112
Adams Napkin Holder	2
Adson Ear Forcep	37
Aiach Columella Suturing Forcep	106
Andrew Tongue Depressor	9
Asch Septum Straightening Forcep	106
Aufricht	
Glabella Rasp	100
Nasal Retractor	104-105
Austin Attic Dissector	55

### B

Ballenger	
Swivel Knife	86
Septum Gouge	91
Ballenger-Hajek Septum Elevator	88
Barbara Micro Ear Pick	50-53
Barnhill Adenoid Curette	108
Barth Ear Scoop	63
Bauer	
Intra Oral Retractor	11-12
Osteotome	22
Beckmann Adenoid Curette	107
Bellucci Micro Scissor	45-46
Beyer Mastoid Rongeur	68
Billeau Ear Loop	64
Bishop Lip & Cheek Retractor	8
Blohmke Tonsil Grasping Forcep	115
Bose Tracheal Retractor,	131
Bruenings	
Tongue Depressor	10
Ethmoid Forcep	80
Tonsil Snare	116
Huber Handle Tube	119
Broncho-Esophagoscopy Forcep Tip	121
Buck Ear Curette	61-62
Buckingham Chisel	57

### C

Carpenter	
Tonsil Knife	112
Tonsil Dissector	112
Cawood-Minnesota Cheek Retractor	8

### C

	Page
Chevalier-Jackson	
Forcep	126-127
Tracheal Tube	134
Cinelli Osteotome	95
Citelli Mastoid Rongeur	68
Coakley Antrum Curette	107
Collin Tongue Holding Forcep	10
Colver Tonsil Grasping Forcep	115
Converse Nasal Retractor	104
Cordes Broncho-Esophagoscopy Forcep Tip	122
Corwin Tonsil Haemostat	118
Cottle	
Nasal Speculum	74-75
Rhinoplasty Knife	85
Septum/Periosteal Elevator	88-90
Osteotome/Chisel	92-93
Chisel	96
Cartilage Crusher	98
Nasal Rasp	100
Alar Hook/Retractor	104-105
Skin Grasping Forcep	106
Cottle-Neivert Alar Hook	103
Cottle-Walsham Septum Straightening Forcep	105
Craig Septum Forcep	
Craig-Dominick Ethmoid Forcep	79

### D

Dautrey-Munro Osteotome	23
Davis-Boyle Mouth Gag	5
Denhart Mouth Gag	3
Dingmann	
Mouth Gag	6-7
Zygoma Elevator	21
Bone Hook	22
Otobrader	57
Dolwick-Type	
TMJ Disc Clamp	24
TMJ Condylar Retractor	24
TMJ Elevator	24
Draffin Bipod	7
Dunn-Dautrey	
Osteotome	23
Elevator	24
Denis-Browne Tonsil Holding Forcep	115





## Alphabetical Index

### E

	Page
Ear Syringe	68-69
Eicken-Killian Irrigation Tube	109
Epker-Bauer Osteotome	22
Eves Tonsil Snare	116

### F

Farrior Ear Speculum	31
Faulkner Antrum Curette	107
Fergusson-Ackland Mouth Gag	3
Fisch Micro Dissector	55
Fischer Tonsil Knife	112
Fomon	
Rhinoplasty Knife	85
Chisel	94
Bone File	99
Nasal Rasp	102-103
Fraenkel Broncho-Esophagoscopy Forcep Tip	120
Freer	
Mucosa Knife	85
Septum Knife	86
Septum Elevator	87-88
Septum Chisel	90-91
Fuller Introducing Forcep	48

### G

Gallaher Antrum Rasp	100
Gillies Zygoma Elevator	21
Gross Ear Scoop/Hook	63
Gruenwald	
Ear Forcep	37-38
Nasal Tampon Forcep	76
Gwynne-Evans Tonsil Elevator	113

### H

Hajek	
Sphenoid Punch	84
Hajek-Kofler Sphenoid Punch	84
Halle, Septum Elevator	87
Hargis	
Medial Ramus Retractor	14

### H

	Page
Mandibular Body Retractor	15
Anterior Border Stripper	15
Periosteal Elevator	15
Periform Rim Retractor	15
Pterygoid Osteotome	16
Bone Holding Forcep	19
Hartmann	
Tongue Depressor	9
Ear Speculum	28-30
Tuning Fork	32-35
Ear Catheter	36
Ear Polypus Forcep	38
Alligator Forcep	40
Ear Hook	64
Nasal Polypus Forcep	78
Nasal Cutting Forcep	82
Tonsil Punch	118
Hartmann-Halle Nasal Speculum	72-73
Hartmann-Hoffmar Alligator Punch	41
Hartmann-Weingartner Alligator Forcep	41
Hartmann-Wullstein Alligator Forcep	39
Haslinger Tonsil Retractor	114
Heister Mouth Gag	2
Henahan Retractor	11
Henke Tonsil Dissector	113
Heymann Septum Forcep	79
Heymann-Knight Nasal Polypus Forcep	78
Hofer Tonsil Retractor	114
House	
Micro Measuring Rod	56
Micro Ear Curette	57
House-Dieter Malleus Nipper	48
Howarth Periosteal Elevator	90
Huber Universal Handle	119
Hurd Tonsil Dissector	112

### I

Iterson Tracheal Hook	132
-----------------------	-----



## Alphabetical Index

### J

	Page
Jackson Tracheal Hook,	133
Jansen	
Ear Forcep	38
Ear Scoop	63
Nasal Tampon Forcep	76
Jansen-Middelton Septum Forcep	83
Jennings Mouth Gag	3
Joseph,	
Rhinoplasty Knife	84-85
Septum Elevator	87
Periosteal Elevator	90
Nasal Saw	97
Bone File	99
Jurasz Adenoid Cutting Forcep	118

### K

Kerrison Sphenoid Punch	84
Killian	
Nasal Speculum	73-74
Nasal Polypus Forcep	78
Septum Elevator	88-89
Septum Gouge	92
Killian-Claus Septum Gouge	92
Kiiner-Doughty Mouth Gag	4-5
Knight Septum Forcep	79
Kocher Goitre Enucleator,	133
Koenig	
Tongue Depressor	10
Tuning Fork	35
Krause	
Polypus Snare	36,75
Broncho-Esophagoscopy Forcep Tip	121
Krause-Voss Polypus Snare	36,75
Kressner Septum Forcep	105

### L

Laborde Tracheal Dilator,	131
LaForce Adenotome	108-109
Lahey Goitre Grasping Forcep,	133-134
Lange	
Alar Hook	103
Broncho-Esophagoscopy Forcep Tip	121
Lange-Wilde Polypus Snare	36

### L

	Page
Langenbeck	
Finger Protector	2
Ear Curette	61
Lempert	
Ear Scoop	63-64
Periosteal Elevator	67-68
Levasseur-Merrill Intra Oral Retractor	12
Lewis Nasal Rasp	100
Littauer	
Ear Polypus Forcep	38
Nasal Polypus Forcep	78
Love Tonsil Retractor	113
Lubet-Barbon Nasal Polypus Forcep	77
Luc Ethmoid Forcep	79-80
Lucae	
Tuning Fork	34
Ear Forcep	37-38
Ear Hook	65
Tympanum Needle	66-67
Luer	
Tracheal Retractor	132
Tracheal Tube	134
Lukens Thymus Retractor	133
Luniatschek Gauze Packer	114

### M

Maltz Nasal Rasp	99, 101
Martin-Simplex Cheek Retractor	8
Masing Periosteal Elevator	90
Maunder Mouth Gag	2
Mayo Tongue Depressor	10
McGee	
Micro Alligator Forcep	41-42
Wire Bending Forcep	47
Micro Ear Needle	52-53
McIvor Mouth Gag	6
McKenty Septum Elevator	87-88
McKesson Mouth Prop	8
Michel Laryngeal Mirror	129
Miller-Colburn Bone File	98
Mini-McGee Micro Alligator Forcep	42
Minnesota Cheek Retractor	9
Mod. Vienna Nasal Speculum	72
Moldnehauser Foreign Body Lever	67
Molt Mouth Gag	3
Museux Tonsil Grasping Forcep	116
Mollison Tonsil Dissector/Retractor	113



## Alphabetical Index

### N

	Page
Nager Tonsil Retractor	113
Negus	
Chest Support for Mouth Gag	4
Tongue Depressor	7
Neivert Nasal Retractor	105
Neivert-Anderson Osteotome	95
Neuro Tuning Fork	35

### O

Obwegeser	
Mouth Gag	2
Lip and Cheek Retractor	8
Soft Tissue Retractor	12-13
Mandibular Retractor	13
Ramus Retractor	13-14
Chin Retractor	14
Channel Retractor	14
Periosteal Elevator	16
J-Stripper	17
Ramus Stripper	17
Awl	19-20
Wire Loop Forcep	20
Septonasal Osteotome	25
Wedge Osteotome	25
Split Osteotome	25
Osteotome	26
Ogura Skin Grasping Forcep	106

### P

Parkes	
Osteotome	97
Bone File	100
Pennington Septum Elevator	89
Petri Intra Oral Retractor	11
Pierce Septum Elevator	89
Plester Flap Knife	49
Politzer	
Furuncle Knife	66
Tympanum Needle	66

### Q

	Page
Quire Foreign Body Forcep	39

### R

Richnau-Holmgren Ear Speculum	31
Ritter-Halle Frontal Sinus Dilator	110
Roeder Tonsil Ligator	114
Roger Periosteal Elevator	89
Rose Tracheal Retractor,	132
Rosen	
Circular Cutting Knife	50
Micro Periosteal Elevator	56
Rosenberg Broncho-Esophagoscopy Forcep Tip	122
Roser-Koenig Mouth Gag	3
Rowe Disimpaction Forcep	21
Rubin	
Septum Forcep	83
Osteotome	94
Russel-Davis Tongue Depressor	7
Rydel-Seiffer Tuning Fork	35

### S

Scheinmann Broncho-Esophagoscopy Forcep Tip	120
Schmeden	
Nasal Cutting Forcep	83
Tonsil Punch	118
Schmidt Tonsil Forcep	115
Schoenborn Tracheal Retractor,	132
Schuknecht Rotary Knife	48
Schumacher Broncho-Esophagoscopy Forcep Tip	122
Seeker	65
Seiffert Broncho-Esophagoscopy Forcep Tip	120
Sexton Myringotomy Knife	49
Shambaugh Micro Ear Needle	54-55
Shapleigh Ear Curette	61
Shea	
Micro Scissor	47
Exploring Hook	55
Micro Ear Curette	57
Sheehan Osteotome	96
Siegle Otoscope	32
Sigmoid Notch Extra Oral Retractor	11
Silver Chisel	96-97
Sluder-Ballenger Tonsillectome	117



## Alphabetical Index

### S

	Page
Smith	
Ramus Separator	20
Sagittal Split Separator	
Snare Wire	36, 117
Speaking Tube	135
St. Clair Thompson Adenoid Curette	108
Stammberger Nasal Cutting Forcep	82
Steinhauser	
Zygomatic Retractor	14
Repositioning Instrument	17
Struempel Alligator Forcep	41
Struycken Nasal Cutting Forcep	82

### T

Tabb Mucosa Knife	49
Takahashi Ethmoid Forcep	80
Tatum Sinus Life Curette	17-19
Terry	
Ramus Pusher	17
Septal Osteotome	25
Thudichum Nasal Speculum	71
Tieck-Halle Nasal Speculum	73
Tilley Ear Polypus Forcep	39
Tobold Tongue Depressor	9
Toynbee Ear Speculum	29
Troeltsch	
Ear Forcep	37
Nasal Tampon Forcep	76
Trousseau Tracheal Dilator	131
Tuning Fork,	33-35
Turvey Palatal Expander	24
Tyding Tonsil Snare	117

### U

Uckermann Tracheotomy Trocar	131
------------------------------	-----

### V

Voltolini Nasal Speculum	72
--------------------------	----

### W

	Page
Wagener Ear Hook	65
Walter Chisel	94
Watson-Williams Ethmoid Forcep	80-81
Weber-Loch Ear Loop	64
Weil-Blakesley Nasal Cutting Forcep	81-82
West	
Septum Chisel	91
Septum Gouge	91
Westmacott Nasal Polypus Forcep	77
White Tonsil Grasping Forcep	114
Whitehead Mouth Gag	4
Wieder Tongue Depressor	9
Wiener Nasal Rasp	101
Wilde Ear Forcep	37
Wullstein	
Micro Scissor	46-47
Sickle Knife	49
Wilson Tonsil Artery Forcep	115

### Y

Young Tongue Holding Forcep	11
-----------------------------	----

### Z

Zaufal Foreign Body Forcep	67
Zoellner	
Ear Speculum	30
Micro Ear Needle	58-59
Micro Ear Knife	59
Tympanum Needle	60
Raspatory	60
Application Instrument	









#### COPYRIGHT NOTICE

The copyright, trademarks, domain names and other intellectual property rights in all materials and information in this presentation belongs to Surtex Instruments Ltd. All rights are reserved. Technical alterations are possible. This presentation may be used for no other purpose than offering, buying and selling of Surtex Instruments products. No part may be reproduced or copied in any form. In the event of misuse we retain the right to recall our catalogues and take appropriate legal action.

#### DISCLAIMER

This documents provides general information about Surtex Instruments Ltd, its products and services, and summarises general capabilities and offerings, which we deem to be relevant to our customers. Whilst Surtex Instruments has taken appropriate steps to ensure the accuracy of the information contained in the document Surtex Instruments gives no warranty regarding the accuracy or completeness of such information.

The presentation was prepared to provide information and does not constitute a contract. Surtex reserves the right, without prior notice, to change, delete, supplement, or otherwise amend at any time the information, images and offerings contained in the presentation or other documents. Surtex shall not be liable for any loss or damage of whatever nature (whether direct, indirect, consequential or other) may arise as a result of any third party relying on the information contained in this document.

For further detailed information, prices, terms and conditions, customer should contact Surtex Instruments at [sales@surtex-instruments.co.uk](mailto:sales@surtex-instruments.co.uk).

© 2020 SURTEX INSTRUMENTS. ALL RIGHTS RESERVED. PRINTED IN UNITED KINGDOM. BT1-01 Rev 1.0



Unit 202 Kingspark Business Centre  
152-178 Kingston Road, New Malden  
Surrey KT3 3ST United Kingdom  
Phone: +44 (0) 208 123 3513

E-mail: [sales@surtex-instruments.co.uk](mailto:sales@surtex-instruments.co.uk)  
Website: [www.surtex-instruments.co.uk](http://www.surtex-instruments.co.uk)



A member of the ABHI



Association of  
British HealthTech  
Industries

Health Tech **For Life**