



**SURTEX**  
INSTRUMENTS

*Crafted to Excellence*

Self-Retaining Retractors, for Skull Mounting  
 Retraktoren zur Fixation am Schädel  
 Separadores para la fijación del cráneo  
 Ecarteurs autofixant au crâne  
 Autofissator per retrattori, per il supporto del cranio



**NS-010-01**  
**Yasargil (Leyla) Brain Single Arm Retractor**  
 Complete

**Includes**

- 1 X NS-010-10
- 1 X NS-012-09
- 1 X NS-012-20
- 1 X NS-012-40
- 1 X NS-010-45



**NS-010-02**  
**Yasargil (Leyla) Brain Double Arm Retractor**  
 Complete

**Includes**

- 1 X NS-010-10
- 1 X NS-012-09
- 1 X NS-012-20
- 1 X NS-012-25
- 1 X NS-010-45



**NS-010-10**  
**Yasargil (Leyla) Flexible Arm**  
 Complete

Self-Retaining Retractors, for Skull Mounting  
 Retraktoren zur Fixation am Schädel  
 Separadores para la fijación del cráneo  
 Ecarteurs autofixant au crâne  
 Autofissator per retrattori, per il supporto del cranio



**NS-010-21**  
 Yasargil (Leyla) Fixation Base



**NS-010-22**  
 Yasargil (Leyla) Fixation Base



**NS-010-30**  
 Yasargil (Leyla) Fixation Base



**NS-010-40**  
 Yasargil (Leyla) Support For Round Spatulas



**NS-010-45**  
 Yasargil (Leyla) Support For Flat Spatulas

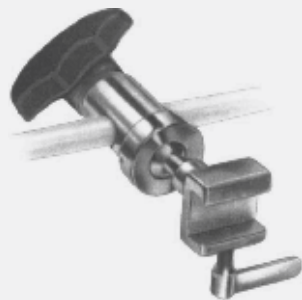

Yasargil (Leyla) Ball and Socket Joint

**NS-012-09**  
 9 x 32 mm

**NS-012-10**  
 10 x 25 mm



**NS-012-20**  
 Yasargil (Leyla) Holding Rod



Vertebral Distractor  
Wirbeldistraktor  
Distractor vertebral  
Distracteur vertébral  
Distrattore vertebrale



**NS-012-25**  
Yasargil (Leyla) Coupling Head

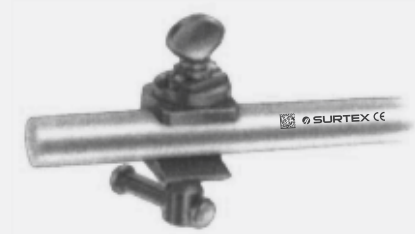

**NS-012-40**  
Yasargil (Leyla) Coupling Head



**NS-016-01**  
Caspar Vertebral Distractor  
Right, 80 mm



**NS-020-02**  
Caspar Drill Guide  
Right



**NS-022-01**  
Caspar Vertebral Distractor  
Left, 80 mm



**NS-022-02**  
Caspar Drill Guide  
Left

Vertebral Distractor  
Wirbeldistraktor  
Distractor vertebral  
Distracteur vertébral  
Distrattore vertebrale

NS

NEUROSURGERY



**NS-024-00**  
**Caspur Twist Drill**  
Ø 1.7 mm  
Overall Length 14.5 cm (5 ½")



**NS-026-12**  
12.0 mm  
**NS-026-14**  
14.0 mm  
**NS-026-16**  
16.0 mm  
**NS-026-18**  
18.0 mm

**Caspur Distraction Screw**



**NS-028-20**  
**Caspur Screw Driver**  
Overall Length 20 cm (8")

Vertebral Body Dissector, Laminectomy Retractors, Self-Retaining  
Dissektor für Wirbelkörper, Laminektomie-Retraktoren, selbsthaltend  
Disector de cuerpo vertebral, Separadores de laminectomía, autoestáticos  
Dissecteur du corps vertébral, Écarteurs de laminectomie, autostatiques  
Dissettore del corpo vertebrale, Divaricatori per laminectomia, autostatici



**Caspar Vertebral Body Dissector**  
Overall Length 20.5 cm (8")



**NS-029-01**  
Flat Tip



**NS-029-02**  
Bevelled Tip



**Meyerding Hemi-Laminectomy Retractor**  
Overall Length 20 cm (8")

**NS-031-32**  
32 x 25 mm

**NS-031-44**  
44 x 25 mm

**NS-031-54**  
54 x 25 mm

**NS-031-60**  
60 x 25 mm

Laminectomy Retractors, Self-Retaining  
Laminektomie-Reraktoren, selbsthaltend  
Separadores de laminectomia, autoestáticos  
Écarteurs de laminectomie, autostatiques  
Divaricatori per laminectomia, autostatici



- NS-033-40**  
40 x 25 mm
- NS-033-50**  
50 x 25 mm
- NS-033-60**  
60 x 25 mm



- NS-035-40**  
40 x 25 mm
- NS-035-50**  
50 x 25 mm
- NS-035-60**  
60 x 25 mm

**Markham-Meyerdig Hemi-Laminectomy Retractor**  
Right Solid Blade  
Overall Length 20 cm (8")

**Markham-Meyerdig Hemi-Laminectomy Retractor**  
Left Solid Blade  
Overall Length 20 cm (8")



**Williams Discectomy Retractor**  
Overall Length 17 cm (6 3/4")

- NS-037-01**  
10 x 50 mm  
Left Solid Blade
- NS-037-02**  
10 x 60 mm  
Left Solid Blade
- NS-037-03**  
10 x 70 mm  
Left Solid Blade
- NS-037-04**  
20 x 50 mm  
Left Solid Blade
- NS-037-05**  
20 x 60 mm  
Left Solid Blade
- NS-037-06**  
20 x 70 mm  
Left Solid Blade

- NS-039-01**  
10 x 50 mm  
Right Solid Blade
- NS-039-02**  
10 x 60 mm  
Right Solid Blade
- NS-039-03**  
10 x 70 mm  
Right Solid Blade
- NS-039-04**  
20 x 50 mm  
Right Solid Blade
- NS-039-05**  
20 x 60 mm  
Right Solid Blade
- NS-039-06**  
20 x 70 mm  
Right Solid Blade

Wire Saws, Skull Traction Tongs  
 Drahtsägen, Schädelhalter  
 Sierras de hilo, Estribos de tracción craneal  
 Fils-scies, Pinces de traction crânienne  
 Fili sega, Pinze per trazione craniale



**Gigli Wire Saw**

- NS-050-30**  
30 cm (11 3/4")
- NS-050-40**  
40 cm (15 3/4")
- NS-050-50**  
50 cm (19 3/4")
- NS-050-60**  
60 cm (23 1/2")
- NS-050-70**  
70 cm (27 1/2")



**NS-055-00**  
**Gigli Wire Saw Handle**  
Pair



**NS-058-00**  
**De Martel Wire Saw Guide**  
Overall Length 33 cm (13")



**NS-061-01**  
**Crutchfield Skull Traction Tongs**  
Small Pattern



**NS-061-02**  
**Crutchfield Skull Traction Tongs**  
Medium Pattern



Skull Traction Tongs  
Schädelhalter  
Estribos de tracción craneal  
Pincès de traction crânienne  
Pinze per trazione craniale



**NS-065-35**  
3.5 mm

**NS-065-50**  
5.0 mm

**Crutchfield Drill Point**  
Overall Length 7 cm (2 3/4")



**NS-071-00**  
**Skull Traction Tongs**  
Large Pattern



**NS-075-01**  
**Spare Pin**



**NS-075-02**  
**Wrench**

NS

NEUROSURGERY



Cranial Rongeurs  
Schädelzangen  
Pinzas sacabocados craneales  
Pincas emporte-pièces crâniennes  
Pinze per craniectomia



**NS-081-15**  
**Adson Drill Guide & Dura Protector**  
Overall Length 15 cm (6")



**NS-083-21**  
**Bacon Cranial Rongeur**  
Overall Length 21 cm (8 1/4")



**NS-086-20**  
**Adson Cranial Rongeur**  
Overall Length 20 cm (8")

**NS-086-20**  
Straight

**NS-087-20**  
Curved



**NS-091-20**  
**Dahlgren Cranial Rongeur**  
Overall Length 20 cm (8")



**NS-093-21**  
**De Vilbiss Cranial Rongeur**  
Overall Length 20.5 cm (8")

Clips and Applying Forceps  
Clips und Anlegezangen  
Grapas y pinzas aplicadoras  
Clips et pinces pour appliquer  
Agrafes e pinze per applicare

NS

NEUROSURGERY



**NS-095-22**  
**Cone Cranial Punch**  
Overall Length 22.5 cm (8 ¾")



**NS-097-21**  
**Dura Strip Dissection Forcep**  
Angled  
Overall Length 21.5 cm (8 ½")



**NS-100-00**  
**Raney Scalp Clip**  
Pack of 10



**NS-102-00**  
**Raney Applying-Removal Forcep**  
Overall Length 15.5 cm (6")



**NS-112-19**  
**McKenzie Clip Applying Forcep**  
Overall Length 18.5 cm (7 ¼")

Clips and Applying Forceps  
Clips und Anlegezangen  
Grapas y pinzas aplicadoras  
Clips et pinces pour appliquer  
Agrafes e pinze per applicare



**NS-115-14**  
**Olivecrona-Toennis Clip Applying Forcep**  
Shaft Length 140 mm



**NS-118-00**  
**Silver Brain Clip**  
Pack of 100



**NS-120-01**  
Ø 7.0 mm  
31 cm (12 1/8")

**NS-120-02**  
Ø 9.0 mm  
41 cm (16")

**Yasargil Galea Hook**  
Spring

Dissectors  
Dissektoren  
Disecadores  
Dissecteurs  
Dissettori

NS

NEUROSURGERY



**NS-151-21**  
**Davis Dura Dissector**  
5.5 mm  
Overall Length 21.5 cm (8 1/2")



**NS-153-24**  
**Davis Dura Dissector**  
6.0 mm / 6.0 mm  
Double Ended  
Overall Length  
24.5 cm (9 3/4")



**NS-155-01**  
**Frazier Dura Dissector**  
5 x 19 mm  
Overall Length 15 cm (6")

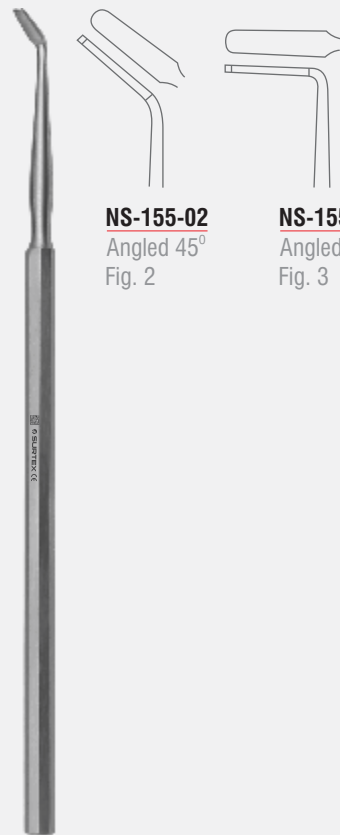

**Hoen Dura Dissector**  
3.5 x 15 mm  
Overall Length 15 cm (6")

**NS-155-02**  
Angled 45°  
Fig. 2

**NS-155-03**  
Angled 90°  
Fig. 3

Dissectors  
Dissektoren  
Disecadores  
Dissecteurs  
Dissettori



**NS-157-16**  
**Love-Adson Dura Dissector**  
5.5 mm  
Overall Length 16 cm (6 1/2")



**NS-159-26**  
**Toennis Dura Dissector**  
Overall Length 26 cm (10 1/4")



**NS-161-01**  
**Olivecrona Dura Dissector**  
Overall Length 24 cm (9 1/2")



**NS-161-02**  
**Olivecrona Dura Dissector**  
Overall Length 18 cm (7")



Dissectors  
Dissektoren  
Disecadores  
Dissecteurs  
Dissettori

NS

NEUROSURGERY



**NS-161-03**  
**Olivecrona Dura Dissector**  
Overall Length 24 cm (9 1/2")



**NS-161-04**  
**Olivecrona Dura Dissector**  
Overall Length 20.5 cm (8")



**NS-163-21**  
**Sachs Dura Dissector**  
3.5 mm, Sharp  
Overall Length 20.5 cm (8")



**NS-165-21**  
**Milligan Dura Dissector**  
Overall Length 21.5 cm (8 1/2")



Dissectors  
Dissektoren  
Disecadores  
Dissecteurs  
Dissettori



**NS-167-22**  
**Dura Dissector**  
Overall Length 22 cm (8 3/4")



**NS-171-01**  
**Penfield Dura Dissector**  
Fig. 1  
Overall Length 17.5 cm (7")



**NS-171-02**  
**Penfield Dura Dissector**  
Fig. 2  
Overall Length 19.5 cm (7 3/4")



**NS-171-03**  
**Penfield Dura Dissector**  
Fig. 3  
Overall Length 19.5 cm (7 3/4")



Dissectors  
Dissektoren  
Disecadores  
Dissecteurs  
Dissettori

NS

NEUROSURGERY



**NS-171-04**  
**Penfield Dura Dissector**  
3.2 mm  
Fig. 4  
Overall Length 20.5 cm (8")



**NS-171-05**  
**Penfield Dura Dissector**  
6.4 mm / 7.3 mm  
Fig. 5  
Overall Length 18 cm (7")



**NS-181-20**  
**Horsley Dura Elevator**  
5.0 mm x 47 mm  
Overall Length 20 cm (8")



**NS-183-21**  
**Sachs Dura Elevator**  
6.0 mm  
Overall Length 21 cm (8 1/4")

Nerve Root Retractors  
Nervwurzelhaken  
Separadores para la raíz de nervio  
Retracteurs pour racines nerveuses  
Uncini per le radici die nervi

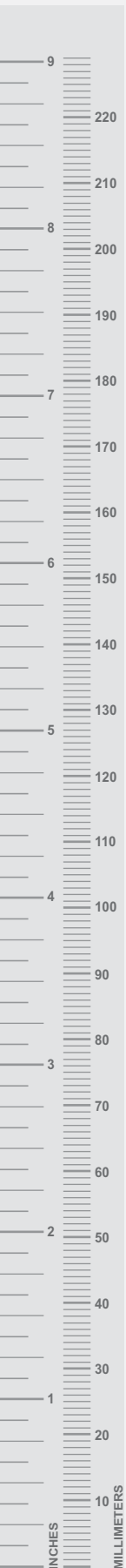

**NS-190-21**  
**Love Nerve Root Retractor**  
7.0 mm  
Straight  
Overall Length 21.5 cm (8 1/2")



**NS-191-18**  
**Love Nerve Root Retractor**  
7.0 mm  
Angled 45°  
Overall Length 17.5 cm (7")



**NS-193-11**  
**Love Nerve Root Retractor**  
7.0 mm  
Angled 90°  
Overall Length 11 cm (4 1/4")

Nerve Root Retractors  
Nervwurzelhaken  
Separadores para la raíz de nervio  
Retracteurs pour racines nerveuses  
Uncini per le radici die nervi

NS

NEUROSURGERY



**NS-195-21**  
**Love Nerve Root Retractor**  
4.0 mm  
Overall Length 22 cm (8 3/4")



**Caspar Nerve Root Retractor**  
Overall Length 24 cm (9 1/2")

**NS-196-04**  
4.0 mm

**NS-196-06**  
6.0 mm

**NS-196-08**  
8.0 mm

**NS-196-10**  
10.0 mm



**Hess Nerve Root Retractor**  
Overall Length 17.5 cm (7")

**NS-197-03**  
3.0 mm

**NS-197-05**  
5.0 mm

**NS-197-07**  
7.0 mm

Nerve Root Retractors  
Nervwurzelhaken  
Separadores para la raíz de nervio  
Retracteurs pour racines nerveuses  
Uncini per le radici die nervi



**NS-200-23**  
**Scoville Nerve Root Retractor**  
8.0 mm  
Overall Length 23.5 cm (9 1/4")



**NS-201-24**  
**Holsher Nerve Root Retractor**  
8.0 mm  
Overall Length 23.5 cm (9 1/4")



**NS-203-19**  
**Scoville Nerve Root Retractor**  
8.0 mm  
Overall Length 16.5 cm (6 1/2")

Nerve Root Retractors, Brain Spatulas  
 Nervwurzelhaken, Hirnspatel  
 Separadores para la raiz de nervio, Espátulas cerebrales  
 Retracteurs pour racines nerveuses, Spatules cérébrales  
 Uncini per le radici die nervi, Spatole cerebrali

NS

NEUROSURGERY



**NS-205-21**  
**Campbell Nerve Root Retractor**  
 10.0 mm  
 Malleable  
 Overall Length 21.5 cm (8 1/2")



**Cushing Brain Spatulas**  
 Overall Length 18 cm (7")

- NS-210-07**  
7 + 9 mm
- NS-210-11**  
11 + 13 mm
- NS-210-15**  
15 + 18 mm
- NS-210-18**  
18 + 22 mm



**Olivecrona Brain Spatulas**  
 Convex  
 Overall Length 18 cm (7")

- NS-213-07**  
7 + 9 mm
- NS-213-11**  
11 + 13 mm
- NS-213-15**  
15 + 18 mm
- NS-213-18**  
18 + 22 mm



Brain Spatulas  
Hirnspatel  
Espátulas cerebrales  
Spatules cérébrales  
Spatole cerebrali

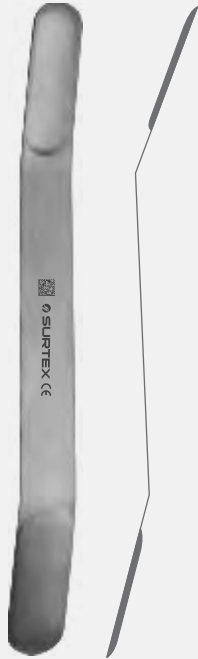

- NS-215-07**  
7 + 9 mm
- NS-215-11**  
11 + 13 mm
- NS-215-15**  
15 + 18 mm
- NS-215-18**  
18 + 22 mm

**Olivecrona Brain Spatulas**  
Convex  
Overall Length 18 cm (7")



- NS-218-07**  
7 + 8 mm
- NS-218-10**  
10 + 11 mm
- NS-218-13**  
13 + 14 mm
- NS-218-15**  
15 + 17 mm
- NS-218-17**  
19 + 20 mm
- NS-218-22**  
22 + 22 mm

**Heifetz Brain Spatulas**  
Overall Length 20 cm (8")



- NS-221-08**  
8.0 mm
- NS-221-11**  
11.0 mm
- NS-221-14**  
14.0 mm
- NS-221-17**  
17.0 mm
- NS-221-20**  
20.0 mm

**Heifetz Brain Spatulas**  
Round Handle  
Overall Length 20 cm (8")



- NS-224-12**  
12.0 mm
- NS-224-17**  
17.0 mm

**Brain Spatulas**  
Malleable  
Overall Length 20 cm (8")



- NS-226-13**  
6/13 mm
- NS-226-17**  
9/17 mm

**Brain Spatulas Conical**  
Malleable  
Overall Length 20 cm (8")

Nerve Hooks  
Nervhaken  
Ganchos para nervios  
Crochets à nerfs  
Uncini per nervi



**NS-231-17**  
17 cm (6 3/4")

**NS-233-21**  
21 cm (8 1/4")

**Smithwick Nerve Hook**



**NS-234-20**  
4.0 mm  
Sharp

**NS-235-20**  
4.0 mm  
Blunt

**Adson Dura Hook**  
Overall Length 20 cm (8")



**NS-236-01**  
3.0 mm  
Sharp

**NS-236-02**  
3.0 mm  
Blunt

**Cairns Dura Hook**  
Overall Length 12.5 cm (5")



**NS-237-16**  
**Graham Dura Hook**  
Blunt  
Overall Length 16.5 cm (6 1/2")



**NS-239-18**  
**Sachs Dura Hook**  
Sharp  
Overall Length 18 cm (7")



Nerve Hooks  
Nervhaken  
Ganchos para nervios  
Crochets à nerfs  
Uncini per nervi



**NS-241-18**  
**Frazier Dura Hook**  
Sharp  
Overall Length 18 cm (7")



**NS-245-22**  
**Hoen Nerve Retractor**  
6.0 mm  
Overall Length 22 cm (8 3/4")



**Dandy Nerve Retractor**  
Overall Length 20 cm (8")

**NS-251-01**  
5.0 mm  
Straight



**NS-251-02**  
5.0 mm  
Right



**NS-251-03**  
5.0 mm  
Left





Dura Knives  
Duramesser  
Bisturís para duramadre  
Bistouries pour duremère  
Bisturi per duramadre

NS

NEUROSURGERY



**NS-253-29**  
**Smithwick Nerve Retractor**  
1.0 mm x 10.0 mm / 5.0 mm  
Semi Sharp  
Overall Length 29 cm (11 ½")



**NS-261-15**  
**Toennis Nerve Retractor**  
Overall Length 15 cm (6")



**NS-280-18**  
**Toennis Brain Knife**  
Overall Length 18 cm (7")





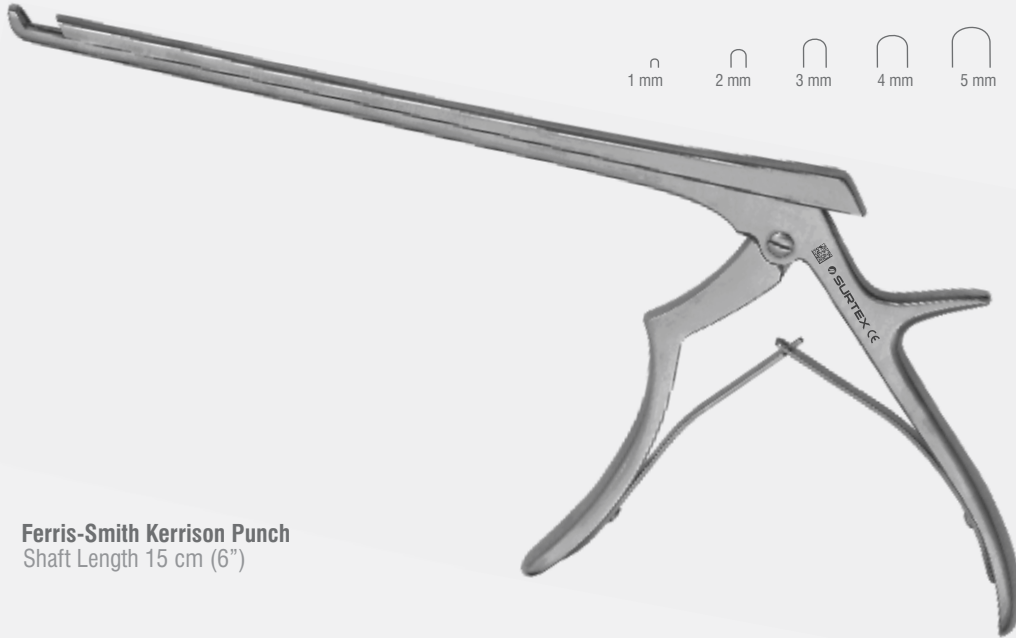

**NS-282-20**  
**Halle Brain Knife**  
Overall Length 20 cm (8")

Laminectomy Punches  
Laminektomiestanzen  
Pinzas cortantes para laminectomia  
Pincas emporte-pièces à laminectomie  
Pinze taglianti per laminectomia



**Ferris-Smith Kerrison Punch**  
Shaft Length 15 cm (6")

 Up Cutting	 Down Cutting	 40° Forward Up Cutting (40°/ 130°)	 40° Forward Down Cutting				
<b>NS-300-01</b> 1.0 mm Regular	<b>NS-300-01 T</b> 1.0 mm Thin Footplate	<b>NS-301-01</b> 1.0 mm Regular	<b>NS-301-01 T</b> 1.0 mm Thin Footplate	<b>NS-302-01</b> 1.0 mm Regular	<b>NS-302-01 T</b> 1.0 mm Thin Footplate	<b>NS-303-01</b> 1.0 mm Regular	<b>NS-303-01 T</b> 1.0 mm Thin Footplate
<b>NS-300-02</b> 2.0 mm Regular	<b>NS-300-02 T</b> 2.0 mm Thin Footplate	<b>NS-301-02</b> 2.0 mm Regular	<b>NS-301-02 T</b> 2.0 mm Thin Footplate	<b>NS-302-02</b> 2.0 mm Regular	<b>NS-302-02 T</b> 2.0 mm Thin Footplate	<b>NS-303-02</b> 2.0 mm Regular	<b>NS-303-02 T</b> 2.0 mm Thin Footplate
<b>NS-300-03</b> 3.0 mm Regular	<b>NS-300-03 T</b> 3.0 mm Thin Footplate	<b>NS-301-03</b> 3.0 mm Regular	<b>NS-301-03 T</b> 3.0 mm Thin Footplate	<b>NS-302-03</b> 3.0 mm Regular	<b>NS-302-03 T</b> 3.0 mm Thin Footplate	<b>NS-303-03</b> 3.0 mm Regular	<b>NS-303-03 T</b> 3.0 mm Thin Footplate
<b>NS-300-04</b> 4.0 mm Regular	<b>NS-300-04 T</b> 4.0 mm Thin Footplate	<b>NS-301-04</b> 4.0 mm Regular	<b>NS-301-04 T</b> 4.0 mm Thin Footplate	<b>NS-302-04</b> 4.0 mm Regular	<b>NS-302-04 T</b> 4.0 mm Thin Footplate	<b>NS-303-04</b> 4.0 mm Regular	<b>NS-303-04 T</b> 4.0 mm Thin Footplate
<b>NS-300-05</b> 5.0 mm Regular	<b>NS-300-05 T</b> 5.0 mm Thin Footplate	<b>NS-301-05</b> 5.0 mm Regular	<b>NS-301-05 T</b> 5.0 mm Thin Footplate	<b>NS-302-05</b> 5.0 mm Regular	<b>NS-302-05 T</b> 5.0 mm Thin Footplate	<b>NS-303-05</b> 5.0 mm Regular	<b>NS-303-05 T</b> 5.0 mm Thin Footplate

Laminectomy Punches  
Laminektomiestanzen  
Pinzas cortantes para laminectomía  
Pinces emporte-pièces à laminectomie  
Pinze taglienti per laminectomia

NS

NEUROSURGERY

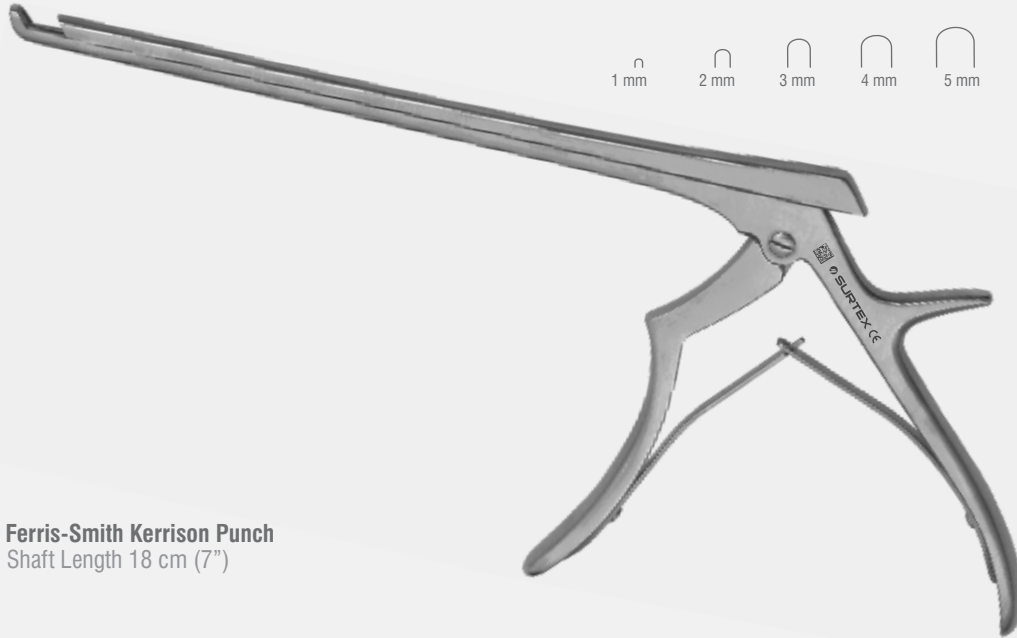



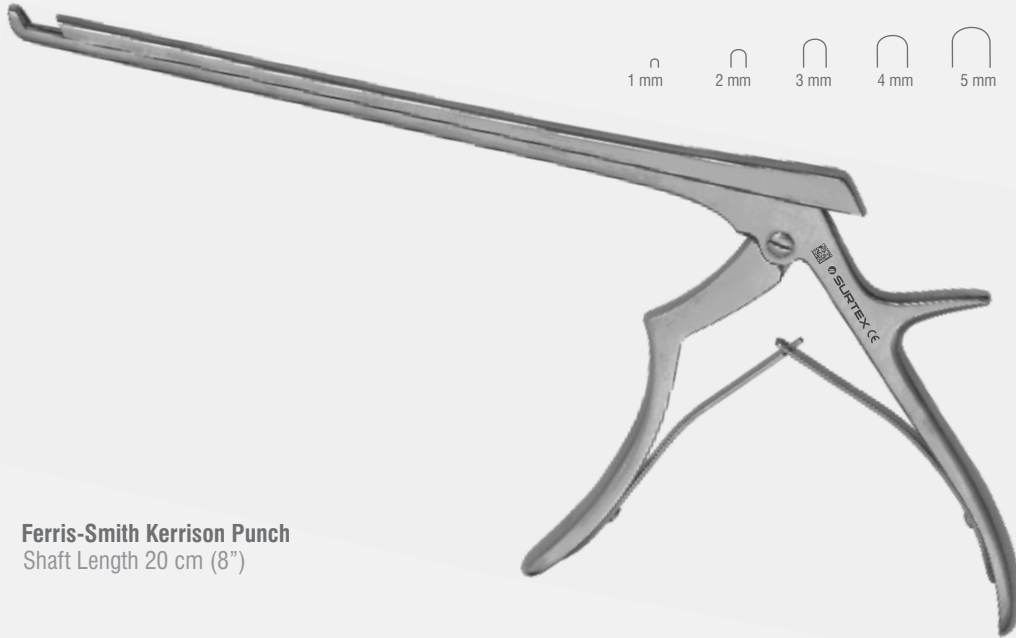

**Ferris-Smith Kerrison Punch**  
Shaft Length 18 cm (7")

Up Cutting		Down Cutting		40° Forward Up Cutting (40°/ 130°)		40° Forward Down Cutting	
<b>NS-304-01</b> 1.0 mm Regular	<b>NS-304-01 T</b> 1.0 mm Thin Footplate	<b>NS-305-01</b> 1.0 mm Regular	<b>NS-305-01 T</b> 1.0 mm Thin Footplate	<b>NS-306-01</b> 1.0 mm Regular	<b>NS-306-01 T</b> 1.0 mm Thin Footplate	<b>NS-307-01</b> 1.0 mm Regular	<b>NS-307-01 T</b> 1.0 mm Thin Footplate
<b>NS-304-02</b> 2.0 mm Regular	<b>NS-304-02 T</b> 2.0 mm Thin Footplate	<b>NS-305-02</b> 2.0 mm Regular	<b>NS-305-02 T</b> 2.0 mm Thin Footplate	<b>NS-306-02</b> 2.0 mm Regular	<b>NS-306-02 T</b> 2.0 mm Thin Footplate	<b>NS-307-02</b> 2.0 mm Regular	<b>NS-307-02 T</b> 2.0 mm Thin Footplate
<b>NS-304-03</b> 3.0 mm Regular	<b>NS-304-03 T</b> 3.0 mm Thin Footplate	<b>NS-305-03</b> 3.0 mm Regular	<b>NS-305-03 T</b> 3.0 mm Thin Footplate	<b>NS-306-03</b> 3.0 mm Regular	<b>NS-306-03 T</b> 3.0 mm Thin Footplate	<b>NS-307-03</b> 3.0 mm Regular	<b>NS-307-03 T</b> 3.0 mm Thin Footplate
<b>NS-304-04</b> 4.0 mm Regular	<b>NS-304-04 T</b> 4.0 mm Thin Footplate	<b>NS-305-04</b> 4.0 mm Regular	<b>NS-305-04 T</b> 4.0 mm Thin Footplate	<b>NS-306-04</b> 4.0 mm Regular	<b>NS-306-04 T</b> 4.0 mm Thin Footplate	<b>NS-307-04</b> 4.0 mm Regular	<b>NS-307-04 T</b> 4.0 mm Thin Footplate
<b>NS-304-05</b> 5.0 mm Regular	<b>NS-304-05 T</b> 5.0 mm Thin Footplate	<b>NS-305-05</b> 5.0 mm Regular	<b>NS-305-05 T</b> 5.0 mm Thin Footplate	<b>NS-306-05</b> 5.0 mm Regular	<b>NS-306-05 T</b> 5.0 mm Thin Footplate	<b>NS-307-05</b> 5.0 mm Regular	<b>NS-307-05 T</b> 5.0 mm Thin Footplate

Laminectomy Punches  
Laminektomiestanzen  
Pinzas cortantes para laminectomia  
Pincas emporte-pièces à laminectomie  
Pinze taglianti per laminectomia



**Ferris-Smith Kerrison Punch**  
Shaft Length 20 cm (8")

 Up Cutting	 Down Cutting	 40° Forward Up Cutting (40°/ 130°)	 40° Forward Down Cutting				
<b>NS-308-01</b> 1.0 mm Regular	<b>NS-308-01 T</b> 1.0 mm Thin Footplate	<b>NS-309-01</b> 1.0 mm Regular	<b>NS-309-01 T</b> 1.0 mm Thin Footplate	<b>NS-310-01</b> 1.0 mm Regular	<b>NS-310-01 T</b> 1.0 mm Thin Footplate	<b>NS-311-01</b> 1.0 mm Regular	<b>NS-311-01 T</b> 1.0 mm Thin Footplate
<b>NS-308-02</b> 2.0 mm Regular	<b>NS-308-02 T</b> 2.0 mm Thin Footplate	<b>NS-309-02</b> 2.0 mm Regular	<b>NS-309-02 T</b> 2.0 mm Thin Footplate	<b>NS-310-02</b> 2.0 mm Regular	<b>NS-310-02 T</b> 2.0 mm Thin Footplate	<b>NS-311-02</b> 2.0 mm Regular	<b>NS-311-02 T</b> 2.0 mm Thin Footplate
<b>NS-308-03</b> 3.0 mm Regular	<b>NS-308-03 T</b> 3.0 mm Thin Footplate	<b>NS-309-03</b> 3.0 mm Regular	<b>NS-309-03 T</b> 3.0 mm Thin Footplate	<b>NS-310-03</b> 3.0 mm Regular	<b>NS-310-03 T</b> 3.0 mm Thin Footplate	<b>NS-311-03</b> 3.0 mm Regular	<b>NS-311-03 T</b> 3.0 mm Thin Footplate
<b>NS-308-04</b> 4.0 mm Regular	<b>NS-308-04 T</b> 4.0 mm Thin Footplate	<b>NS-309-04</b> 4.0 mm Regular	<b>NS-309-04 T</b> 4.0 mm Thin Footplate	<b>NS-310-04</b> 4.0 mm Regular	<b>NS-310-04 T</b> 4.0 mm Thin Footplate	<b>NS-311-04</b> 4.0 mm Regular	<b>NS-311-04 T</b> 4.0 mm Thin Footplate
<b>NS-308-05</b> 5.0 mm Regular	<b>NS-308-05 T</b> 5.0 mm Thin Footplate	<b>NS-309-05</b> 5.0 mm Regular	<b>NS-309-05 T</b> 5.0 mm Thin Footplate	<b>NS-310-05</b> 5.0 mm Regular	<b>NS-310-05 T</b> 5.0 mm Thin Footplate	<b>NS-311-05</b> 5.0 mm Regular	<b>NS-311-05 T</b> 5.0 mm Thin Footplate

Laminectomy Punches  
Laminektomiestanzen  
Pinzas cortantes para laminectomía  
Pinces emporte-pièces à laminectomie  
Pinze taglienti per laminectomia

NS

NEUROSURGERY



**Ferris-Smith Kerrison Punch**  
Detachable Model  
Shaft Length 18 cm (7")



**NS-320-01**  
1.0 mm

**NS-320-02**  
2.0 mm

**NS-320-03**  
3.0 mm

**NS-320-04**  
4.0 mm

**NS-320-05**  
5.0 mm

**NS-321-01**  
1.0 mm

**NS-321-02**  
2.0 mm

**NS-321-03**  
3.0 mm

**NS-321-04**  
4.0 mm

**NS-321-05**  
5.0 mm

**NS-322-01**  
1.0 mm

**NS-322-02**  
2.0 mm

**NS-322-03**  
3.0 mm

**NS-322-04**  
4.0 mm

**NS-322-05**  
5.0 mm

**NS-323-01**  
1.0 mm

**NS-323-02**  
2.0 mm

**NS-323-03**  
3.0 mm

**NS-323-04**  
4.0 mm

**NS-323-05**  
5.0 mm

Laminectomy Punches  
Laminektomiestanzen  
Pinzas cortantes para laminectomia  
Pinces emporte-pièces à laminectomie  
Pinze taglianti per laminectomia



**Ferris-Smith Kerrison Punch**  
Thin Footplate, Detachable Model  
Shaft Length 18 cm (7")

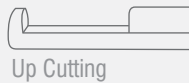

Up Cutting



Down Cutting



40° Forward  
Up Cutting (40°/ 130°)



40° Forward  
Down Cutting

**NS-320-01 T**  
1.0 mm

**NS-320-02 T**  
2.0 mm

**NS-320-03 T**  
3.0 mm

**NS-320-04 T**  
4.0 mm

**NS-320-05 T**  
5.0 mm

**NS-321-01 T**  
1.0 mm

**NS-321-02 T**  
2.0 mm

**NS-321-03 T**  
3.0 mm

**NS-321-04 T**  
4.0 mm

**NS-321-05 T**  
5.0 mm

**NS-322-01 T**  
1.0 mm

**NS-322-02 T**  
2.0 mm

**NS-322-03 T**  
3.0 mm

**NS-322-04 T**  
4.0 mm

**NS-322-05 T**  
5.0 mm

**NS-323-01 T**  
1.0 mm

**NS-323-02 T**  
2.0 mm

**NS-323-03 T**  
3.0 mm

**NS-323-04 T**  
4.0 mm

**NS-323-05 T**  
5.0 mm

Laminectomy Punches  
Laminektomiestanzen  
Pinzas cortantes para laminectomía  
Pincas emporte-pièces à laminectomie  
Pinze taglienti per laminectomia

NS

NEUROSURGERY



**Ferris-Smith Kerrison Punch**  
With Ejector, Detachable Model  
Shaft Length 18 cm (7")



Up Cutting

**NS-320-03 E**  
3.0 mm

**NS-320-04 E**  
4.0 mm

**NS-320-05 E**  
5.0 mm



Down Cutting

**NS-321-03 E**  
3.0 mm

**NS-321-04 E**  
4.0 mm

**NS-321-05 E**  
5.0 mm



40° Forward  
Up Cutting (40°/ 130°)

**NS-322-03 E**  
3.0 mm

**NS-322-04 E**  
4.0 mm

**NS-322-05 E**  
5.0 mm



40° Forward  
Down Cutting

**NS-323-03 E**  
3.0 mm

**NS-323-04 E**  
4.0 mm

**NS-323-05 E**  
5.0 mm

Laminectomy Punches  
Laminektomiestanzen  
Pinzas cortantes para laminectomia  
Pincas emporte-pièces à laminectomie  
Pinze taglianti per laminectomia



**Ferris-Smith Kerrison Punch**  
Thin Footplate With Ejector, Detachable Model  
Shaft Length 18 cm (7")



Up Cutting

**NS-320-03 TE**  
3.0 mm

**NS-320-04 TE**  
4.0 mm

**NS-320-05 TE**  
5.0 mm



Down Cutting

**NS-321-03 TE**  
3.0 mm

**NS-321-04 TE**  
4.0 mm

**NS-321-05 TE**  
5.0 mm



40° Forward  
Up Cutting (40°/ 130°)

**NS-322-03 TE**  
3.0 mm

**NS-322-04 TE**  
4.0 mm

**NS-322-05 TE**  
5.0 mm



40° Forward  
Down Cutting

**NS-323-03 TE**  
3.0 mm

**NS-323-04 TE**  
4.0 mm

**NS-323-05 TE**  
5.0 mm



Laminectomy Punches  
Laminektomiestanzen  
Pinzas cortantes para laminectomía  
Pinces emporte-pièces à laminectomie  
Pinze taglienti per laminectomia

NS

NEUROSURGERY



**Ferris-Smith Kerrison Punch**  
Detachable Model  
Shaft Length 20 cm (8")

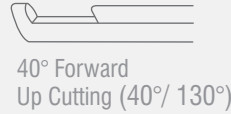

**NS-324-01**  
1.0 mm

**NS-324-02**  
2.0 mm

**NS-324-03**  
3.0 mm

**NS-324-04**  
4.0 mm

**NS-324-05**  
5.0 mm

**NS-325-01**  
1.0 mm

**NS-325-02**  
2.0 mm

**NS-325-03**  
3.0 mm

**NS-325-04**  
4.0 mm

**NS-325-05**  
5.0 mm

**NS-326-01**  
1.0 mm

**NS-326-02**  
2.0 mm

**NS-326-03**  
3.0 mm

**NS-326-04**  
4.0 mm

**NS-326-05**  
5.0 mm

**NS-327-01**  
1.0 mm

**NS-327-02**  
2.0 mm

**NS-327-03**  
3.0 mm

**NS-327-04**  
4.0 mm

**NS-327-05**  
5.0 mm

Laminectomy Punches  
Laminektomiestanzen  
Pinzas cortantes para laminectomia  
Pinces emporte-pièces à laminectomie  
Pinze taglianti per laminectomia



**Ferris-Smith Kerrison Punch**  
With Ejector, Detachable Model  
Shaft Length 20 cm (8")

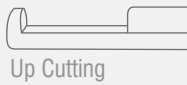

Up Cutting

**NS-324-03 E**

3.0 mm

**NS-324-04 E**

4.0 mm

**NS-324-05 E**

5.0 mm



Down Cutting

**NS-325-03 E**

3.0 mm

**NS-325-04 E**

4.0 mm

**NS-325-05 E**

5.0 mm



40° Forward  
Up Cutting (40°/ 130°)

**NS-326-03 E**

3.0 mm

**NS-326-04 E**

4.0 mm

**NS-326-05 E**

5.0 mm



40° Forward  
Down Cutting

**NS-327-03 E**

3.0 mm

**NS-327-04 E**

4.0 mm

**NS-327-05 E**

5.0 mm

Laminectomy Punches  
Laminektomiestanzen  
Pinzas cortantes para laminectomía  
Pincas emporte-pièces à laminectomie  
Pinze taglienti per laminectomia

NS

NEUROSURGERY



**Ferris-Smith Kerrison Punch**  
Thin Footplate, Detachable Model  
Shaft Length 20 cm (8")



**NS-324-01 T**  
1.0 mm

**NS-324-02 T**  
2.0 mm

**NS-324-03 T**  
3.0 mm

**NS-324-04 T**  
4.0 mm

**NS-324-05 T**  
5.0 mm



**NS-325-01 T**  
1.0 mm

**NS-325-02 T**  
2.0 mm

**NS-325-03 T**  
3.0 mm

**NS-325-04 T**  
4.0 mm

**NS-325-05 T**  
5.0 mm



**NS-326-01 T**  
1.0 mm

**NS-326-02 T**  
2.0 mm

**NS-326-03 T**  
3.0 mm

**NS-326-04 T**  
4.0 mm

**NS-326-05 T**  
5.0 mm



**NS-327-01 T**  
1.0 mm

**NS-327-02 T**  
2.0 mm

**NS-327-03 T**  
3.0 mm

**NS-327-04 T**  
4.0 mm

**NS-327-05 T**  
5.0 mm

Laminectomy Punches  
Laminektomiestanzen  
Pinzas cortantes para laminectomia  
Pinces emporte-pièces à laminectomie  
Pinze taglianti per laminectomia



**Ferris-Smith Kerrison Punch**  
Thin Footplate With Ejector, Detachable Model  
Shaft Length 20 cm (8")



Up Cutting

**NS-324-03 TE**  
3.0 mm

**NS-324-04 TE**  
4.0 mm

**NS-324-05 TE**  
5.0 mm



Down Cutting

**NS-325-03 TE**  
3.0 mm

**NS-325-04 TE**  
4.0 mm

**NS-325-05 TE**  
5.0 mm



40° Forward  
Up Cutting (40°/ 130°)

**NS-326-03 TE**  
3.0 mm

**NS-326-04 TE**  
4.0 mm

**NS-326-05 TE**  
5.0 mm



40° Forward  
Down Cutting

**NS-327-03 TE**  
3.0 mm

**NS-327-04 TE**  
4.0 mm

**NS-327-05 TE**  
5.0 mm

Rongeurs  
Rongeur  
Pinzas cortantes  
Rongeurs  
Pinze per afferrare

NS

NEUROSURGERY



**Cushing Laminectomy Rongeur**

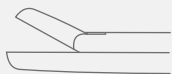

**NS-400-01**  
Straight  
2 x 10 mm



**NS-400-02**  
Up  
2 x 10 mm



**NS-400-03**  
Down  
2 x 10 mm

Shaft Length 13 cm (5")

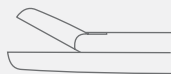

**NS-401-01**  
Straight  
2 x 10 mm



**NS-401-02**  
Up  
2 x 10 mm



**NS-401-03**  
Down  
2 x 10 mm

Shaft Length 15 cm (6")

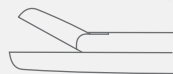

**NS-402-01**  
Straight  
2 x 10 mm



**NS-402-02**  
Up  
2 x 10 mm



**NS-402-03**  
Down  
2 x 10 mm

Shaft Length 18 cm (7")

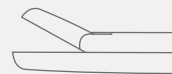

**NS-403-01**  
Straight  
2 x 10 mm



**NS-403-02**  
Up  
2 x 10 mm



**NS-403-03**  
Down  
2 x 10 mm

Shaft Length 20 cm (8")



Rongeurs  
Rongeur  
Pinzas cortantes  
Rongeurs  
Pinze per afferrare



**Love-Gruenwald Laminectomy Rongeur**

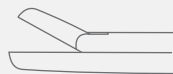

**NS-404-01**  
Straight  
3 x 10 mm

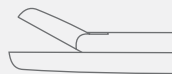

**NS-405-01**  
Straight  
3 x 10 mm

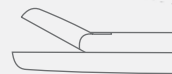

**NS-406-01**  
Straight  
3 x 10 mm

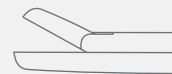

**NS-407-01**  
Straight  
3 x 10 mm



**NS-404-02**  
Up  
3 x 10 mm



**NS-405-02**  
Up  
3 x 10 mm



**NS-406-02**  
Up  
3 x 10 mm



**NS-407-02**  
Up  
3 x 10 mm



**NS-404-03**  
Down  
3 x 10 mm



**NS-405-03**  
Down  
3 x 10 mm



**NS-406-03**  
Down  
3 x 10 mm



**NS-407-03**  
Down  
3 x 10 mm

Shaft Length 13 cm (5")

Shaft Length 15 cm (6")

Shaft Length 18 cm (7")

Shaft Length 20 cm (8")

Rongeurs  
Rongeur  
Pinzas cortantes  
Rongeurs  
Pinze per afferrare

NS

NEUROSURGERY



**Spurling Laminectomy Rongeur**

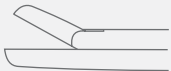

**NS-408-01**  
Straight  
4 x 10 mm

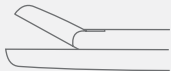

**NS-409-01**  
Straight  
4 x 10 mm

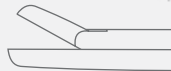

**NS-410-01**  
Straight  
4 x 10 mm

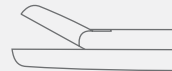

**NS-411-01**  
Straight  
4 x 10 mm



**NS-408-02**  
Up  
4 x 10 mm



**NS-409-02**  
Up  
4 x 10 mm



**NS-410-02**  
Up  
4 x 10 mm



**NS-411-02**  
Up  
4 x 10 mm



**NS-408-03**  
Down  
4 x 10 mm



**NS-409-03**  
Down  
4 x 10 mm



**NS-410-03**  
Down  
4 x 10 mm



**NS-411-03**  
Down  
4 x 10 mm

Shaft Length 13 cm (5")

Shaft Length 15 cm (6")

Shaft Length 18 cm (7")

Shaft Length 20 cm (8")



Rongeurs  
Rongeur  
Pinzas cortantes  
Rongeurs  
Pinze per afferrare



**Caspar Laminectomy Rongeur**  
Fenestrated and Serrated Jaws  
Shaft Length 18 cm (7")



**NS-440-01**  
Straight  
2 x 12 mm



**NS-441-01**  
Straight  
3 x 12 mm



**NS-442-01**  
Straight  
4 x 14 mm



**NS-443-01**  
Straight  
5 x 14 mm



**NS-444-01**  
Straight  
6 x 14 mm



**NS-440-02**  
Up  
2 x 12 mm



**NS-441-02**  
Up  
3 x 12 mm



**NS-442-02**  
Up  
4 x 14 mm



**NS-443-02**  
Up  
5 x 14 mm



**NS-444-02**  
Up  
6 x 14 mm



**NS-440-03**  
Down  
2 x 12 mm



**NS-441-03**  
Down  
3 x 12 mm



**NS-442-03**  
Down  
4 x 14 mm



**NS-443-03**  
Down  
5 x 14 mm



**NS-444-03**  
Down  
6 x 14 mm



Laminektomieezangen  
Laminectomy Rongeurs  
Pinzas para laminectomía  
Pincas pour laminectomie  
Pinze per laminectomia

NS

NEUROSURGERY



**Schlesinger Laminectomy Rongeur**  
Serrated Jaws  
Shaft Length 13 cm (5")



**NS-451-02**  
2 x 10 mm



**NS-451-03**  
3 x 10 mm



**NS-451-04**  
4 x 10 mm



**NS-461-22**  
Ø 2.2 mm

**NS-461-35**  
Ø 3.5 mm

**NS-461-50**  
Ø 5.0 mm

**Yasargil Tumor Grasping Forcep**  
Shaft Length 20 cm (8")



**NS-463-60**  
**Oldberg Tumor Grasping Forcep**  
Ø 6.5 mm  
Shaft Length 18 cm (7")



Laminektomieezangen  
Laminectomy Rongeurs  
Pinzas para laminectomia  
Pincas pour laminectomie  
Pinze per laminectomia



**NS-465-90**  
**Landolt Tumor Grasping Forcep**  
Ø 9.0 mm  
Shaft Length 21 cm (8 ¼")

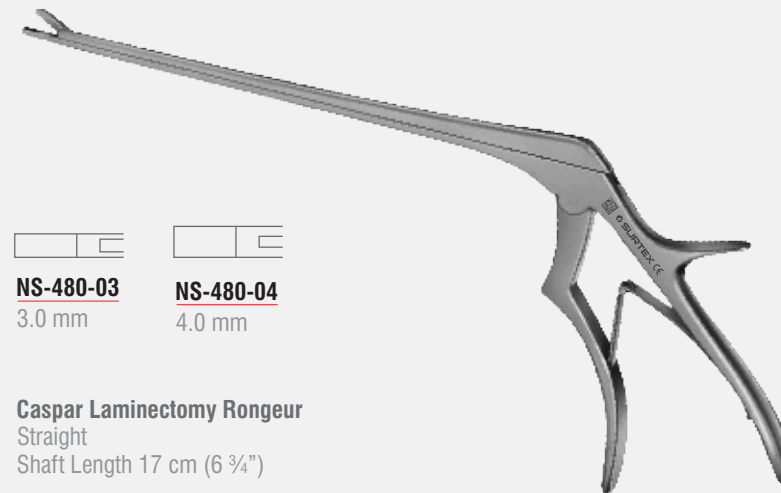

**NS-480-03**  
3.0 mm

**NS-480-04**  
4.0 mm

**Caspar Laminectomy Rongeur**  
Straight  
Shaft Length 17 cm (6 ¾")

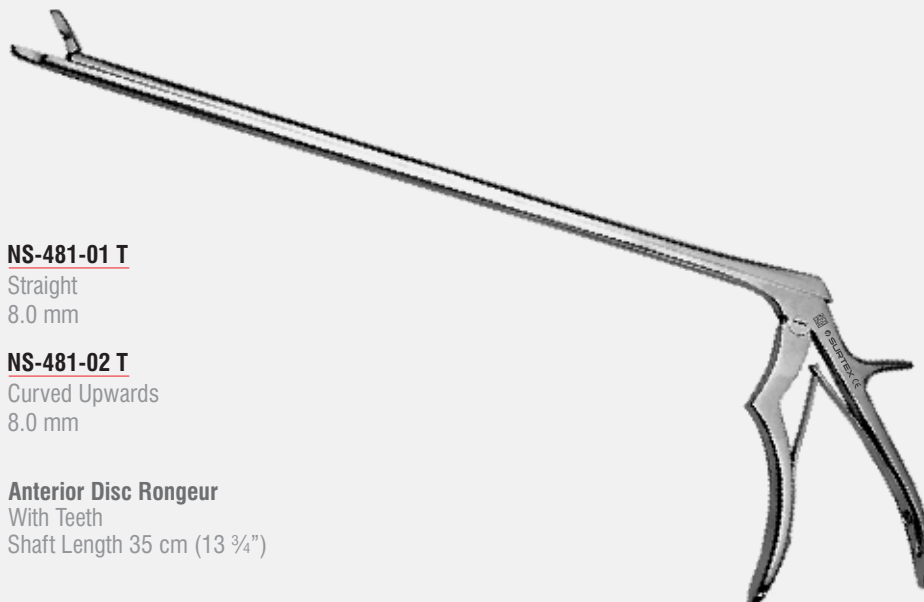

**NS-481-01 T**  
Straight  
8.0 mm

**NS-481-02 T**  
Curved Upwards  
8.0 mm

**Anterior Disc Rongeur**  
With Teeth  
Shaft Length 35 cm (13 ¾")

Laminektomieezangen  
Laminectomy Rongeurs  
Pinzas para laminectomia  
Pinces pour laminectomie  
Pinze per laminectomia

NS

NEUROSURGERY

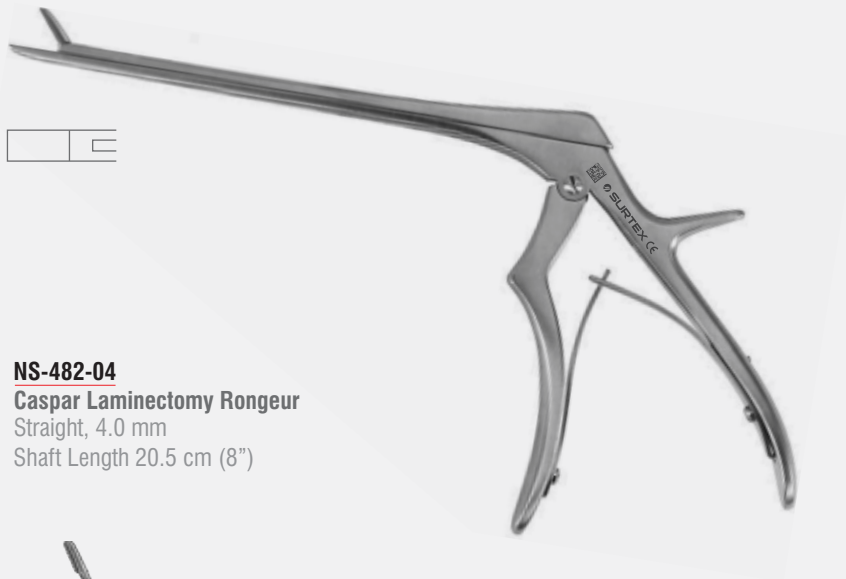

**NS-482-04**  
**Caspar Laminectomy Rongeur**  
Straight, 4.0 mm  
Shaft Length 20.5 cm (8")



**NS-484-05**  
**Wagner Laminectomy Rongeur**  
Straight, 5.5 mm  
Shaft Length 20.5 cm (8")



**NS-488-05**  
**Wagner Laminectomy Rongeur**  
Straight, 5.5 mm  
Shaft Length 20.5 cm (8")



Rongeurs  
Rongeur  
Pinzas cortantes  
Rongeurs  
Pinze per afferrare



**NS-492-02**  
**Sypert Laminectomy Rongeur**  
Curved Upwards, 5.8 mm  
Shaft Length 25 cm (10")

Microdissectomy Curettes  
 Mikrodisektomie-Küretten  
 Curetas para microdissectomía  
 Curettes de microdissectomie  
 Curette per microdissectomia

NS

NEUROSURGERY



<p><b>NS-501-01</b>                      Angled Forward                      Straight Tip, Fig. 1                      21.5 cm (8 ½")</p>	<p><b>NS-501-01 L</b>                      Angled Forward                      Straight Tip, Fig. 1                      24 cm (9 ½")</p>	<p><b>NS-501-02</b>                      Angled Forward                      Straight Tip, Fig. 2                      21.5 cm (8 ½")</p>	<p><b>NS-501-02 L</b>                      Angled Forward                      Straight Tip, Fig. 2                      24 cm (9 ½")</p>
<p><b>NS-501-03</b>                      Angled Forward                      Straight Tip, Fig. 3                      21.5 cm (8 ½")</p>	<p><b>NS-501-03 L</b>                      Angled Forward                      Straight Tip, Fig. 3                      24 cm (9 ½")</p>	<p><b>NS-501-04</b>                      Angled Forward                      Straight Tip, Fig. 4                      21.5 cm (8 ½")</p>	<p><b>NS-501-04 L</b>                      Angled Forward                      Straight Tip, Fig. 4                      24 cm (9 ½")</p>
<p><b>NS-503-01</b>                      Angled Forward                      Curved Tip, Fig. 1                      21.5 cm (8 ½")</p>	<p><b>NS-503-01 L</b>                      Angled Forward                      Curved Tip, Fig. 1                      24 cm (9 ½")</p>	<p><b>NS-503-02</b>                      Angled Forward                      Curved Tip, Fig. 2                      21.5 cm (8 ½")</p>	<p><b>NS-503-02 L</b>                      Angled Forward                      Curved Tip, Fig. 2                      24 cm (9 ½")</p>
<p><b>NS-503-03</b>                      Angled Forward                      Curved Tip, Fig. 3                      21.5 cm (8 ½")</p>	<p><b>NS-503-03 L</b>                      Angled Forward                      Curved Tip, Fig. 3                      24 cm (9 ½")</p>	<p><b>NS-503-04</b>                      Angled Forward                      Curved Tip, Fig. 4                      21.5 cm (8 ½")</p>	<p><b>NS-503-04 L</b>                      Angled Forward                      Curved Tip, Fig. 4                      24 cm (9 ½")</p>
<p><b>NS-505-01</b>                      Angled Backward                      Straight Tip, Fig. 1                      21.5 cm (8 ½")</p>	<p><b>NS-505-01 L</b>                      Angled Backward                      Straight Tip, Fig. 1                      24 cm (9 ½")</p>	<p><b>NS-505-02</b>                      Angled Backward                      Straight Tip, Fig. 2                      21.5 cm (8 ½")</p>	<p><b>NS-505-02 L</b>                      Angled Backward                      Straight Tip, Fig. 2                      24 cm (9 ½")</p>
<p><b>NS-505-03</b>                      Angled Backward                      Straight Tip, Fig. 3                      21.5 cm (8 ½")</p>	<p><b>NS-505-03 L</b>                      Angled Backward                      Straight Tip, Fig. 3                      24 cm (9 ½")</p>	<p><b>NS-505-04</b>                      Angled Backward                      Straight Tip, Fig. 4                      21.5 cm (8 ½")</p>	<p><b>NS-505-04 L</b>                      Angled Backward                      Straight Tip, Fig. 4                      24 cm (9 ½")</p>
<p><b>NS-507-01</b>                      Angled Backward                      Curved Tip, Fig. 1                      21.5 cm (8 ½")</p>	<p><b>NS-507-01 L</b>                      Angled Backward                      Curved Tip, Fig. 1                      24 cm (9 ½")</p>	<p><b>NS-507-02</b>                      Angled Backward                      Curved Tip, Fig. 2                      21.5 cm (8 ½")</p>	<p><b>NS-507-02 L</b>                      Angled Backward                      Curved Tip, Fig. 2                      24 cm (9 ½")</p>
<p><b>NS-507-03</b>                      Angled Backward                      Curved Tip, Fig. 3                      21.5 cm (8 ½")</p>	<p><b>NS-507-03 L</b>                      Angled Backward                      Curved Tip, Fig. 3                      24 cm (9 ½")</p>	<p><b>NS-507-04</b>                      Angled Backward                      Curved Tip, Fig. 4                      21.5 cm (8 ½")</p>	<p><b>NS-507-04 L</b>                      Angled Backward                      Curved Tip, Fig. 4                      24 cm (9 ½")</p>

**Cervical Microdissectomy Curette**  
 Overall Length 24 cm (9 ½")

Microdissectomy Currettes  
Mikrodissektomie-Küretten  
Curetas para microdissectomía  
Currettes de microdissectomie  
Curette per microdissectomia



**Lumbar Microdissectomy Curette**  
Overall Length 24 cm (9 1/2")

**NS-509-00**  
Angled Forward  
Straight Tip, Fig. 0

**NS-515-00**  
Angled Backward  
Straight Tip, Fig. 0

**NS-509-01**  
Angled Forward  
Straight Tip, Fig. 1

**NS-515-01**  
Angled Backward  
Straight Tip, Fig. 1

**NS-509-02**  
Angled Forward  
Straight Tip, Fig. 2

**NS-515-02**  
Angled Backward  
Straight Tip, Fig. 2

**NS-511-00**  
Angled Forward  
Curved Tip, Fig. 0

**NS-517-00**  
Angled Backward  
Curved Tip, Fig. 0

**NS-511-01**  
Angled Forward  
Curved Tip, Fig. 1

**NS-517-01**  
Angled Backward  
Curved Tip, Fig. 1

**NS-511-02**  
Angled Forward  
Curved Tip, Fig. 2

**NS-517-02**  
Angled Backward  
Curved Tip, Fig. 2

**NS-513-00**  
Angled Forward  
Reverse Curved Tip, Fig. 0

**NS-519-00**  
Angled Backward  
Reverse Curved Tip, Fig. 0

**NS-513-01**  
Angled Forward  
Reverse Curved Tip, Fig. 1

**NS-519-01**  
Angled Backward  
Reverse Curved Tip, Fig. 1

**NS-513-02**  
Angled Forward  
Reverse Curved Tip, Fig. 2

**NS-519-02**  
Angled Backward  
Reverse Curved Tip, Fig. 2

Micro Neuro Instruments  
Mikro Neuro Instrumente  
Micro Neuro Instrumentos  
Micro Neuro Instruments  
Micro Neuro Strumenti

NS

NEUROSURGERY



**NS-550-18**  
**Jacobson Micro Knife**  
Straight  
Overall Length 18.5 cm (7 1/4")



**Koos Micro Knife**  
Bayonet Shaped  
Overall Length 18.5 cm (7 1/4")



**NS-555-01**  
Curved  
Upwards



**NS-557-01**  
Curved  
Upwards



**NS-555-02**  
Curved  
Downwards



**NS-557-02**  
Curved  
Downwards



**NS-555-03**  
Curved  
Upwards



**NS-555-04**  
Curved  
Downwards



**Yasargil Micro Knife**  
Bayonet Shaped  
Overall Length 18.5 cm (7 1/4")



**NS-559-01**  
Curved  
Upwards



**NS-559-02**  
Curved  
Downwards

Micro Neuro Instruments  
Mikro Neuro Instrumente  
Micro Neuro Instrumentos  
Micro Neuro Instruments  
Micro Neuro Strumenti



**Yasargil Micro Raspatory**  
Overall Length 18.5 cm (7 1/4")

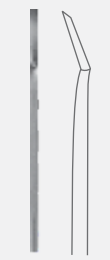

**NS-564-01**  
1.4 mm



**NS-564-02**  
2.6 mm



**NS-564-03**  
4.0 mm



**NS-564-04**  
3.0 mm



**NS-564-05**  
2.6 mm



**Yasargil Micro Raspatory**  
Bayonet Shaped  
Overall Length 18.5 cm (7 1/4")



**NS-565-01**  
Curved  
Downwards  
3.0 mm



**NS-565-02**  
Curved  
Downwards  
3.0 mm



**NS-565-03**  
Curved  
Upwards  
3.0 mm



Micro Neuro Instruments  
Mikro Neuro Instrumente  
Micro Neuro Instrumentos  
Micro Neuro Instruments  
Micro Neuro Strumenti

NS

NEUROSURGERY



**NS-567-18**  
**Yasargil Micro Curette**  
Bayonet Shaped, 1.7 mm  
Overall Length 18.5 cm (7 1/4")



**NS-571-01**  
3.0 mm  
**NS-571-02**  
5.0 mm

**Micro Nerve & Vessel Hook**  
Overall Length 18.5 cm (7 1/4")



**NS-573-01**  
Fig. 1  
0.6 mm / 3.2 mm  
Short Ball Tip

**NS-573-02**  
Fig. 2  
0.8 mm / 3.2 mm  
Long Ball Tip

**NS-573-03**  
Fig. 1  
Ø 0.6 mm / 3.3 mm  
Short Ball Tip

**NS-573-04**  
Fig. 2  
Ø 1.1 mm / 4.5 mm  
Long Ball Tip

**Krayenbuhl Micro Nerve & Vessel Hook**  
Overall Length 18.5 cm (7 1/4")

Micro Neuro Instruments  
Mikro Neuro Instrumente  
Micro Neuro Instrumentos  
Micro Neuro Instruments  
Micro Neuro Strumenti



**Yasargil Ligature Guide**  
Overall Length 18.5 cm (7 1/4")



**NS-575-01**  
Fig. 1  
Ø 1.5 mm



**NS-575-02**  
Fig. 2  
Ø 1.5 mm



**NS-575-03**  
Fig. 3  
Ø 1.5 mm



**NS-575-04**  
Fig. 4  
Ø 1.5 mm



**NS-576-16**  
**Biemer Vessel Spreader**  
Overall Length 16 cm (6 1/4")

Micro Neuro Instruments  
Mikro Neuro Instrumente  
Micro Neuro Instrumentos  
Micro Neuro Instruments  
Micro Neuro Strumenti

NS

NEUROSURGERY



**NS-577-01**  
Fig. 1  
Ø 0.5 mm



**NS-577-02**  
Fig. 2  
Ø 1.0 mm



**NS-577-03**  
Fig. 3  
Ø 1.5 mm

**Micro Vessel Dilator**  
Overall Length 12.5 cm (5")



**Jacobson Micro Vessel Probe**  
Overall Length 18.5 cm (7 1/4")



**NS-579-01**  
1 Prong  
Ø 0.8 mm



**NS-579-02**  
2 Prongs  
Ø 0.8 mm



Micro Neuro Instruments  
Mikro Neuro Instrumente  
Micro Neuro Instrumentos  
Micro Neuro Instruments  
Micro Neuro Strumenti



**NS-579-03**  
**Jacobson Micro Suture Probe**  
Slightly Curved, 2.0 mm  
Overall Length 18.5 cm (7 1/4")



**Caspar Exploration Hook**  
Overall Length 24.5 cm, (9 1/2")



**NS-581-01**  
Fig. 1  
Ø 1.8 mm / 5.0 mm



**NS-581-02**  
Fig. 2  
Ø 2.0 mm / 7.0 mm



**NS-581-03**  
Fig. 3  
Ø 2.5 mm / 9.0 mm



**NS-581-04**  
Fig. 4  
Ø 1.8 mm / 11.0 mm

Micro Neuro Instruments  
Mikro Neuro Instrumente  
Micro Neuro Instrumentos  
Micro Neuro Instruments  
Micro Neuro Strumenti

NS

NEUROSURGERY



**NS-591-01**  
Ø 1.0 mm



**NS-591-02**  
Ø 2.0 mm



**NS-591-03**  
Ø 3.0 mm

Round Shaped



**NS-591-04**  
1.0 mm



**NS-591-05**  
1.5 mm



**NS-591-06**  
2.0 mm

Spatula Shaped

**NS-590-00**  
**Rhoton Micro Dissector**  
Set of 15  
Ref: NS-591-01 up to  
NS-591-15

**Rhoton Micro Dissector**  
Overall Length 18.5 cm (7 ¼")

Micro Neuro Instruments  
Mikro Neuro Instrumente  
Micro Neuro Instrumentos  
Micro Neuro Instruments  
Micro Neuro Strumenti



**NS-591-07**  
1.2 mm



**NS-591-08**  
2.8 mm



**NS-591-09**  
**Rhoton Micro Needle**  
Semi, Sharp  
Overall Length 18.5 cm (7 1/4")



**NS-591-10**  
2.0 mm  
Blunt  
Angled 90°



**NS-591-11**  
2.0 mm  
Semi Sharp  
Angled 90°



**NS-591-12**  
3.0 mm  
Semi Sharp  
Angled 45°

**Rhoton Micro Elevator**  
Overall Length 18.5 cm (7 1/4")

**Rhoton Micro Hook**  
Overall Length 18.5 cm (7 1/4")

Micro Neuro Instruments  
Mikro Neuro Instrumente  
Micro Neuro Instrumentos  
Micro Neuro Instruments  
Micro Neuro Strumenti

NS

NEUROSURGERY



**NS-591-13**  
**Rhoton Micro Probe**  
Angled 90°  
Overall Length 18.5 cm (7 1/4")



**NS-591-14**  
1.0 x 2.0 mm

**NS-591-15**  
Angled 45°  
1.0 x 2.0 mm

**Rhoton Micro Curette**  
Overall Length 18.5 cm (7 1/4")



**NS-601-02**  
**Yasargil Micro Hook**  
Sharp, Curved  
Overall Length 13 cm (5")

Micro Neuro Instruments  
Mikro Neuro Instrumente  
Micro Neuro Instrumentos  
Micro Neuro Instruments  
Micro Neuro Strumenti



**NS-618-24**  
**Yasargil Micro Needle**  
Bayonet Shaped, Semi Sharp  
Overall Length 24 cm (9 1/2")



**NS-631-01**  
Straight  
1.7 mm



**NS-633-01**  
Angled  
1.7 mm



**NS-635-01**  
**Yasargil Micro Curette**  
Curved Downwards  
1.7 mm, Bayonet Shaped  
Overall Length 24 cm (9 1/2")





Micro Neuro Instruments  
Mikro Neuro Instrumente  
Micro Neuro Instrumentos  
Micro Neuro Instruments  
Micro Neuro Strumenti

NS

NEUROSURGERY



**NS-655-24**  
**Hardy Implant Fork**  
Bayonet Shaped  
Overall Length 24 cm (9 1/2")

**Hardy Micro Sickle Dissector**  
Bayonet Shaped  
Overall Length 24 cm (9 1/2")



Micro Neuro Instruments  
Mikro Neuro Instrumente  
Micro Neuro Instrumentos  
Micro Neuro Instruments  
Micro Neuro Strumenti



**Hardy-Fahlbusch Micro Dissector**  
Bayonet Shaped Sharp  
Overall Length 24 cm (9 1/2")



**NS-659-01**  
Curved  
Downwards Sharp



**NS-659-02**  
Curved  
Upwards Sharp



**NS-671-10**  
Straight  
1.0 mm



**NS-671-45**  
Straight  
4.5 mm

**NS-670-00**  
**Caspar Micro Dissector**  
Set of 6  
Overall Length 24 cm (9 1/2")

Micro Neuro Instruments  
Mikro Neuro Instrumente  
Micro Neuro Instrumentos  
Micro Neuro Instruments  
Micro Neuro Strumenti

NS

NEUROSURGERY

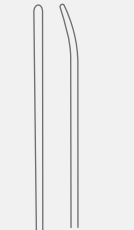

**NS-673-10**  
Curved Down  
1.0 mm



**NS-673-20**  
Curved Down  
2.0 mm

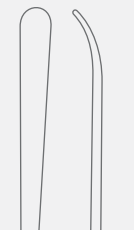

**NS-673-45**  
Curved Down  
4.5 mm



**NS-675-10**  
Curved Up  
1.0 mm



**NS-677-14**  
1.0 mm



**NS-677-20**  
1.4 mm



**NS-677-18**  
1.8 mm

**Caspar Micro Dissector**  
Bayonet Shaped  
Overall Length 24 cm (9 1/2")

**Micro Dissector**  
Semi Sharp Straight Handle  
Overall Length 24 cm (9 1/2")



Micro Neuro Instruments  
Mikro Neuro Instrumente  
Micro Neuro Instrumentos  
Micro Neuro Instruments  
Micro Neuro Strumenti



**Micro Dissector**  
Straight

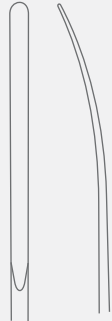

**NS-679-19**  
19 cm (7 1/2")

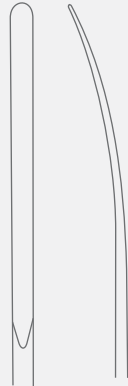

**NS-679-22**  
21.5 cm (8 1/2")



**Ray Micro Curette**  
Overall Length 19 cm (7 1/2")



**NS-680-03**  
Angled 45°  
Horizontal



**NS-680-04**  
Angled 45°  
Horizontal

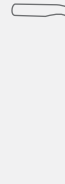

**NS-681-03**  
Angled 90°  
Horizontal



**NS-682-04**  
Angled 45°  
Vertical

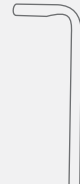

**NS-683-03**  
Angled 90°  
Vertical

Micro Neuro Instruments  
Mikro Neuro Instrumente  
Micro Neuro Instrumentos  
Micro Neuro Instruments  
Micro Neuro Strumenti

NS

NEUROSURGERY



**NS-684-04**  
Curved  
Downwards  
Ø 4.0 mm  
Angled 45°



**NS-684-06**  
Curved  
Downwards  
Ø 6.0 mm  
Angled 45°



**NS-685-04**  
Curved  
Upwards  
Ø 4.0 mm  
Angled 90°



**NS-685-06**  
Curved  
Downward  
Ø 6.0 mm  
Angled 90°



**NS-686-04**  
Curved  
Upwards  
Ø 4.0 mm  
Angled 45°  
Horizontally



**NS-686-06**  
Curved  
Upwards  
Ø 6.0 mm  
Angled 45°  
Horizontally



**NS-687-04**  
Curved  
Upwards  
Ø 4.0 mm  
Angled 90°



**NS-687-06**  
Curved  
Upwards  
Ø 6.0 mm  
Angled 90°

**Hardy Micro Curette**  
Bayonet Shaped  
Overall Length 26 cm (10 1/4")

Micro Neuro Instruments  
Mikro Neuro Instrumente  
Micro Neuro Instrumentos  
Micro Neuro Instruments  
Micro Neuro Strumenti



**Hardy Micro Curette**  
Bayonet Shaped  
Overall Length 24 cm (9 1/2")



**NS-688-01**  
Upwards  
Ø 3.0 mm  
Angled 90°



**NS-688-03**  
Downwards  
Ø 3.0 mm  
Angled 90°



**NS-688-09**  
Right  
Ø 3.0 mm  
Angled 45°



**NS-688-13**  
Curved, Right  
Ø 3.0 mm



**NS-688-02**  
Upwards  
Ø 5.0 mm  
Angled 90°



**NS-688-04**  
Downward  
Ø 5.0 mm  
Angled 90°



**NS-688-10**  
Right  
Ø 5.0 mm  
Angled 45°

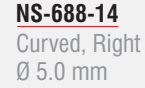

**NS-688-14**  
Curved, Right  
Ø 5.0 mm

Micro Neuro Instruments  
Mikro Neuro Instrumente  
Micro Neuro Instrumentos  
Micro Neuro Instruments  
Micro Neuro Strumenti

NS

NEUROSURGERY



**NS-689-01**

Left  
Ø 6.5 mm



**NS-689-02**

Right  
Ø 6.5 mm



**NS-689-03**

Angled Up, Vertical  
Ø 6.5 mm

**NS-689-04**

Angled Up, Horizontal  
Ø 6.5 mm



**NS-690-21**

**Nicola Micro Raspatory Curved**

Curved Downwards  
Bayonet Shaped  
Overall Length 21.5 cm (8 1/2")

**Nicola Micro Curette**

Bayonet Shaped  
Overall Length 21.5 cm (8 1/2")



Micro Neuro Instruments  
Mikro Neuro Instrumente  
Micro Neuro Instrumentos  
Micro Neuro Instruments  
Micro Neuro Strumenti



**NS-691-10**  
Oval, 1.0 mm

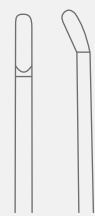

**NS-691-15**  
Oval, 1.5 mm

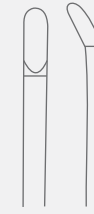

**NS-691-20**  
Oval, 2.0 mm



**NS-691-25**  
Oval, 2.5 mm



**NS-691-30**  
Oval, 3.0 mm



**NS-691-35**  
Oval, 3.5 mm



**NS-691-40**  
Oval, 4.0 mm



**NS-691-50**  
Oval, 5.0 mm

**Samii Tumor Knife**  
Overall Length 23 cm (9")



**NS-693-15**  
Round, 1.5 mm



**NS-693-30**  
Round, 3.0 mm



**NS-693-45**  
Round 4.5 mm



**NS-693-60**  
Round, 6.0 mm

**Samii Tumor Knife**  
Overall Length 23 cm (9")



Micro Neuro Instruments  
Mikro Neuro Instrumente  
Micro Neuro Instrumentos  
Micro Neuro Instruments  
Micro Neuro Strumenti

NS

NEUROSURGERY



**NS-694-18**  
1.8 mm  
23 cm (9")



**NS-694-25**  
1.8 mm  
23 cm (9")

**Samii Lancet Knife**



**NS-695-26**  
**Hosobuchi Fork Spatula**  
Bayonet Shaped, Rigid  
Overall Length 26 cm (10 1/4")

Micro Neuro Instruments  
Mikro Neuro Instrumente  
Micro Neuro Instrumentos  
Micro Neuro Instruments  
Micro Neuro Strumenti



**NS-697-26**  
Landolt Micro Curette



**NS-699-26**  
Landolt Micro Hook  
Blunt



**NS-701-26**  
Landolt Micro Raspatory  
Bayonet Shaped, Malleable  
Overall Length 26 cm (10 1/4")

Bayonet Shaped, Malleable  
Overall Length 26 cm (10 1/4")

Micro Neuro Instruments  
Mikro Neuro Instrumente  
Micro Neuro Instrumentos  
Micro Neuro Instruments  
Micro Neuro Strumenti

NS

NEUROSURGERY

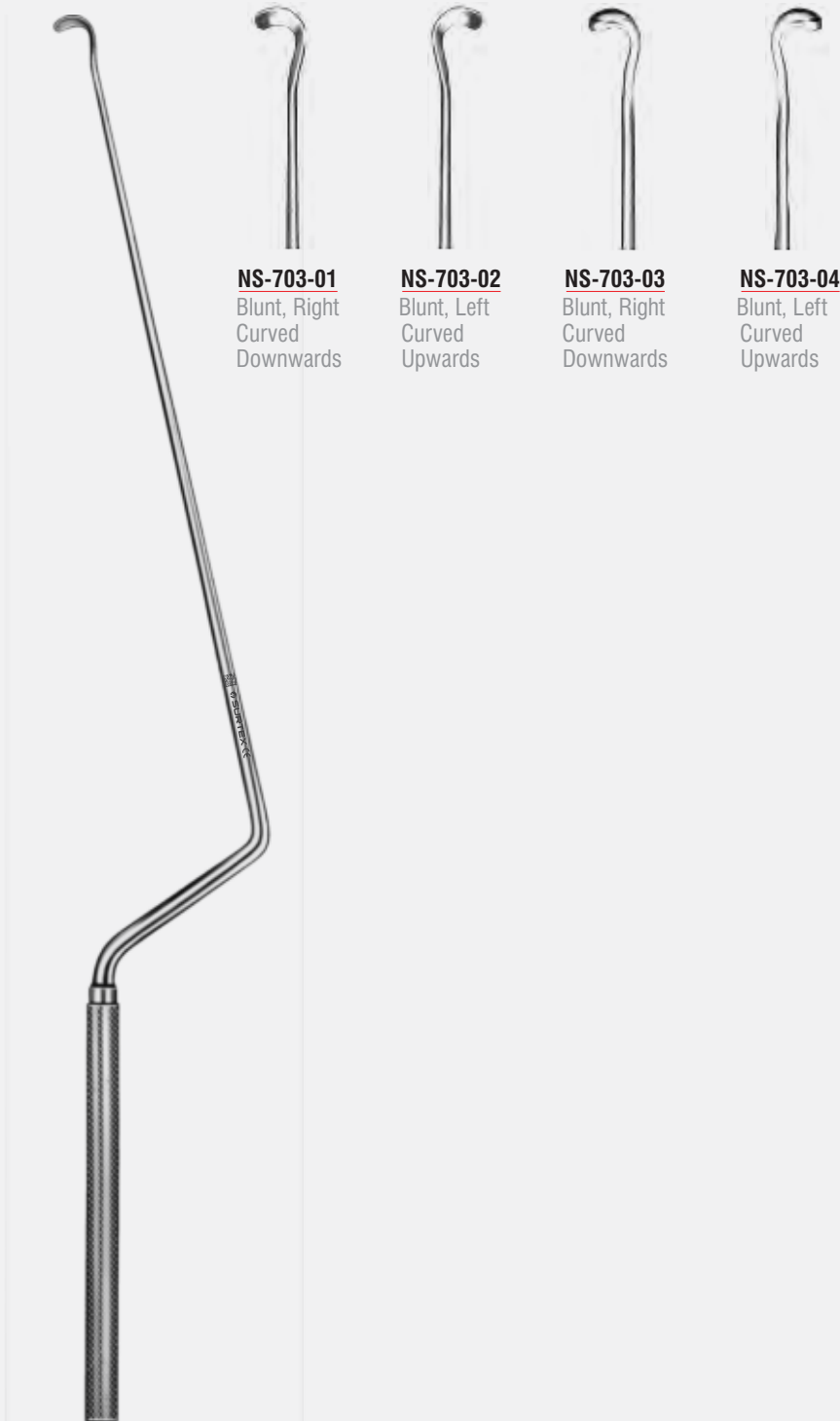

**NS-703-01**  
Blunt, Right  
Curved  
Downwards

**NS-703-02**  
Blunt, Left  
Curved  
Upwards

**NS-703-03**  
Blunt, Right  
Curved  
Downwards

**NS-703-04**  
Blunt, Left  
Curved  
Upwards

**Landolt Micro Enucleator**  
Bayonet Shaped, Malleable, Blunt Tip  
Overall Length 26 cm (10 1/4")

Micro Neuro Instruments  
Mikro Neuro Instrumente  
Micro Neuro Instrumentos  
Micro Neuro Instruments  
Micro Neuro Strumenti



**Landolt-Reulen**  
Rigid, Bayonet Shaped  
Overall Length 26 cm (10 1/4")



**NS-711-26**  
Micro Dissector  
Curved Upwards  
Tip Size Ø 2.0 mm



**NS-713-26**  
Micro Hook  
Blunt  
Tip Size 1.7 mm



**NS-715-26**  
Micro Curette  
Blunt  
Tip Size Ø 2.5 mm



**NS-717-22**  
Micro Raspatory  
Blunt  
Tip Size 2.2 mm



**NS-717-32**  
Micro Raspatory  
Blunt  
Tip Size 3.2 mm

Micro Neuro Instruments  
Mikro Neuro Instrumente  
Micro Neuro Instrumentos  
Micro Neuro Instruments  
Micro Neuro Strumenti

NS

NEUROSURGERY



**NS-719-01**  
2.5 mm  
Spoon



**NS-719-02**  
Ø 2.5 mm  
Curette



**NS-729-08**  
**Micro Ball Probe**  
Bayonet Shaped, Straight Tip  
Ø 0.8 mm  
Overall Length 19.5 cm (7 3/4")



**Micro Dissector**  
Bayonet Shaped  
Overall Length 23 cm (9")



**NS-730-23**  
Straight Shaft  
Blunt Tip



**NS-731-23**  
Curved Upwards  
Blunt Tip



**NS-733-23**  
Curved Downwards  
Blunt Tip



Micro Neuro Instruments  
Mikro Neuro Instrumente  
Micro Neuro Instrumentos  
Micro Neuro Instruments  
Micro Neuro Strumenti



**NS-734-23**  
**Micro Raspatory**  
Straight Shaft, Round Tip  
Overall Length 23 cm (9")



**NS-735-23**  
**Micro Raspatory**  
Curved Upwards, Round Tip  
Bayonet Shaped  
Overall Length 23 cm (9")



**NS-737-01**  
Straight Shaft  
Semi Sharp Tip

**NS-737-02**  
Straight Shaft  
Blunt Tip

**Micro Hook**  
Overall Length 23 cm (9")



**NS-739-01**  
Straight Shaft



**NS-739-02**  
Straight Shaft

**Micro Dissector**  
Overall Length 23 cm (9")

Micro Neuro Instruments  
Mikro Neuro Instrumente  
Micro Neuro Instrumentos  
Micro Neuro Instruments  
Micro Neuro Strumenti

NS

NEUROSURGERY



**Micro Scoop**  
Overall Length 23 cm (9")



**NS-740-01**  
Straight Shaft  
Straight Tip



**NS-740-02**  
Straight Shaft  
Angled Tip



**NS-741-01**  
**Micro Raspatory**  
Straight Shaft Angled Tip  
Overall Length 23 cm (9")



**NS-751-01**  
70 x 15 mm

**NS-751-02**  
90 x 15 mm

**NS-751-03**  
110 x 15 mm

**Cushing-Landolt Specula**



**NS-753-01**  
80 x 11 mm

**NS-753-02**  
90 x 13 mm

**NS-753-03**  
100 x 15 mm

**Papavero-Caspar Specula**

Micro Neuro Instruments  
Mikro Neuro Instrumente  
Micro Neuro Instrumentos  
Micro Neuro Instruments  
Micro Neuro Strumenti



**NS-755-21**  
**Landolt Specula**  
Overall Length 21.5 cm (8 1/2")



Mirror

**NS-790-06**  
Ø 6.0 mm

**NS-790-08**  
Ø 8.0 mm

**NS-790-10**  
Ø 10.0 mm

**NS-790-12**  
Ø 12.0 mm



**NS-792-00**  
**Mirror Handle**  
Bayonet Shaped  
Overall Length 15 cm (6")



Micro Neuro Instruments  
Mikro Neuro Instrumente  
Micro Neuro Instrumentos  
Micro Neuro Instruments  
Micro Neuro Strumenti

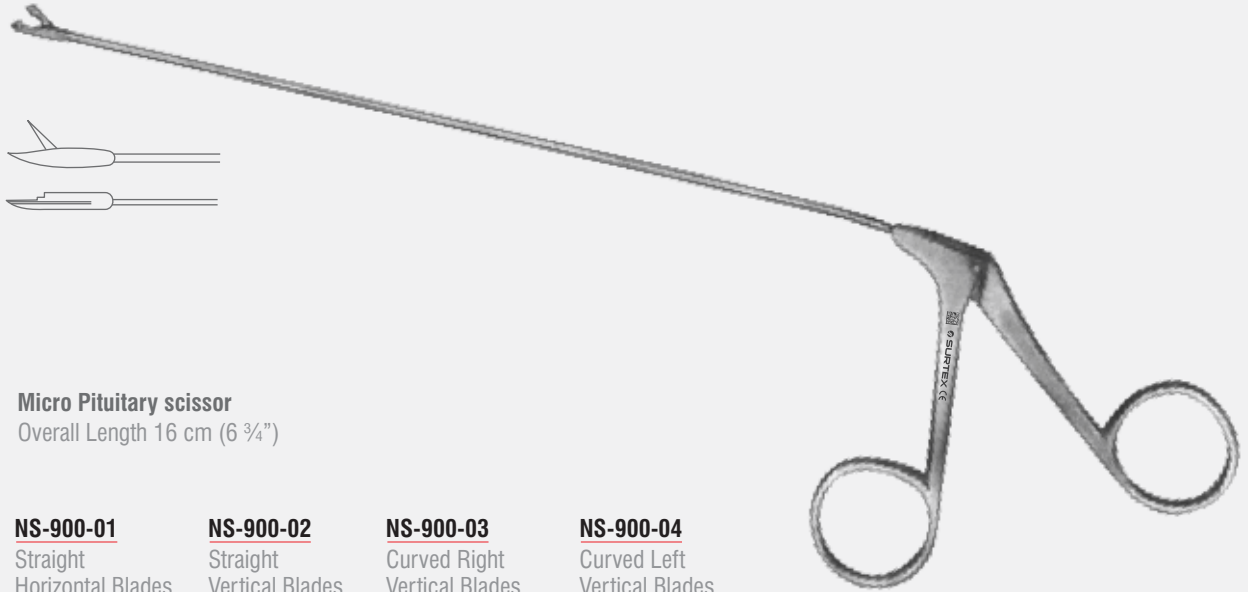

**Micro Pituitary scissor**  
Overall Length 16 cm (6 3/4")

**NS-900-01**  
Straight  
Horizontal Blades

**NS-900-02**  
Straight  
Vertical Blades

**NS-900-03**  
Curved Right  
Vertical Blades

**NS-900-04**  
Curved Left  
Vertical Blades

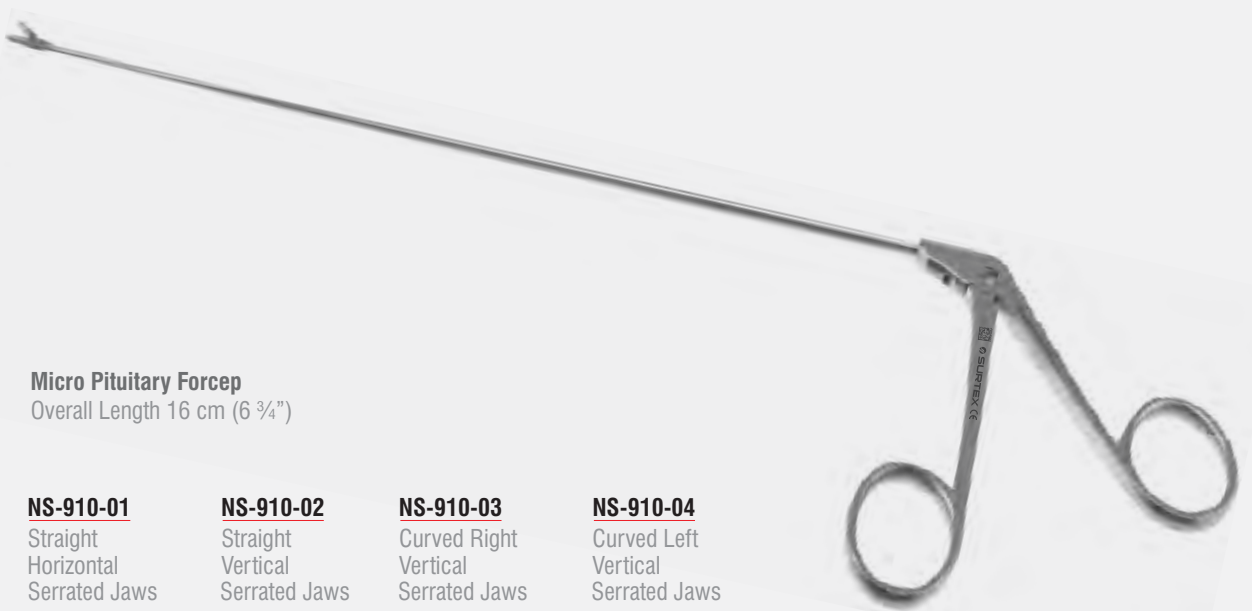

**Micro Pituitary Forcep**  
Overall Length 16 cm (6 3/4")

**NS-910-01**  
Straight  
Horizontal  
Serrated Jaws

**NS-910-02**  
Straight  
Vertical  
Serrated Jaws

**NS-910-03**  
Curved Right  
Vertical  
Serrated Jaws

**NS-910-04**  
Curved Left  
Vertical  
Serrated Jaws

Micro Neuro Instruments  
Mikro Neuro Instrumente  
Micro Neuro Instrumentos  
Micro Neuro Instruments  
Micro Neuro Strumenti

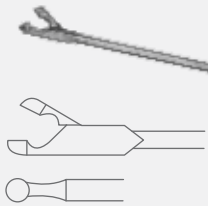

**Micro Pituitary Cup Biopsy Forcep**

Ø 1.0 mm  
Overall Length 16 cm (6 3/4")

**NS-920-01**

Straight  
Horizontal  
Cup Shaped Jaws

**NS-920-02**

Straight  
Vertical  
Cup Shaped Jaws

**NS-920-03**

Curved Right  
Vertical  
Cup Shaped Jaws

**NS-920-04**

Curved Left  
Vertical  
Cup Shaped Jaws

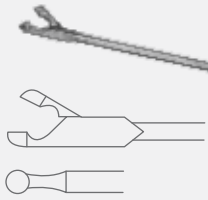
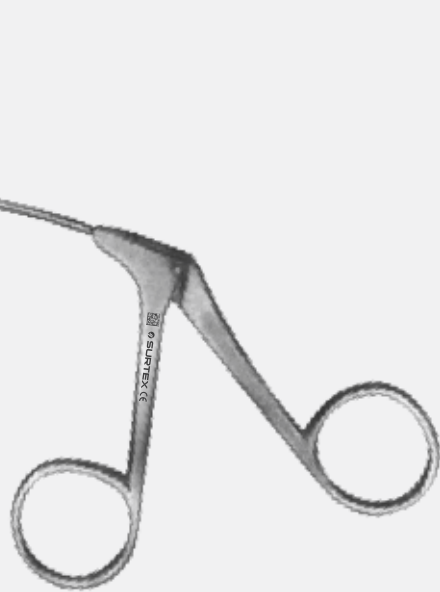

**Micro Pituitary Cup Biopsy Forcep**

Ø 2.0 mm  
Overall Length 16 cm (6 3/4")

**NS-922-01**

Straight  
Horizontal  
Cup Shaped Jaws

**NS-922-02**

Straight  
Vertical  
Cup Shaped Jaws

**NS-922-03**

Curved Right  
Vertical  
Cup Shaped Jaws

**NS-922-04**

Curved Left  
Vertical  
Cup Shaped Jaws

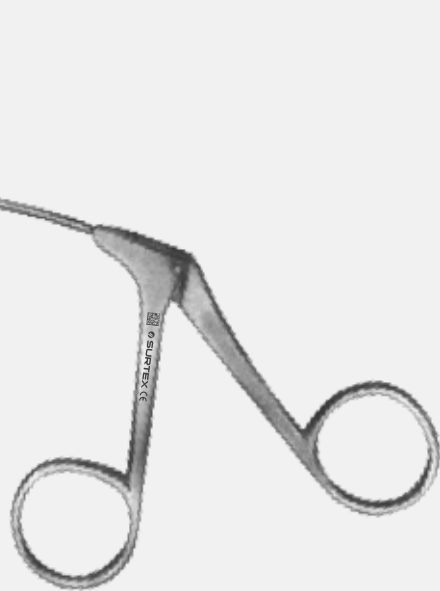



## ALPHABETICAL INDEX



**SURTEX**  
INSTRUMENTS

*Crafted to Excellence*

## Alphabetical Index

### A Pages

Adson Drill Guide & Dura Protector	9
Adson Cranial Rongeur	9
Adson Dura Hook	22

### B Pages

Bacon Cranial Rongeur	9
Biemer Vessel Spreader	49

### C Pages

Cairns Dura Hook	22
Campbell Nerve Root Retractor	20
Caspar Vertebral Distractor	3
Caspar Drill Guide	3
Caspar Twist Drill	4
Caspar Distraction Screw	4
Caspar Screw Driver	4
Caspar Vertebral Body Dissector	5
Caspar Nerve Root Retractor	18
Caspar Laminectomy Rongeur	39
Caspar Laminectomy Rongeur	41
Caspar Laminectomy Rongeur	42
Caspar Exploration Hook	51
Caspar Micro Dissector	57
Caspar Micro Dissector	58
Cervical Microdissectomy Curette	44
Cone Cranial Punch	10
Crutchfield Skull Traction Tongs	7
Crutchfield Drill Point	7
Cushing Brain Spatulas	20
Cushing Laminectomy Rongeur	36
Cushing-Landolt	70

### D Pages

Dahlgren Cranial Rongeur	9
Dandy Nerve Retractor	23
Davis Dura Dissector	12
De-Martel Wire Saw Guide	7
De Vilbiss Cranial Rongeur	9

### F Pages

Ferris-Smith Kerrison Punch	25-35
Frazier Dura Dissector	12
Frazier Dura Hook	23

### G Pages

Gigli Wire Saw	7
Graham Dura Hook	22

### H Pages

Halle Brain Knife	24
Hardy Micro Sickle Dissector	56
Hardy Implant Fork	56
Hardy Micro Curette	60-61

### H Pages

Hardy-Fahlbusch Micro Dissector	57
Heifetz Brain Spatulas	21
Hess Nerve Root Retractor	18
Hoer Nerve Retractor	23
Hoer-dura Dissector	12
Holsher Nerve Root Retractor,	19
Horsley Dura Elevator	16
Hosobuchi Fork Spatula	64

### J Pages

Jacobson Micro Knife	46
Jacobson Micro Vessel Probe	50
Jacobson Micro Suture Probe	51

### K Pages

Krayenbuhl Micro Nerve & Vessel Hook	48
Koos Micro Knife	46

### L Pages

Landolt Tumor Grasping Forcep	41
Landolt Micro Curette	65
Landolt Micro Raspatory	65
Landolt Specula	71
Landolt-Reulen	67
Landolt-Reulen Micro Raspatory	68
Love Nerve Root Retractor	17-18
Love-Adson Dura Dissector	13
Love-Gruenwald Laminectomy Rongeur	37
Lumbar Microdissectomy Curette	45

### M Pages

Markham-Meyerding Hemi-Laminectomy Retractor	6
McKenzie Clip Applying Forcep	10
Meyerding Hemi-Laminectomy Retractor	5
Milligan Dura Dissector	41

### N Pages

Nicola Micro Curette	62
Nicola Micro Raspatory Curved	62

### O Pages

Oldberg Tumor Grasping Forcep	40
Olivecrona Dura Dissector	13-14
Olivecrona Brain Spatulas	20-21
Olivecrona-Toennis Clip Applying Forcep	11

### P Pages

Papavero-Caspar Specula	70
Penfield Dura Dissector	15-16

## Alphabetical Index

### R Pages

Raney Scalp Clip	10
Raney Applying-Removal Forcep	10
Raney Ray Micro Curette	59
Rhoton Micro Dissector	52
Rhoton Micro Elevator,	53
Rhoton Micro Needle	53
Rhoton Micro Hook	53
Rhoton Micro Probe	54
Rhoton Micro Curette	54

### S Pages

Sachs Dura Dissector	14
Sachs Dura Elevator	16
Sachs Dura Hook	22
Sachs samii lancet Knife	64
Sachs Samii tumor Knife	63
Schlesinger Laminectomy Rongeur	40
Scoville Nerve Root Retractor,	19
Smithwick Nerve Hook	22
Smithwick Nerve Retractor	24
Spurling Laminectomy Rongeur	38
Sypert Laminectomy Rongeur	43

### T Pages

Toennis Nerve Retractor	24
Toennis Brain Knife.	24
Toennis Toennis-Dura Dissector	13

### W Pages

Wagner Laminectomy Rongeur	42
Williams Discectomy Retractor	6

### Y Pages

Yasargil Tumor Grasping Forcep	40
Yasargil Micro Knife	46
Yasargil Micro Raspatory	47
Yasargil Micro Curette	48
Yasargil Ligature Guide	49
Yasargil Micro Hook	54
Yasargil Micro Needle	55
Yasargil Micro Curette	55
Yasargil (Leyla) Brain Single Arm Retractor	1
Yasargil (Leyla) Brain Double Arm Retractor	1
Yasargil (Leyla) Flexible Arm	1
Yasargil (Leyla) Fixation Base	2
Yasargil (Leyla) Support For Round Spatulas	2
Yasargil (Leyla) Support For Flat Spatulas	2
Yasargil (Leyla) Ball and Socket Joint	2
Yasargil (Leyla) Holding Rod	2
Yasargil (Leyla) Coupling Head	3
Yasargil-Galea Hook	11

## Numerical Index

Cat. No.	Page	Cat. No.	Page	Cat. No.	Page	Cat. No.	Page
NS-010-01	1	NS-118-00	11	NS-239-18	22	NS-306-02 T	26
NS-010-02	1	NS-120-01	11	NS-241-18	23	NS-306-03	26
NS-010-10	1	NS-120-02	11	NS-245-22	23	NS-306-03 T	26
NS-010-45	1	NS-151-21	12	NS-251-01	23	NS-306-04	26
NS-012-09	1	NS-153-24	12	NS-251-02	23	NS-306-04 T	26
NS-012-20	1	NS-155-01	12	NS-251-03	23	NS-306-05	26
NS-012-25	1	NS-155-02	12	NS-253-29	24	NS-306-05 T	26
NS-012-40	1	NS-155-03	12	NS-261-15	24	NS-307-01	26
NS-010-21	2	NS-157-16	13	NS-280-18	24	NS-307-01 T	26
NS-010-22	2	NS-159-26	13	NS-282-20	24	NS-307-02	26
NS-010-30	2	NS-161-01	13	NS-300-01	25	NS-307-02 T	26
NS-010-40	2	NS-161-02	13	NS-300-01 T	25	NS-307-03	26
NS-012-10	2	NS-161-03	14	NS-300-02	25	NS-307-03 T	26
NS-016-01	3	NS-161-04	14	NS-300-02 T	25	NS-307-04	26
NS-020-02	3	NS-163-21	14	NS-300-03	25	NS-307-04 T	26
NS-022-01	3	NS-165-21	14	NS-300-03 T	25	NS-307-05	26
NS-022-02	3	NS-167-22	15	NS-300-04	25	NS-307-05 T	26
NS-024-00	4	NS-171-01	15	NS-300-04 T	25	AF-246-17	26
NS-026-12	4	NS-171-02	15	NS-300-05	25	NS-308-01	27
NS-026-14	4	NS-171-03	15	NS-300-05 T	25	NS-308-01 T	27
NS-026-16	4	NS-171-04	16	NS-301-01	25	NS-308-02	27
NS-026-18	4	NS-171-05	16	NS-301-01 T	25	NS-308-02 T	27
NS-028-20	4	NS-181-20	16	NS-301-02	25	NS-308-03	27
NS-029-01	5	NS-183-21	16	NS-301-02 T	25	NS-308-03 T	27
NS-029-02	5	NS-190-21	17	NS-301-03	25	NS-308-04	27
NS-031-32	5	NS-191-18	17	NS-301-03 T	25	NS-308-04 T	27
NS-031-44	5	NS-193-11	17	NS-301-04	25	NS-308-05	27
NS-031-54	5	NS-195-21	18	NS-301-04 T	25	NS-308-05 T	27
NS-031-60	5	NS-196-04	18	NS-301-05	25	NS-309-01	27
NS-033-40	6	NS-196-06	18	NS-301-05 T	25	NS-309-01 T	27
NS-033-50	6	NS-196-08	18	NS-302-01	25	NS-309-02	27
NS-033-60	6	NS-196-10	18	NS-302-01 T	25	NS-309-02 T	27
NS-035-40	6	NS-197-03	18	NS-302-02	25	NS-309-03	27
NS-035-50	6	NS-197-05	18	NS-302-02 T	25	NS-309-03 T	27
NS-035-60	6	NS-197-07	18	NS-302-03	25	NS-309-04	27
NS-037-01	6	NS-200-23	19	NS-302-03 T	25	NS-309-04 T	27
NS-037-02	6	NS-201-24	19	NS-302-04	25	NS-309-05	27
NS-037-03	6	NS-203-19	19	NS-302-04 T	25	NS-309-05 T	27
NS-037-04	6	NS-205-21	20	NS-302-05	25	NS-310-01	27
NS-037-05	6	NS-210-07	20	NS-302-05 T	25	NS-310-01 T	27
NS-037-06	6	NS-210-11	20	NS-303-01	25	NS-310-02	27
NS-039-01	6	NS-210-15	20	NS-303-01 T	25	NS-310-02 T	27
NS-039-02	6	NS-210-18	20	NS-303-02	25	NS-310-03	27
NS-039-03	6	NS-213-07	20	NS-303-02 T	25	NS-310-03 T	27
NS-039-04	6	NS-213-11	20	NS-303-03	25	NS-310-04	27
NS-039-05	6	NS-213-15	20	NS-303-03 T	25	NS-310-04 T	27
NS-039-06	6	NS-213-18	20	NS-303-04	25	NS-310-05	27
NS-050-30	7	NS-215-07	21	NS-303-04 T	25	NS-310-05 T	27
NS-050-40	7	NS-215-11	21	NS-303-05	25	NS-311-01	27
NS-050-50	7	NS-215-15	21	NS-303-05 T	25	NS-311-01 T	27
NS-050-60	7	NS-215-18	21	NS-304-01	26	NS-311-02	27
NS-050-70	7	NS-218-07	21	NS-304-01 T	26	NS-311-02 T	27
NS-055-00	7	NS-218-10	21	NS-304-02	26	NS-311-03	27
NS-058-00	7	NS-218-13	21	NS-304-02 T	26	NS-311-03 T	27
NS-061-01	7	NS-218-15	21	NS-304-03	26	NS-311-04	27
NS-061-02	7	NS-218-17	21	NS-304-03 T	26	NS-311-04T	27
NS-065-35	8	NS-218-22	21	NS-304-04	26	NS-311-05	27
NS-065-50	8	NS-221-08	21	NS-304-04 T	26	NS-311-05 T	27
NS-071-00	8	NS-221-11	21	NS-304-05	26	NS-320-01	28
NS-075-01	8	NS-221-14	21	NS-304-05 T	26	NS-320-02	28
NS-075-02	8	NS-221-17	21	NS-305-01	26	NS-320-03	28
NS-081-15	9	NS-221-20	21	NS-305-01 T	26	NS-320-04	28
NS-083-21	9	NS-224-12	21	NS-305-02	26	NS-320-05	28
NS-086-20	9	NS-224-17	21	NS-305-02 T	26	NS-321-01	28
NS-087-20	9	NS-226-13	21	NS-305-03	26	NS-321-02	28
NS-091-20	9	NS-226-17	21	NS-305-03 T	26	NS-321-03	28
NS-093-21	9	NS-231-17	22	NS-305-04	26	NS-321-04	28
NS-095-22	10	NS-233-21	22	NS-305-04 T	26	NS-321-05	28
NS-097-21	10	NS-234-20	22	NS-305-05	26	NS-322-01	28
NS-100-00	10	NS-235-20	22	NS-305-05 T	26	NS-322-02	28
NS-102-00	10	NS-236-01	22	NS-306-01	26	NS-322-03	28
NS-112-19	10	NS-236-02	22	NS-306-01 T	26	NS-322-04	28
NS-115-14	11	NS-237-16	22	NS-306-02	26	NS-322-05	28

## Numerical Index

Cat. No.	Page	Cat. No.	Page	Cat. No.	Page	Cat. No.	Page
NS-323-01	28	NS-327-03 E	33	NS-440-03	39	NS-564-02	47
NS-323-02	28	NS-327-04 E	33	NS-441-01	39	NS-564-03	47
NS-323-03	28	NS-327-05 E	33	NS-441-02	39	NS-564-04	47
NS-323-04	28	NS-324-01 T	34	NS-441-03	39	NS-564-05	47
NS-323-05	28	NS-324-02 T	34	NS-442-01	39	NS-565-01	47
NS-320-01 T	29	NS-324-03 T	34	NS-442-02	39	NS-565-02	47
NS-320-02 T	29	NS-324-04 T	34	NS-442-03	39	NS-565-03	47
NS-320-03 T	29	NS-324-05 T	34	NS-443-01	39	NS-567-18	48
NS-320-04 T	29	NS-325-01 T	34	NS-443-02	39	NS-571-01	48
NS-320-05 T	29	NS-325-02 T	34	NS-443-03	39	NS-571-02	48
NS-321-01 T	29	NS-325-03 T	34	NS-444-01	39	NS-573-01	48
NS-321-02 T	29	NS-325-04 T	34	NS-444-02	39	NS-573-02	48
NS-321-03 T	29	NS-325-05 T	34	NS-444-03	39	NS-573-03	48
NS-321-04 T	29	NS-326-01 T	34	NS-451-02	40	NS-573-04	48
NS-321-05 T	29	NS-326-02 T	34	NS-451-03	40	NS-575-01	49
NS-322-01 T	29	NS-326-03 T	34	NS-451-03	40	NS-575-02	49
NS-322-02 T	29	NS-326-04 T	34	NS-461-22	40	NS-575-03	49
NS-322-03 T	29	NS-326-05 T	34	NS-461-35	40	NS-575-04	49
NS-322-04 T	29	NS-327-01 T	34	NS-461-50	40	NS-576-16	49
NS-322-05 T	29	NS-327-02 T	34	NS-463-60	40	NS-577-01	50
NS-323-01 T	29	NS-327-03 T	34	NS-465-90	41	NS-577-02	50
NS-323-02 T	29	NS-327-04 T	34	NS-480-03	41	NS-577-03	50
NS-323-03 T	29	NS-327-05 T	34	NS-480-04	41	NS-579-01	50
NS-323-04 T	29	NS-324-03 TE	35	NS-481-01	41	NS-579-02	50
NS-323-05 T	29	NS-324-04 TE	35	NS-481-02	41	NS-579-03	51
NS-320-03 E	30	NS-324-05 TE	35	NS-482-04	42	NS-581-01	51
NS-320-04 E	30	NS-325-03 TE	35	NS-484-05	42	NS-581-02	51
NS-320-05 E	30	NS-325-04 TE	35	NS-488-05	42	NS-581-03	51
NS-321-03 E	30	NS-325-05 TE	35	NS-492-02	43	NS-581-04	51
NS-321-04 E	30	NS-326-03 TE	35	NS-501-01	44	NS-590-00	52
NS-321-05 E	30	NS-326-04 TE	35	NS-501-02	44	NS-591-01	52
NS-322-03 E	30	NS-326-05 TE	35	NS-501-03	44	NS-591-02	52
NS-322-04 E	30	NS-327-03 TE	35	NS-501-04	44	NS-591-03	52
NS-322-05 E	30	NS-327-04 TE	35	NS-503-01	44	NS-591-04	52
NS-323-03 E	30	NS-327-05 TE	35	NS-503-02	44	NS-309-05	52
NS-323-04 E	30	NS-400-01	36	NS-503-03	44	NS-591-06	52
NS-323-05 E	30	NS-400-02	36	NS-503-04	44	NS-591-07	53
NS-320-03 TE	31	NS-400-03	36	NS-505-01	44	NS-591-08	53
NS-320-04 TE	31	NS-401-01	36	NS-505-02	44	NS-591-09	53
NS-320-05 TE	31	NS-401-02	36	NS-505-03	44	NS-591-10	53
NS-321-03 TE	31	NS-401-03	36	NS-505-04	44	NS-591-11	53
NS-321-04 TE	31	NS-402-01	36	NS-507-01	44	NS-591-12	53
NS-321-05 TE	31	NS-402-02	36	NS-507-02	44	NS-591-13	54
NS-322-03 TE	31	NS-402-03	36	NS-507-03	44	NS-591-14	54
NS-322-04 TE	31	NS-403-01	36	NS-507-04	44	NS-591-15	54
NS-322-05 TE	31	NS-403-02	36	NS-509-00	45	NS-601-02	54
NS-323-03 TE	31	NS-403-03	36	NS-509-01	45	NS-618-24	55
NS-323-04 TE	31	NS-404-01	37	NS-509-02	45	NS-631-01	55
NS-323-05 TE	31	NS-404-02	37	NS-511-00	45	NS-633-01	55
NS-324-01	32	NS-404-03	37	NS-511-01	45	NS-635-01	55
NS-324-02	32	NS-405-01	37	NS-511-02	45	NS-311-02	56
NS-324-03	32	NS-405-02	37	NS-513-00	45	NS-651-01	56
NS-324-04	32	NS-405-03	37	NS-513-01	45	NS-651-02	56
NS-324-05	32	NS-406-01	37	NS-513-02	45	NS-651-03	56
NS-325-01	32	NS-406-02	37	NS-515-00	45	NS-651-04	56
NS-325-02	32	NS-406-03	37	NS-515-01	45	NS-651-11	56
NS-325-03	32	NS-407-01	37	NS-515-02	45	NS-651-12	56
NS-325-04	32	NS-407-02	37	NS-517-00	45	NS-651-13	56
NS-325-05	32	NS-407-03	37	NS-517-01	45	NS-651-14	56
NS-326-01	32	NS-408-01	38	NS-517-02	45	NS-655-24	56
NS-326-02	32	NS-408-02	38	NS-519-00	45	NS-320-03	57
NS-326-03	32	NS-408-03	38	NS-519-01	45	NS-659-01	57
NS-326-04	32	NS-409-01	38	NS-519-02	45	NS-659-02	57
NS-326-05	32	NS-409-02	38	NS-550-18	46	NS-659-02	57
NS-324-03 E	33	NS-409-03	38	NS-555-01	46	NS-670-00	57
NS-324-04 E	33	NS-410-01	38	NS-555-02	46	NS-671-10	57
NS-324-05 E	33	NS-410-03	38	NS-555-03	46	NS-671-45	57
NS-325-03 E	33	NS-410-03	38	NS-555-04	46	NS-673-10	58
NS-325-04 E	33	NS-411-01	38	NS-557-01	46	NS-673-20	58
NS-325-05 E	33	NS-411-02	38	NS-557-02	46	NS-673-45	58
NS-326-03 E	33	NS-411-03	38	NS-559-01	46	NS-675-10	58
NS-326-04 E	33	NS-440-01	39	NS-559-02	46	NS-677-14	58
NS-326-05 E	33	NS-440-02	39	NS-564-01	47	NS-677-18	58

## Numerical Index

Cat. No.	Page	Cat. No.	Page	Cat. No.	Page	Cat. No.	Page
NS-677-20	58	NS-753-01	70				
NS-679-19	59	NS-753-02	70				
NS-679-22	59	NS-753-03	70				
NS-680-03	59	NS-755-21	71				
NS-680-04	59	NS-790-06	71				
NS-681-03	59	NS-790-08	71				
NS-682-04	59	NS-790-10	71				
NS-683-03	59	NS-790-12	71				
NS-684-04	60	NS-792-00	71				
NS-684-06	60	NS-900-01	72				
NS-685-04	60	NS-900-02	72				
NS-685-06	60	NS-900-03	72				
NS-686-04	60	NS-900-04	72				
NS-686-06	60	NS-910-01	72				
NS-687-04	60	NS-910-02	72				
NS-687-06	60	NS-910-03	72				
NS-688-01	61	NS-910-04	72				
NS-688-02	61	NS-920-01	73				
NS-688-03	61	NS-920-02	73				
NS-688-04	61	NS-920-03	73				
NS-688-09	61	NS-920-04	73				
NS-688-10	61	NS-922-01	73				
NS-688-13	61	NS-922-02	73				
NS-689-01	62	NS-922-03	73				
NS-689-02	62	NS-922-04	73				
NS-689-03	62						
NS-689-04	62						
NS-690-21	62						
NS-691-10	63						
NS-691-15	63						
NS-691-20	63						
NS-691-25	63						
NS-691-30	63						
NS-691-35	63						
NS-691-40	63						
NS-691-50	63						
NS-693-15	63						
NS-693-30	63						
NS-693-45	63						
NS-693-60	63						
NS-694-18	64						
NS-694-25	64						
NS-695-26	64						
NS-697-26	65						
NS-699-26	65						
NS-701-26	65						
NS-703-01	66						
NS-703-02	66						
NS-703-03	66						
NS-703-04	66						
NS-711-26	67						
NS-713-26	67						
NS-715-26	76						
NS-717-22	67						
NS-717-32	67						
NS-719-01	68						
NS-719-02	68						
NS-729-08	68						
NS-730-23	68						
NS-731-23	68						
NS-733-23	68						
NS-734-23	69						
NS-735-23	69						
NS-737-01	69						
NS-737-02	69						
NS-739-01	69						
NS-739-02	69						
NS-740-01	70						
NS-740-02	70						
NS-741-01	70						
NS-741-02	70						
NS-751-01	70						
NS-751-02	70						



Neurosurgery Surgery Sets



**SURTEX**  
INSTRUMENTS

*Crafted to Excellence*

### Laminectomy Set

Codes	Description	Quantity
SL-010-03	Bard-Parker Scalpel Handle No. 3 Solid 12 cm - 4 3/4"	1
SL-010-04	Bard-Parker Scalpel Handle No. 4 Solid 13.5 cm - 5 3/8 "	1
SL-030-07	Scalpel Handle No. 7 Solid 16 cm - 6 1/4"	1
SS-004-14	Operating Scissor Straight - Sharp/Blunt 14.5 cm - 5 3/4"	1
SS-005-14	Operating Scissor Curved - Sharp/Blunt 14.5 cm - 5 3/4"	1
SS-040-17	Mayo Dissecting Scissor Straight 17 cm - 6 3/4"	1
SS-041-17	Mayo Dissecting Scissor Curved 17 cm - 6 3/4"	1
AF-160-12	Halsted-Mosquito Haemostatic Forcep Straight 12.5 cm - 5"	12
AF-161-12	Halsted-Mosquito Haemostatic Forcep Curved 12 cm - 4 3/4"	12
AF-210-14	Crile Haemostatic Forcep Straight 14.5 cm - 5 3/4"	12
AF-211-14	Crile Haemostatic Forcep Curved 14 cm - 5 1/2"	12
FR-010-14	Standard Pattern Dressing Forcep 14.5 cm - 5 3/4"	1
FR-010-20	Standard Pattern Dressing Forcep 20 cm - 8"	2
FR-200-14	Standard Pattern Dissecting Forcep 1 x 2 Teeth 14.5 cm - 5 3/4"	1
FR-200-20	Standard Pattern Dissecting Forcep 1 x 2 Teeth 20 cm - 8"	2
FR-090-17	Cushing Dressing Forcep Straight 17.5 cm - 7"	1
FR-294-17	Cushing Dissecting Forcep 1 x 2 Teeth 18 cm - 7"	1
FR-590-16	DeBakey Atrauma Forcep 16 cm - 6 1/4" Tip Size 1.5 mm	2
SI-015-15	Allis Intestinal and Tissue Grasping Forcep 5 x 6 Teeth 15.5 cm - 6"	4
OR-943-18	Luer Bone Rongeur Curved 18 cm - 7"	1
OR-982-01	Stille-Liston Bone Cutting Forcep Straight - Compound Action 27.5 cm - 10 3/4"	1
OR-985-27	Liston-Key Bone Cutting Forcep Compound Action 25.5 cm - 10"	1
OR-964-22	Stille-Luer Bone Rongeur Straight - Compound Action 22.5 cm - 8 3/4"	1
OR-965-22	Stille-Luer Bone Rongeur Curved - Compound Action 22 cm - 8 3/4"	1
OR-961-01	Leksell-Stille Bone Rongeur Compound Action 24.5 cm - 9 3/4"	1
OR-528-30	Bruns Bone Curette Round - Fig. 000 17 cm - 6 3/4"	1
OR-528-20	Bruns Bone Curette Round - Fig. 00 17 cm - 6 3/4"	1
OR-528-10	Bruns Bone Curette Round - Fig. 0 17 cm - 6 3/4"	1
OR-528-01	Bruns Bone Curette Round - Fig. 1 17 cm - 6 3/4"	1
OR-528-02	Bruns Bone Curette Round - Fig. 2 17 cm - 6 3/4"	1
OR-528-03	Bruns Bone Curette Round - Fig. 3 17 cm - 6 3/4"	1
OR-528-04	Bruns Bone Curette Round - Fig. 4 17 cm - 6 3/4"	1
RT-696-20	Weitlaner Self Retaining Retractor 3 x 4 Sharp Prongs 20 cm - 8"	2
RT-753-33	Adson Self Retaining Retractor 4 x 5 Blunt Prongs 33 cm - 13"	2
RT-977-17	Inge Lamina Spreader 16 cm - 6 1/4"	1
NS-171-02	Penfield Dura Dissector Fig.2 19.5 cm - 7 3/4"	1
NS-190-21	Love Nerve Root Retractor Straight 21.5 cm - 8 1/2"	1
NS-191-18	Love Nerve Root Retractor Angled 45° 17.5 cm - 7"	1
NS-251-01	Dandy Nerve Retractor 20 cm - 8"	1
NS-253-29	Smithwick Nerve Retractor 29 cm - 11 1/2"	1
NS-406-01	Love-Gruenwald Laminectomy Rongeur Straight 18 cm - 7" Bite Size 3 x 10 mm	1
NS-406-02	Love-Gruenwald Laminectomy Rongeur Up 18 cm - 7" Bite Size 3 x 10 mm	1
NS-406-03	Love-Gruenwald Laminectomy Rongeur Down 18 cm - 7" Bite Size 3 x 10 mm	1
NS-306-02	Ferris-Smith Kerrison Punch 40° Forward Up Cutting 18 cm - 7" Bite Size 2 mm	1
NS-306-03	Ferris-Smith Kerrison Punch 40° Forward Up Cutting 18 cm - 7" Bite Size 3 mm	1
NS-306-04	Ferris-Smith Kerrison Punch 40° Forward Up Cutting 18 cm - 7" Bite Size 4 mm	1
NS-306-05	Ferris-Smith Kerrison Punch 40° Forward Up Cutting 18 cm - 7" Bite Size 5 mm	1
AF-773-13	Backhaus Towel Clamp 13 cm - 5"	12
OT-207-18	Adson Ear Forcep Bayonet Shaped 17.5 cm - 7"	1
SS-141-18	Metzenbaum-Nelson Dissecting Scissor Curved - Blunt/Blunt 18 cm - 7"	1
SS-325-23	Strully Neurological Scissor Curved 22.5 cm - 8 3/4"	1
SU-600-20	UltraGripX TC Mayo-Hegar Needle Holder 20 cm - 8"	2
SF-350-25	Foerster Sponge Holding Forcep Straight 25 cm - 9 3/4"	6

### Lumbar Puncture Set

Codes	Description	Quantity
SL-010-03	Bard-Parker Scalpel Handle No. 3 Solid 12 cm - 4 3/4"	1
SS-006-14	Operating Scissor Straight - Sharp/Sharp 14.5 cm - 5 3/4"	1
FR-010-14	Standard Pattern Dressing Forcep 14.5 cm - 5 3/4"	1
AF-761-09	Jones Towel Clamp Sharp 8.5 cm - 3 1/4"	1
AF-200-14	Kelly Haemostatic Forcep Straight 14.5 cm - 5 3/4"	1
SU-050-15	Crile-Wood Needle Holder 15 cm - 6"	1
SF-350-18	Foerster Sponge Holding Forcep Straight 18 cm - 7"	1
TR-460-12	Tuohy Lumbar Puncture Needle 18 G - With Luer Lock Connection - Special Tip Needle Size ? 1.2 x 76 mm	1
TR-460-14	Tuohy Lumbar Puncture Needle 17 G - With Luer Lock Connection - Special Tip Needle Size ? 1.4 x 76 mm	1
TR-460-16	Tuohy Lumbar Puncture Needle 16 G - With Luer Lock Connection - Special Tip Needle Size √ø 1.6 x 76 mm	1

### Sympathectomy Set

Codes	Description	Quantity
AF-773-13	Backhaus Towel Clamp 13 cm - 5"	8
SF-350-25	Foerster Sponge Holding Forcep Straight 25 cm - 9 3/4"	4
SL-010-03	Bard-Parker Scalpel Handle No. 3 Solid 12 cm - 4 3/4"	2
SS-141-28	Metzenbaum-Nelson Dissecting Scissor Curved - Blunt/Blunt 28.5 cm - 11 1/4"	1
SS-141-18	Metzenbaum-Nelson Dissecting Scissor Curved - Blunt/Blunt 18 cm - 7"	1
FR-010-20	Standard Pattern Dressing Forcep 20 cm - 8"	2
FR-010-30	Standard Pattern Dressing Forcep 30.5 cm - 12"	2
AF-230-16	Ochsner-Kocher Haemostatic Forcep Straight - 1 x 2 Teeth 16.5 cm - 6 1/2"	4
RT-471-07	Deaver Retractor Fig. 7 30 cm - 11 3/4" Blade Width 38 mm	2
RT-471-09	Deaver Retractor Fig. 9 31.5 cm - 12 1/2" Blade Width 75 mm	2
AF-321-20	Rochester-Carmalt Haemostatic Forcep Curved 20 cm - 8"	6
AF-221-24	Rochester-Pean Haemostatic Forcep Curved 24 cm - 9 1/2"	1
RT-042-02	Cushing Nerve Hook Blunt - Fig.2 28 cm - 11"	1
AF-479-01	Zenker Dissecting and Ligature Forcep Curved 29.5 cm - 11 1/2"	1
SU-060-16	Mayo-Hegar Needle Holder 16 cm - 6 1/4"	1
SU-060-24	Mayo-Hegar Needle Holder 24 cm - 9 1/2"	2

### Craniotomy Set

Codes	Description	Quantity
SL-010-03	Bard-Parker Scalpel Handle No. 3 Solid 12 cm - 4 3/4"	1
SS-860-14	UltraCut TC Mayo Dissecting Scissor Straight 14.5 cm - 5 3/4"	1
SS-861-14	UltraCut TC Mayo Dissecting Scissor Curved 14.5 cm - 5 3/4"	1
SS-905-18	UltraCut TC Metzenbaum Dissecting Scissor Curved 18 cm - 7"	1
SS-281-25	Potts-Smith Vascular Scissor Angled 25° 19 cm - 7 1/2"	1
SS-104-15	Joseph Dissecting Scissor / Opreating Scissor Straight 15 cm - 6"	1
FR-274-15	Semken Dissecting Forcep 1 x 2 Teeth 15.5 cm - 6"	1
FR-250-12	Adson Dissecting Forcep 1 x 2 Teeth 12 cm - 4 3/4"	1
FR-294-17	Cushing Dissecting Forcep 1 x 2 Teeth 18 cm - 7"	1
FR-050-12	Adson Dressing Forcep 12 cm - 4 3/4"	1
OT-213-21	Jansen Ear Forcep Bayonet Shaped 21.5 cm - 8 1/2"	1
AF-170-12	Micro-Mosquito Haemostatic Forcep Straight 12 cm - 4 3/4"	6
AF-171-12	Micro-Mosquito Haemostatic Forcep Curved 11.5 cm - 4 1/2"	6
AF-283-14	Dandy Haemostatic Forcep Laterally Curved 14.5 cm - 5 3/4"	12
AF-230-16	Ochsner-Kocher Haemostatic Forcep Straight - 1 x 2 Teeth 16.5 cm - 6 1/2"	2
AF-230-18	Ochsner-Kocher Haemostatic Forcep Straight - 1 x 2 Teeth 18.5 cm - 7 1/4"	2
AF-268-18	Adson Haemostatic Forcep Straight 19 cm - 7 1/2"	2
AF-269-18	Adson Haemostatic Forcep Curved 18.5 cm - 7 1/4"	2
AF-773-08	Backhaus Towel Clamp 9 cm - 3 1/2"	8
AF-773-13	Backhaus Towel Clamp 13 cm - 5"	8
SF-350-25	Foerster Sponge Holding Forcep Straight 25 cm - 9 3/4"	1
SU-594-15	UltraGripX TC Crile-Wood Needle Holder 15 cm - 6"	1
SU-594-18	UltraGripX TC Crile-Wood Needle Holder 18 cm - 7"	1
SS-991-12	UltraCut TC Universal Wire Cutting Scissor Angled - One Toothed Cutting Edge 12.5 cm - 5"	1
RT-677-10	Jansen Self Retaining Retractor 3 x 3 Blunt Prongs - With Adjustment Screw 10 cm - 4"	1
RT-162-16	Senn-Miller Retractor Sharp 16 cm - 6 1/4" Blade Size 20 x 7 mm	2
RT-224-04	Murphy Retractor 4 Sharp Prongs 19.5 cm - 7 3/4"	2
RT-750-32	Beckmann Self Retaining Retractor 4 x 4 Sharp Prongs 32 cm - 12 1/2"	1
RT-686-20	Anderson-Adson Self Retaining Retractor 4 x 4 Sharp Prongs 20 cm - 8"	1
SI-015-15	Allis Intestinal and Tissue Grasping Forcep 5 x 6 Teeth 15.5 cm - 6"	2
RH-475-18	Freer Septum Elevator Double Ended - Sharp/Blunt 18.5 cm - 7 1/4" Blade Size 1 - Blade Size 2 5.0 mm - 5.0 mm	1
TR-101-07	Frazier Suction Tube 7 Charr. 19.5 cm - 7 3/4" √ø 2.3 mm	1
TR-101-09	Frazier Suction Tube 9 Charr. 19.5 cm - 7 3/4" √ø 3.0 mm	1
OR-951-18	Zaufal-Jansen Bone Rongeur Compound Action 18 cm - 7"	1
NS-190-21	Love Nerve Root Retractor Straight 21.5 cm - 8 1/2"	1
OR-965-22	Stille-Luer Bone Rongeur Curved - Compound Action 22 cm - 8 3/4"	1
OR-050-00	Hudson Hand Drill Complete Complete with 4 Burrs Ref. OR-050-01 up to OR-050-04	1
NS-050-50	Gigli Wire Saw 50 cm - 19 3/4"	2
NS-055-00	Gigli Wire Saw Handle (Pair)	1
NS-058-00	De Martel Wire Saw Guide 33 cm - 13"	1
OR-942-18	Luer Bone Rongeur Straight 18.5 cm - 7 1/4"	1
NS-406-01	Love-Gruenwald Laminectomy Rongeur Straight 18 cm - 7" Bite Size 3 x 10 mm	1
NS-306-03	Ferris-Smith Kerrison Punch 40° Forward Up Cutting 18 cm - 7" Bite Size 3 mm	1
NS-451-03	Schlesinger Laminectomy Rongeur Serrated Jaws 13 cm - 5" Bite Size 3 x 10 mm	1
NS-218-15	Heifetz Brain Spatulas 20 cm - 8" Blade Size 15 + 17 mm	1
NS-155-01	Frazier Dura Dissector 15 cm - 6"	1
NS-241-18	Frazier Dura Hook Sharp 18 cm - 7"	2
NS-235-20	Adson Dura Hook Blunt 20 cm - 8"	1
NS-251-01	Dandy Nerve Retractor 20 cm - 8"	1
NS-191-18	Love Nerve Root Retractor Angled 45° 17.5 cm - 7"	1
NS-193-11	Love Nerve Root Retractor Angled 90° 11 cm - 4 1/4"	1
OR-639-01	Cushing Periosteal Raspatory / Elevator 17.5 cm - 7"	1
OR-643-19	Langenbeck Periosteal Raspatory / Elevator 19.5 cm - 7 3/4"	1
OR-685-02	Adson Periosteal Raspatory / Elevator 17 cm - 6 3/4"	1

Head & Neck Surgery Set

Codes	Description	Quantity
SL-010-03	Bard-Parker Scalpel Handle No. 3 Solid 12 cm - 4 3/4"	1
SL-020-13	Scalpel Handle No. 3L Solid, Long 21.5 cm - 8 1/2"	1
SS-903-14	UltraCut TC Metzenbaum Dissecting Scissor Curved 14.5 cm - 5 3/4"	1
SS-905-18	UltraCut TC Metzenbaum Dissecting Scissor Curved 18 cm - 7"	1
SS-890-17	UltraCut TC Mayo-Stille Dissecting Scissor Straight 17 cm - 6 3/4"	1
SS-891-17	UltraCut TC Mayo-Stille Dissecting Scissor Curved 17 cm - 6 3/4"	1
AF-160-12	Halsted-Mosquito Haemostatic Forcep Straight 12.5 cm - 5"	6
AF-161-12	Halsted-Mosquito Haemostatic Forcep Curved 12 cm - 4 3/4"	16
AF-221-16	Rochester-Pean Haemostatic Forcep Curved 16 cm - 6 1/4"	6
AF-230-16	Ochsner-Kocher Haemostatic Forcep Straight - 1 x 2 Teeth 16.5 cm - 6 1/2"	4
AF-210-14	Crile Haemostatic Forcep Straight 14.5 cm - 5 3/4"	4
AF-211-14	Crile Haemostatic Forcep Curved 14 cm - 5 1/2"	20
TM-252-15	Lahey Goitre Grasping Forcep 3 x 3 Teeth 15.5 cm - 6"	6
AF-493-14	Mixer-Baby Dissecting and Ligature Forcep Curved 13.5 cm - 5 1/4"	2
FR-010-16	Standard Pattern Dressing Forcep 16 cm - 6 1/4"	2
FR-200-16	Standard Pattern Dissecting Forcep 1 x 2 Teeth 16 cm - 6 1/4"	2
SU-594-15	UltraGripX TC Crile-Wood Needle Holder 15 cm - 6"	2
SU-600-16	UltraGripX TC Mayo-Hegar Needle Holder 16 cm - 6 1/4"	2
AF-171-12	Micro-Mosquito Haemostatic Forcep Curved 11.5 cm - 4 1/2"	12
RT-712-13	Weitlaner Self Retaining Retractor 3 x 4 Sharp Prongs 13.5 cm - 5 1/4"	2
SI-060-16	Babcock Intestinal and Tissue Grasping Forcep 15.5 cm - 6"	2
SI-012-15	Allis Intestinal and Tissue Grasping Forcep 4 x 5 Teeth 15.5 cm - 6"	20
RT-742-13	Adson Self Retaining Retractor 3 x 4 Sharp Prongs 14 cm - 5 1/2"	2
FR-258-12	Adson-Brown Dissecting Forcep 7 x 7 Teeth 12 cm - 5"	2
RH-475-18	Freer Septum Elevator Double Ended - Sharp/Blunt 18.5 cm - 7 1/4"	1
	Blade Size 1 - Blade Size 2 5.0 mm - 5.0 mm	
RT-012-02	Gillies Skin Hook Fig. 2 18 cm - 7"	2
RT-064-01	Rollet Fine Wound Retractor 4 Sharp Prongs 13.5 cm - 5 1/4" Width 7.0 mm	2
AF-781-13	Lorna Towel Clamp Fine Serrated, Wide Jaw 13 cm - 5"	2
AF-773-13	Backhaus Towel Clamp 13 cm - 5"	4
RT-174-12	Cushing Retractor / Saddle Hook 24 cm - 9 1/2"	2
AF-269-18	Adson Haemostatic Forcep Curved 18.5 cm - 7 1/4"	4
FR-250-12	Adson Dissecting Forcep 1 x 2 Teeth 12 cm - 4 3/4"	2
FR-050-12	Adson Dressing Forcep 12 cm - 4 3/4"	2
FR-592-16	DeBakey Atrauma Forcep 16 cm - 6 1/4"	2
AF-471-16	Gemini Dissecting and Ligature Forcep Curved 16 cm - 6 1/4"	4
RT-579-21	Parker-Langebeck (US Army) Retractor Set of Fig. 1 (21 mm x 15 / 40 mm x 15 mm) and Fig. 2 (25 mm x 15 / 45 mm x 15 mm) 21.5 cm	1
		2
RT-403-01	Richardson Retractor 23.5 cm - 9 1/4" Blade Size 25 x 21 mm	2
RT-403-02	Richardson Retractor 24 cm - 9 1/2" Blade Size 30 x 29 mm	2
RT-210-04	Volkman Retractor 4 Sharp Prongs 22 cm - 8 3/4"	2
RT-162-16	Senn-Miller Retractor Sharp 16 cm - 6 1/4" Blade Size 20 x 7 mm	1
SS-453-11	Stevens Tenotomy Scissor Curved - Blunt/Blunt 11 cm - 4 1/2"	2
RT-120-12	Desmarres Lid Retractor 16 cm - 6 1/4" Blade Width 12.0 mm	2
TL-031-22	Hurd Tonsil Dissector / Retractor 22.5 cm - 8 3/4" Blade Width 11.0 mm - 14.0 mm	3
SF-350-25	Foerster Sponge Holding Forcep Straight 25 cm - 9 3/4"	2
TR-101-09	Frazier Suction Tube 9 Charr. 19.5 cm - 7 3/4" √ø 3.0 mm	1
TR-101-12	Frazier Suction Tube 12 Charr. 19.5 cm - 7 3/4" √ø 4.0 mm	1
RT-807-18	Gelpi Self Retaining Retractor 18 cm - 7"	1
NS-573-02	Krayenbuhl Micro Nerve & Vessel Hook Fig. 2 18.5 cm - 7 1/4"	1
RT-540-06	Martin Abdominal Spatula Malleable - Very Soft 20 cm - 8" Blade Width 6.5 mm	1
RT-540-09	Martin Abdominal Spatula Malleable - Very Soft 20 cm - 8" Blade Width 9.5 mm	1
RT-540-13	Martin Abdominal Spatula Malleable - Very Soft 20 cm - 8" Blade Width 13 mm	1
RT-540-16	Martin Abdominal Spatula Malleable - Very Soft 20 cm - 8" Blade Width 16 mm	1
RT-540-19	Martin Abdominal Spatula Malleable - Very Soft 20 cm - 8" Blade Width 19 mm	1
RT-540-25	Martin Abdominal Spatula Malleable - Very Soft 20 cm - 8" Blade Width 25 mm	1

Peripheral Nerve Repair Set

Codes	Description	Quantity
SL-010-03	Bard-Parker Scalpel Handle No. 3 Solid 12 cm - 4 3/4"	2
SL-010-04	Bard-Parker Scalpel Handle No. 4 Solid 13.5 cm - 5 3/8 "	1
SF-151-27	Gross-Maier Dressing Forcep Curved - With Ratchet 26 cm - 10 1/4"	4
SF-150-27	Gross-Maier Dressing Forcep Straight - With Ratchet 26.5 cm - 10 1/2"	2
SI-012-15	Allis Intestinal and Tissue Grasping Forcep 4 x 5 Teeth 15.5 cm - 6"	2
AF-773-08	Backhaus Towel Clamp 9 cm - 3 1/2"	4
AF-773-11	Backhaus Towel Clamp 11.5 cm - 4 1/2"	8
SS-176-16	Lexer Dissecting Scissor Straight 16 cm - 6 1/4"	2
SS-201-14	Metzenbaum-Fino Delicate Dissecting Scissor Curved - Blunt/Blunt Slender Pattern 14.5 cm - 5 3/4"	1
SS-245-15	Nerve Dissecting Scissor Curved - Semi Sharp 15 cm - 6"	1
SS-005-16	Operating Scissor Curved - Sharp/Blunt 16.5 cm - 6 1/2"	1
SS-457-11	Strabismus Scissor Curved 11.5 cm - 4 1/2"	1
SS-441-11	Iris Scissor Curved 11.5 cm - 4 1/2"	1
SS-991-12	UltraCut TC Universal Wire Cutting Scissor Angled - One Toothed Cutting Edge 12.5 cm - 5"	1
FR-590-16	DeBakey Atrauma Forcep 16 cm - 6 1/4" Tip Size 1.5 mm	2
FR-010-14	Standard Pattern Dressing Forcep 14.5 cm - 5 3/4"	2
FR-200-14	Standard Pattern Dissecting Forcep 1 x 2 Teeth 14.5 cm - 5 3/4"	2
FR-250-12	Adson Dissecting Forcep 1 x 2 Teeth 12 cm - 4 3/4"	2
AF-161-12	Halsted-Mosquito Haemostatic Forcep Curved 12 cm - 4 3/4"	10
AF-160-12	Halsted-Mosquito Haemostatic Forcep Straight 12.5 cm - 5"	10
AF-411-18	Adson-Baby Dissecting and Ligature Forcep Curved 18 cm - 7"	2
AF-471-18	Gemini Dissecting and Ligature Forcep Curved 18 cm - 7"	2
RT-172-14	Cushing Retractor / Saddle Hook 20.5 cm - 8" Blade Size 14 mm	2
RT-100-04	Wound Retractor 4 Sharp Prongs - Small Curve 16.5 cm - 6 1/2" Width 9.5 mm	2
RT-251-02	Langenbeck Retractor 22.5 cm - 8 3/4" Blade Size 30 x 14 mm	2
RT-713-16	Weitlaner Self Retaining Retractor 3 x 4 Blunt Prongs 16 cm - 6 1/4"	1
RT-713-13	Weitlaner Self Retaining Retractor 3 x 4 Blunt Prongs 13.5 cm - 5 1/4"	1
RT-220-03	Kocher Retractor 3 Sharp Prongs 22 cm - 8 3/4"	2
RT-220-04	Kocher Retractor 4 Sharp Prongs 22 cm - 8 3/4"	2
RT-561-01	Roux Retractor Fig. 1 14 cm - 5 1/2"	1
PR-010-16	Probe 16 cm - 6 1/4" Tip √ø 1 mm	1
PR-010-14	Probe 14.5 cm - 5 3/4" Tip √ø 1 mm	1
PR-131-14	Doyen Butterfly Probe / Grooved Director 14.5 cm - 5 3/4"	1
DI-880-15	Ruler Graduated in mm and inches 16.5 cm - 6 1/2" Measuring Range 150 mm	1
TR-091-20	Adson Suction Tube 12 Charr. 20 cm - 8" √ø 4.0 mm	1
TR-223-15	Yasargil Suction Tube With Luer Hub Working Length - Diameter 150 mm - 1.5 mm	1
SU-594-15	UltraGripX TC Crile-Wood Needle Holder 15 cm - 6"	1
SU-650-18	UltraGripX TC DeBakey Needle Holder 18 cm - 7"	2
SU-863-13	Kronecker Ligature Needle Delicate for Left Hand 12.5 cm - 5"	1
RT-040-01	Cushing Nerve Hook Blunt - Fig.1 19 cm - 7 1/2"	2

Hydrocephalus Shunt Operations Set (VP SHUNT)

Codes	Description	Quantity
AF-773-08	Backhaus Towel Clamp 9 cm - 3 1/2"	4
SL-010-03	Bard-Parker Scalpel Handle No. 3 Solid 12 cm - 4 3/4"	1
SL-030-07	Scalpel Handle No. 7 Solid 16 cm - 6 1/4"	1
SF-350-18	Foerster Sponge Holding Forcep Straight 18 cm - 7"	4
SS-040-14	Mayo Dissecting Scissor Straight 14.5 cm - 5 3/4"	1
SS-130-14	Metzenbaum Dissecting Scissor Straight - Blunt/Blunt 14.5 cm - 5 3/4"	1
SS-440-11	Iris Scissor Straight 11.5 cm - 4 1/2"	1
FR-250-12	Adson Dissecting Forcep 1 x 2 Teeth 12 cm - 4 3/4"	2
FR-258-12	Adson-Brown Dissecting Forcep 7 x 7 Teeth 12 cm - 5"	2
FR-074-17	Taylor Dressing Forcep 17 cm - 6 3/4"	1
FR-090-17	Cushing Dressing Forcep Straight 17.5 cm - 7"	2
FR-282-17	Taylor Dissecting Forcep With Dissector End - 1 x 2 Teeth 17 cm - 6 3/4"	2
AF-160-12	Halsted-Mosquito Haemostatic Forcep Straight 12.5 cm - 5"	8
AF-161-12	Halsted-Mosquito Haemostatic Forcep Curved 12 cm - 4 3/4"	8
AF-211-14	Crile Haemostatic Forcep Curved 14 cm - 5 1/2"	1
AF-215-16	Crile-Rankin Haemostatic Forcep Curved 17 cm - 6 3/4"	1
AF-230-14	Ochsner-Kocher Haemostatic Forcep Straight - 1 x 2 Teeth 14.5 cm - 5 3/4"	1
AF-285-14	Dandy Haemostatic Forcep Laterally Curved - 1 x 2 Teeth 14.5 cm - 5 3/4"	8
SI-015-15	Allis Intestinal and Tissue Grasping Forcep 5 x 6 Teeth 15.5 cm - 6"	2
OR-951-18	Zaufal-Jansen Bone Rongeur Compound Action 18 cm - 7"	1
RT-162-16	Senn-Miller Retractor Sharp 16 cm - 6 1/4" Blade Size 20 x 7 mm	2
RT-677-10	Jansen Self Retaining Retractor 3 x 3 Blunt Prongs - With Adjustment Screw 10 cm - 4"	2
RT-713-13	Weitlaner Self Retaining Retractor 3 x 4 Blunt Prongs 13.5 cm - 5 1/4"	1
RT-669-07	Alm Wound Spreader 4 x 4 Blunt Prongs 7 cm - 2 3/4"	1
OR-532-02	Bruns Bone Curette Oval - Solid Handle - Fig. 2 23 cm - 9" Scoop Size 4.8 mm	1
PR-030-13	Probe With Eye 13 cm - 5" Tip √ø 2 mm	1
DI-880-15	Ruler Graduated in mm and inches 16.5 cm - 6 1/2" Measuring Range 150 mm	1
TR-101-10	Frazier Suction Tube 10 Charr. 19.5 cm - 7 3/4" √ø 3.3 mm	1
SU-600-16	UltraGripX TC Mayo-Hegar Needle Holder 16 cm - 6 1/4"	2
FR-256-12	Micro-Adson Dissecting Forcep 1 x 2 Teeth 12 cm - 4 3/4"	1
SU-520-18	UltraGripX TC Micro Needle Holder Straight - With Lock 18 cm - 7"	1
SU-955-03	Koenig Ligature Conductor 19.5 cm - 7 3/4"	1
SU-863-13	Kronecker Ligature Needle Delicate for Left Hand 12.5 cm - 5"	1
CV-459-17	Glover Atrauma Multipurpose Vascular Clamp 17.5 cm - 7"	1
CV-477-13	DeBakey Atrauma Pediatric Vascular Clamp 12.5 cm - 5"	2
SS-004-14	Operating Scissor Straight - Sharp/Blunt 14.5 cm - 5 3/4"	0

### Exploration Set

Codes	Description	Quantity
NS-581-01	Caspar Exploration Hook Fig. 1 24.5 cm - 9 1/2"	1
NS-581-02	Caspar Exploration Hook Fig. 2 24.5 cm - 9 1/2"	1
NS-581-03	Caspar Exploration Hook Fig. 3 24.5 cm - 9 1/2"	1
NS-581-04	Caspar Exploration Hook Fig. 4 24.5 cm - 9 1/2"	1

### Skull Traction Set

Codes	Description	Quantity
SF-350-25	Foerster Sponge Holding Forcep Straight 25 cm - 9 3/4"	2
SL-010-03	Bard-Parker Scalpel Handle No. 3 Solid 12 cm - 4 3/4"	1
FR-200-14	Standard Pattern Dissecting Forcep 1 x 2 Teeth 14.5 cm - 5 3/4"	1
SS-004-14	Operating Scissor Straight - Sharp/Blunt 14.5 cm - 5 3/4"	1
AF-161-12	Halsted-Mosquito Haemostatic Forcep Curved 12 cm - 4 3/4"	1
NS-061-02	Crutchfield Skull Traction Tongs Medium Pattern	1
NS-065-35	Crutchfield Drill Point 7 cm - 2 3/4" Tip $\sqrt{\text{d}}$ 3.5 mm	1
NS-065-50	Crutchfield Drill Point 7 cm - 2 3/4" Tip $\sqrt{\text{d}}$ 5.0 mm	1
NS-061-01	Crutchfield Skull Traction Tongs Small Pattern	1
NS-071-00	Skull Traction Tongs Large Pattern	1

### Micro Nerve Repair Set

Codes	Description	Quantity
AF-170-10	Backhaus Towel Clamp 13 cm - 5"	5
AF-171-10	Foerster Sponge Holding Forcep Straight 25 cm - 9 3/4"	5
RT-024-01	Bard-Parker Scalpel Handle No. 3 Solid 12 cm - 4 3/4"	2
SU-210-14	Metzenbaum-Nelson Dissecting Scissor Curved - Blunt/Blunt 28.5 cm - 11 1/4"	1
SL-010-03	Metzenbaum-Nelson Dissecting Scissor Curved - Blunt/Blunt 18 cm - 7"	1
SS-694-08	Standard Pattern Dressing Forcep 20 cm - 8"	1
SS-695-08	Standard Pattern Dressing Forcep 30.5 cm - 12"	1



### Neuro Microsurgery Set

Codes	Description	Quantity
FR-420-05	Lazar Micro Suturing Forcep 15.5 cm - 6" Tip Size 0.5 mm	1
FR-420-08	Lazar Micro Suturing Forcep 15.5 cm - 6" Tip Size 0.8 mm	1
FR-323-13	Vise Micro Jeweller Forcep Curved - With Plateau 13.5 cm - 5 1/4" Tip Size 0.3 mm	1
FR-407-20	Hunt Tumor Grasping Forcep Angled 20 cm - 8" Tip Size √ø 5.0 mm	1
FR-403-04	Yasargil Tumor Grasping Forcep Bayonet Shaped 22 cm - 8 3/4" Tip Size √ø 5.0 mm	1
SU-510-14	UltraGripX TC Castroviejo Micro Needle Holder Straight - With Lock 14.5 cm - 5 3/4"	1
SU-520-18	UltraGripX TC Micro Needle Holder Straight - With Lock 18 cm - 7"	1
SS-729-12	Vannas Micro Scissor Angled on Flat 12 cm - 4 3/4"	1
FR-403-01	Yasargil Tumor Grasping Forcep Bayonet Shaped 22 cm - 8 3/4" Tip Size √ø 3.0 mm	1
NS-575-02	Yasargil Ligature Guide Fig. 2 18.5 cm - 7 1/4"	1
NS-575-03	Yasargil Ligature Guide Fig. 3 18.5 cm - 7 1/4"	1
NS-590-00	Rhoton Micro Dissector Set of 15	1
NS-550-18	Jacobson Micro Knife Straight 18.5 cm - 7 1/4"	1
NS-235-20	Adson Dura Hook Blunt 20 cm - 8"	1
NS-573-03	Krayenbuhl Micro Nerve & Vessel Hook Fig. 3 18.5 cm - 7 1/4"	1
NS-573-04	Krayenbuhl Micro Nerve & Vessel Hook Fig. 4 18.5 cm - 7 1/4"	1
NS-711-26	Landolt-Reulen Micro Dissector Bayonet Shaped - Rigid 26 cm - 10 1/4" Tip Size 2.0 mm	1
SS-636-12	Micro Scissor Straight 12 cm - 4 3/4"	1
SS-637-12	Micro Scissor Curved 12 cm - 4 3/4"	1
SS-808-23	Jacobson Micro Scissor Straight - Bayonet Shaped 23 cm - 9"	1
SS-809-23	Potts Micro Scissor Curved Downwards - Bayonet Shaped 23 cm - 9"	1
SU-281-20	Yasargil Micro Needle Holder Curved - Bayonet Shaped - Smooth Jaws 20 cm - 8"	1
TR-101-06	Frazier Suction Tube 6 Charr. 19.5 cm - 7 3/4" √ø 2.0 mm	1
TR-101-09	Frazier Suction Tube 9 Charr. 19.5 cm - 7 3/4" √ø 3.0 mm	1

### Aneurysm Set

Codes	Description	Quantity
TR-115-05	Fukushima Tear Drop Suction Tube Straight Malleable 5 Fr. 18 cm - 7" Diameter 1.6 mm	1
TR-115-11	Fukushima Tear Drop Suction Tube Straight Malleable 11 Fr. 18 cm - 7" Diameter 3.6 mm	1
NS-591-16	Rhoton Micro Probe Angled 45° 18.5 cm - 7 1/4" Ø 1.0 mm	1
NS-591-02	Rhoton Micro Dissector Round Shaped 18.5 cm - 7 1/4" √d 2.0 mm	1
NS-591-05	Rhoton Micro Dissector Spatula Shaped 18.5 cm - 7 1/4" Tip Size 1.5 mm	1
NS-591-17	Rhoton Micro Probe Straight 18.5 cm - 7 1/4" Ø 1.0 mm	1
FR-411-18	Yasargil Micro Forcep Bayonet Shaped 18 cm - 7" Tip Size 0.6 mm	1
SS-807-23	Potts Micro Scissor Curved Upwards - Bayonet Shaped 23 cm - 9"	1
SS-810-23	Micro Scissor Straight - Bayonet Shaped 23 cm - 9"	1
SS-801-18	Micro Scissor Curved - Round Handle 18 cm - 7" Blade Size 10 mm	1

### LEYLA RETRACTOR SET

Codes	Description	Quantity
NS-010-22	Yasargil (Leyla) Fixation Base	1
NS-010-10	Yasargil (Leyla) Flexible Arm	2
NS-010-45	Yasargil (Leyla) Support for Flat Spatulas	2
NS-012-09	Yasargil (Leyla) Ball and Socket Joint Size 9 x 32 mm	1
NS-012-20	Yasargil (Leyla) Holding Rod	1
NS-012-25	Yasargil (Leyla) Coupling Head	1

### BASIC CASPAR RETRACTOR SET

Codes	Description	Quantity
RT-1263-02	Caspar Side Loading Rack Retractor Double Hinged	1
RT-1267-00	Caspar Side Loading Rack Retractor Double Hinged	2
RT-1275-40	Caspar Side Loading Lateral Blade Fenestrated Toothed 40 x 24 mm	1
RT-1275-45	Caspar Side Loading Lateral Blade Fenestrated Toothed 45 x 24 mm	1
RT-1275-50	Caspar Side Loading Lateral Blade Fenestrated Toothed 50 x 24 mm	1
RT-1275-55	Caspar Side Loading Lateral Blade Fenestrated Toothed 55 x 24 mm	1
RT-1275-60	Caspar Side Loading Lateral Blade Fenestrated Toothed 60 x 24 mm	1
RT-1271-40	Caspar Side Loading Medial Blade Fenestrated 5 Prongs 40 x 24 mm	1
RT-1271-45	Caspar Side Loading Medial Blade Fenestrated 5 Prongs 45 x 24 mm	1
RT-1271-50	Caspar Side Loading Medial Blade Fenestrated 5 Prongs 50 x 24 mm	1
RT-1271-50	Caspar Side Loading Medial Blade Fenestrated 5 Prongs 50 x 24 mm	1
RT-1271-60	Caspar Side Loading Medial Blade Fenestrated 5 Prongs 60 x 24 mm	1



SCAN FOR PDF PROFILE

**COPYRIGHT NOTICE**

The copyright, trademarks, domain names and other intellectual property rights in all materials and information in this presentation belongs to Surtex Instruments Ltd. All rights are reserved. Technical alterations are possible. This presentation may be used for no other purpose than offering, buying and selling of Surtex Instruments products. No part may be reproduced or copied in any form. In the event of misuse we retain the right to recall our catalogues and take appropriate legal action.

**DISCLAIMER**

This documents provides general information about Surtex Instruments Ltd, its products and services, and summarises general capabilities and offerings, which we deem to be relevant to our customers. Whilst Surtex Instruments has taken appropriate steps to ensure the accuracy of the information contained in the document Surtex Instruments gives no warranty regarding the accuracy or completeness of such information.

The presentation was prepared to provide information and does not constitute a contract. Surtex reserves the right, without prior notice, to change, delete, supplement, or otherwise amend at any time the information, images and offerings contained in the presentation or other documents. Surtex shall not be liable for any loss or damage of whatever nature (whether direct, indirect, consequential or other) may arise as a result of any third party relying on the information contained in this document.

For further detailed information, prices, terms and conditions, customer should contact Surtex Instruments at [sales@surtex-instruments.co.uk](mailto:sales@surtex-instruments.co.uk).

© 2021 SURTEX INSTRUMENTS. ALL RIGHTS RESERVED. PRINTED IN UNITED KINGDOM. BT1-01 Rev 1.0



Unit 202 Kingspark Business Centre  
152-178 Kingston Road, New Malden  
Surrey KT3 3ST United Kingdom  
Phone: +44 (0) 208 123 3513

E-mail: [sales@surtex-instruments.co.uk](mailto:sales@surtex-instruments.co.uk)  
Website: [www.surtex-instruments.com](http://www.surtex-instruments.com)

