



SURTEX
INSTRUMENTS

Crafted to Excellence





SURTEX INSTRUMENTS

Crafted to Excellence

• INTRODUCTION TO THE CATALOGUE

In this catalogue we are pleased to introduce the ophthalmic surgery instruments range available from Surtex Instruments. Following feedback from customers we have prepared this as a standalone catalogue to allow for quick referencing and searching of our products required on a routine basis. The specialist ranges of our instruments are covered in the following additional catalogues available upon request.

- ENT
- Cardiovascular & Neurosurgery
- Ophthalmic
- Gynaecology and Obstetrics
- Dental Instruments
- Sterilization & Holloware

• ABOUT SURTEX INSTRUMENTS

Surtex Instruments is a privately owned medical technology company dedicated to innovation and excellence in crafting of surgical instruments. The company started as a specialist in reconstructive surgery instruments and based on its success and innovative drive gradually expanded to cover a vast range of surgical instruments.

We now manufacture over 8,000 surgical instruments and offer innovative solutions in trauma, gynecology, cardiovascular, microsurgery and dental surgery. All our products are available to view online where you can download our entire range of catalogues or request a printed version.

• SURTEX QUALITY STANDARDS

In European Union medical devices are subject to a series of uniform laws and the EC directive places rigid demands on surgical instruments. Surtex Instruments is proud to claim that we have always surpassed the legal requirements to ensure that each instrument reaching the surgeons hand is indeed a testament to surgical craftsmanship.

We are **BS EN ISO 13485:2012/ISO 9001:2008 (SGS UK)** certified and **CE** approved to ensure compliance with the standards defined in line with medical devices directive **93/42/EEC**.



WHY IS SURTEX FOCUSED ON INSTRUMENTS QUALITY?

Surgeons are highly talented and skilled individuals. They operate under significant time constraints and are required to make split second decisions while performing complex operations. At Surtex we understand that in such a scenario the surgeon requires tools that are not just fit for the purpose but are reliable, dependable and crafted by a company that has a track record for relentless pursuit for excellence in the making of surgical instruments.



• AFFORDABLE QUALITY

Surgical instruments represent a significant proportion of hospital's total assets. Hospitals and health centers are often required to minimize costs of surgical instruments without impacting quality or patient's health. Decision makers tend to respond via group purchasing contracts & multiple quotes to shop around for the lowest price. However this approach has significant drawbacks as numerous instrument companies have focused towards competing on price alone with a disregard towards instruments quality while claiming their instruments to be guaranteed and free of defect.

The outcome for the buyer being a perceived notion of a quality instrument, which is actually little more than a knock-off and delivers only poor value for money.

At **Surtex Instruments** our success has been based on helping customers navigate successfully through the instrument procurement process by identifying real value for money through fair comparison. We believe that quality should be affordable and you should not pay too much for over priced brands and neither should you pay too much for a low quality instrument.

• LIFE TIME WARRANTY

We encourage our customers to calculate lifetime costs prior to making purchase decisions and investing in surgical instruments.

Surtex Instruments are guaranteed for life* against manufacturing defects of material and workmanship. This means we will repair or replace free of charge any surgical instrument that does not meet its functional requirements when used for its intended purpose and maintained properly.



*Conditions apply.

OUR PRODUCT BRANDS



A new dimension in cutting and dissecting performance. Our class leading integral self-sharpening technology standard on all Surtex scissors enabling precise cutting with minimum force even after pro-longed use.



These Surtex premium scissors feature finely ground micro serrations along one blade of the scissor preventing tissue slippage. The ultra sharp edge of the other blade cuts through the tissue precisely and atraumatically.



Instruments with this symbol benefit from tungsten carbide (TC) inserts expertly bonded on the cutting edge of the instrument. This material is harder than stainless steel and enables the instruments to last up to 6 times longer than standard instruments.



A true craftsmanship masterpiece and surgeons favourite. These are the best scissors in our range and combine the features of SuperEdge™ & UltraCut™ into a perfect pair of scissors that is precise, durable and reliable.



The only choice when the perfect grip matters. Utilising Creep Feed technology individual teeth are grinded into hard wear resistant tungsten carbide (TC). The result is super sharp teeth with well-defined point and inserts with impeccable gripping properties and instruments that last up to 6 times longer.



These instruments have jaws, which are coated with diamond dust resulting in improved gripping enabling superior manipulation of sutures, needles and tissues.



Our specially designed high strength fibre grip handles resulting in lightweight instruments. These ergonomic handles provide the surgeon with excellent feel, better grip, reduced shock, and less hand fatigue.



Surtex ENT diagnostic and anaesthesia instruments featuring direct bulb illumination of xenon grade bulbs.



This range features distal fibre optic to carry light from xenon bulb allowing cold illumination on operating site in our ENT diagnostics and anaesthesia instruments.



Premium grade ENT diagnostics and anaesthesia instruments combining features of distal fibre optic technology and ultra bright LED illumination ensuring the best in clear vision of operating site.

CURRENT REFERENCE STANDARDS FOR SURTTEX PRODUCTS

STANDARDS	CONTENTS OF THE STANDARD
BS EN ISO 9001:2008	Quality Management Systems certification standard.
BS EN ISO 13485:2003	Medical Devices – Quality Management Systems certification standard.
MDD 93/42/EEC, Annex II, Section 3.2	Medical Device Directive, 'EC Declaration of Conformity' (full quality assurance system).
MDD 93/42/EEC, Annex I	Essential Requirements for Medical Devices.
BS EN ISO 7153-1:2001 (BS 5194:Part 1:1991)	Surgical Instruments – Metallic materials part 1 - Stainless Steel
BS 5194:Part 2:1989	Specification for instruments with pivot joints (excluding cutting instruments)
BS 5194:Part 3:1985	Specification for Dissecting Forceps
BS 5194:Part 4:1985	Specification for scissors, shears, and other jointed cutting instruments
ISO 7151:1988	Surgical instruments – non-cutting, articulated instruments – general requirements & test methods
ISO 7740:2004	Scalpels with detachable blades - Fitting dimensions
ISO 7741:1986	Scissors and shears - General requirements and test methods
ISO 6508-1:2005 (DIN 50103-3:1995)	Specifies the method for Rockwell and Rockwell superficial hardness tests for metallic materials.
BS EN ISO 14971:2012	Medical Devices – Application of risk management to medical devices.
DIN 58298:2010-09	Medical instruments - Materials, finish and testing.
DIN 58299:1964-01	Serrations for surgical instruments; profile angles, groove distances.
DIN 58300:1982-02	Joints for surgical instruments.
HTM 2010	Recommendations for sterilization
AS/NZ 4187-2003	Cleaning, disinfecting & sterilising of re-usable surgical instruments

This information is available on the internet at
www.surttex-instruments.com

INSTRUCTIONS FOR REPROCESSING OF REUSABLE SURGICAL INSTRUMENTS

The following instructions are for all reusable medical devices supplied by Surtex Instruments Ltd, unless stated otherwise with the packaging of the product. These instructions are intended for use only by persons with the required specialist knowledge and training.

Warnings

- Follow instructions and warnings as issued by the manufacturers of any decontaminants, disinfectants and cleaning agents. Wherever possible avoid use of mineral acids and harsh, abrasive agents.
- No part of the process shall exceed 140 °C.
- Some sensitive materials (e.g. Aluminium) are damaged by high alkaline solutions (pH>10).
- Devices with long, narrow cannula, hinges and blind holes require particular attention during cleaning.

Note: When reprocessing medical devices, always handle with care, wearing protective clothing, gloves and eye-wear in accordance with local health & safety procedures.

Limitations on Reprocessing

- Repeated processing has minimal effect on these instruments.
- End of life normally determined by wear and damage in use.
- Any specific limitations on the number of reprocessing cycles shall be made available with instrument.

From Point of Use

Whenever possible, do not allow blood, debris or bodily fluids to dry on instruments. For best results and to prolong the life of the medical device reprocess immediately after use. If they cannot be reprocessed immediately, use an enzymatic foam spray cleaner to help prevent soil from drying.

Preparation for Decontamination

- Process all the instruments as soon as it is reasonably practical following use.
- Disassemble only where intended, without the use of tools unless specifically provided by the manufacturer. Instructions for dis assembly are available with the device, where required.

Cleaning: Automated

- Use only either CE marked or validated washer-disinfector machines and low foaming, non-ionizing cleaning agents and detergents following the manufacturer's instructions for use, warnings, concentrations and recommended cycles.
- Load instruments carefully, with any box joints and hinges open and so that any fenestration in instruments can drain.
- Place heavy instruments with care in the bottom of containers, taking care not to overload wash baskets.
- Place instruments with concave surfaces facing down to prevent pooling of water.
- Where possible, use appropriate attachments to flush inside reamers and devices with lumens or cannula.
- Ensure that soft, high purity water which is controlled for bacterial endo-toxins is used in the final rinse stage.

Note: Automated cleaning may not be suitable for all lumens and cannula in which case clean manually with a water jet gun, if available, and an appropriate brush (and stilette if provided) that reaches the depth of the feature. After manually cleaning, pass all devices through an automatic cleaning cycle to achieve disinfection.

Note: These instruments have been validated using a washer-disinfector cycle validated to include two cold rinses at <35 °C, a detergent cycle and a rinse cycle both at >50°C, a disinfection cycle operating at a temperature of between 80 °C and 90 °C for a minimum holding time of 1 minute (actual holding time in excess of 2 minutes 50 seconds) and a 20 minute drying cycle. The detergent used was low foaming, non-ionizing spray wash detergent cleaner (max 12pH) and the rinse aid a neutral pH low foaming, non-ionic surfactant with isopropyl alcohol.

Cleaning: Manual

- Manual cleaning is not advised if an automatic washer-disinfector is available. If the equipment is not available, use the following process:-
1. Use a double sink system (wash/rinse) dedicated for instrument cleaning (not used for hand washing). Ensure that the water temperature does not exceed 35 of the re-processor to ensure that the reprocessing as actually performed using equipment, materials and personnel in the reprocessing facility achieve the desired result. This requires validation and routine monitoring of the process. Likewise any deviation by the re-processor from the instructions provided must be properly evaluated for effectiveness and potential adverse consequences.
 2. In the first sink, keeping the instrument submerged, with an autoclavable brush, apply CE marked cleaning solution to all surfaces until all soil has been removed. Pay particular attention to serrations, teeth, ratchets and hinges, always brushing away from the body and avoiding splashing. Ensure rongeurs and hinged instruments are thoroughly cleaned in both open and closed positions.
 3. In the second sink, rinse instruments thoroughly with soft, high purity water which is controlled for bacterial endotoxins, so that the water reaches all parts of the instrument, then carefully hand dry or use a drying cabinet.

Note: Manual Cleaning is NOT a disinfection process: When manual cleaning is used it may not be possible to disinfect the device prior to further handling.

Cleaning Inspection

- After cleaning visually inspect, visually inspect all surfaces, cannulations, ratchets, joints, holes and lumens for complete removal of soil and fluids. If ANY soil or fluid is still visible, return the instrument for repeat decontamination.

Maintenance

- Apply surgical grade lubricant to hinges, joints and moving parts as per the lubricant manufacturer's instructions.

Continued on next page

Inspection and Functional Testing

- Visually inspect and check: - all instruments for damage and wear; cutting edges are free from nicks and present a continuous edge; jaws and teeth align correctly; all articulated instruments have a smooth movement without excess play; locking mechanisms (such as ratchets) fasten securely and close easily; long, slender instruments are not distorted; any component parts fit and assemble correctly with mating components.
- Remove for repair and replacement any blunt, worn out, flaking, fractured or damaged instruments.

Note: If an instrument is returned to the manufacturer / supplier, the instrument must be decontaminated and sterilized and be accompanied with the relevant documented evidence.

Packaging

- All instruments to be packed following local protocol in accordance with ISO 11607-1 or AAMI/CSR technique.

Sterilization (USA)

- Autoclave should comply with the requirements of, and be validated and maintained in accordance with ANSI/AAMI ST79.
- Pre-Vacuum moist heat sterilization operating at temperature 132 °C bar for a minimum holding time of 4 minutes always following the instructions of the machine manufacturer.
- When sterilizing multiple instruments in one autoclave cycle, ensure that the sterilizer manufacturers stated maximum load is not exceeded.
- Ensure instruments are dry before sterilization.

Sterilization (Outside USA)

- Autoclave should comply with the requirements of, and be validated and maintained in accordance with EN 285, EN 13060, EN ISO 17665.
- Either CE marked or validated vacuum autoclave operating at 134-137 °C bar for a minimum holding time of 3 minutes always following the instructions of the machine manufacturer.
- When sterilizing multiple instruments in one autoclave cycle, ensure that the sterilizer manufacturers stated maximum load is not exceeded.

Storage

- Ensure instruments are dry before storage, and stored in dry, clean conditions at an ambient room temperature.

Additional Information

- Other forms of cleaning (i.e. ultrasonic) and sterilization (i.e. Low temperature steam and Formaldehyde, Ethylene Oxide and Gas Plasma) are available. However, always follow the instructions for use as issued by the manufacturer and always consult with them if in any doubt over the suitability of any process used.
- Cleaning and sterilizing guidelines are available in HTM 2030 and HTM 2010. Contact: The NHS Estates Stationers Office Publications Cent for details at www.tsonline.gov.uk. For further information contact: NHS Estates Information Center, Department of Health, 1 Trevelyan Square, Boar Lane, Leeds, LS1 6AE, UK or visit www.nhsestates.gov.uk.

Note: It is the responsibility of the re-processor to ensure that the reprocessing as actually performed using equipment, materials and personnel in the reprocessing facility achieve the desired result. This requires validation and routine monitoring of the process. Likewise any deviation by the re-processor from the instructions provided must be properly evaluated for effectiveness and potential adverse consequences.

TABLE OF CONTENTS (A - Z)

Cannulas	28 - 38
Chisels & Gouges	166
Curettes & Spoons	39 - 40, 72
Fascia Needles, Cautery Balls	9
Fixation Rings	82 - 83
Forceps	123 - 162
Foreign Body Instruments	16 - 17
Haemostats & Bulldog Clamps	163
Hooks	81, 83 - 86, 178
Knives	11 - 24
Lens Loops	64 - 66
Markers	86 - 89
Mallet	78
Micro Manipulators	40 - 62, 66 - 70, 73 - 80
Needle Holders	167 - 177
Probes & Dilators	90 - 92, 179
Punches	26
Retractors, Lid Plates	7 - 10
Rongeurs	165, 179
Rulers & Calipers	90, 178
Scalpel Handles & Blades	93 - 94
Scissors	95 - 122
Scleral Markers & Depressors	7
Speculums	1 - 6
Sphere Introducers & Enucleation Instruments	71
Storing Cases	180
Towel Clamps	164
Trephines	25, 27
Ophthalmic Surgeries Sets	191-203



Eye Speculum
Lidsperrer
Blefarostatos
Blépharostats
Blefarostati

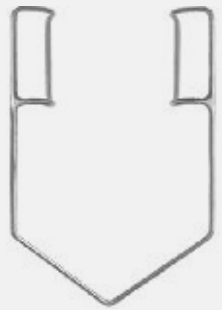

Barraquer Wire Speculum

OP-010-10

Pediatric
Wire Ø 0.9 mm
Blade Size 10 mm

OP-010-15

Adult
Wire Ø 0.9 mm
Blade Size 15 mm

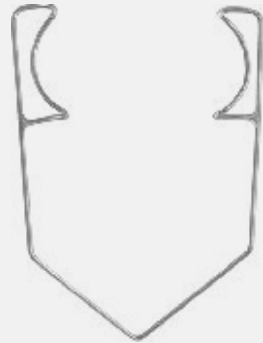

OP-012-15

Barraquer Wire Speculum

Heavy Wire Ø 1.0 mm
Blade Size 15 mm



**Barraquer Wire Speculum
(Solid Blades)**

OP-020-10

Pediatric
Blade Size 10 mm

OP-020-15

Adult
Blade Size 15 mm



OP-022-20

Feaster Wire Speculum

Solid Blades
Blade Size 20 mm



Kratz-Barraquer Wire Speculum

OP-030-13

With Open Blades, Wire Ø 0.9 mm
Blade Size 13 mm

OP-030-15

With Open Blades, Wire Ø 0.9 mm
Blade Size 15 mm

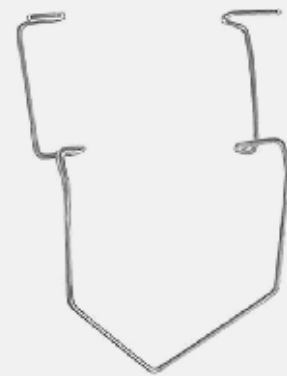

OP-032-15

Kratz-Barraquer Wire Speculum

With open blades, Wire Ø 1.0 mm
Blade Size 15 mm

Eye Speculum
Lidsperrer
Blefarostatos
Blépharostats
Blefarostati

OP

OPHTHALMIC SURGERY INSTRUMENTS



OP-040-10
Frankel Infant Lid Speculum
Adjustable Opening
Blade Size 10 mm



OP-042-00
Alfonso Infant Lid Speculum
With Finger Grip, Wire Ø 0.9 mm
Blade Size 5 mm



OP-046-00
Infant Lid Speculum
Wire Ø 0.9 mm
Blade Size 4 mm



OP-050-09
Barraquer Lid Speculum (Infant)
Wire Ø 0.9 mm
Blade Size 9 mm



Cook Eye Speculum

OP-060-08
Infant
Overall Length 52 mm, Blade Size 8 mm

OP-060-11
Pediatric
Overall Length 55 mm, Blade Size 11 mm

OP-060-15
Adult
Overall Length 55 mm, Blade Size 15 mm



Eye Speculum
Lidsperrer
Blefarostatos
Blépharostats
Blefarostati



Murdoch Eye Speculum
OP-064-12
Overall Length 55 mm
Blade Size 12 mm
OP-064-15
Overall Length 57 mm
Blade Size 15 mm



OP-070-15
Mellinger Eye Speculum
Overall Length 57 mm
Blade Size 15 mm



OP-072-02
Bangerter Eye Speculum
Overall Length 55 mm With Locking Screw
Blade Size 15 mm



Williams Eye Speculum
OP-074-11
Overall Length 69 mm, With Locking Screw
Blade Size 11 mm
OP-074-15
Overall Length 86 mm, With Locking Screw
Blade Size 15 mm

Eye Speculum
Lidsperrer
Blefarostatos
Blépharostats
Blefarostati

OP

OPHTHALMIC SURGERY INSTRUMENTS



OP-076-16
Lancaster Eye Speculum
Overall Length 69 mm, Adjustable Opening
Blade Size 16 mm



OP-078-00
Lester-Burch Eye Speculum
Overall Length 82 mm, Adjustable Opening
Blade Size 21 mm

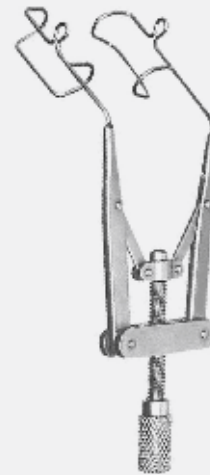

OP-081-15
Tanna-Lieberman Eye Speculum
Overall Length 86 mm, Adjustable Opening
Blade Size 15 mm

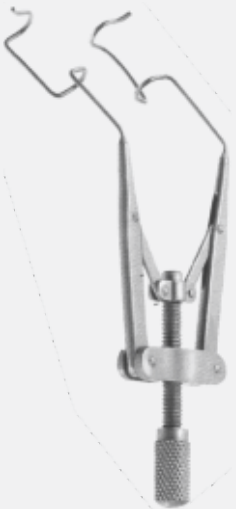

Lieberman Eye Speculum
OP-083-10
Pediatric
Overall Length 73 mm, Adjustable Opening
Blade Size 10 mm



OP-083-15 A
Lieberman Eye Speculum
With Aspirating Ports Overall Length 86 mm
Adjustable Opening Blade Size 15 mm



OP-085-15
Lieberman Eye Speculum
Overall Length 86 mm Adjustable Opening
Blade Size 15 mm

OP-083-15
Adult
Overall Length 86 mm, Adjustable Opening
Blade Size 15 mm

Eye Speculum
Lidsperrer
Blefarostatos
Blépharostats
Blefarostati

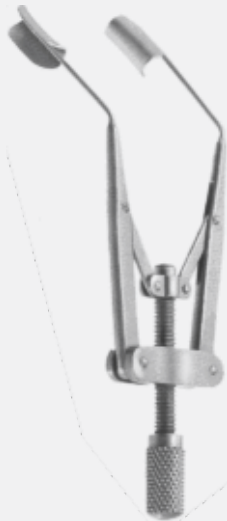

Lieberman Eye Speculum
(Solid Blades)

OP-087-10

Pediatric
Overall Length 73 mm, Adjustable Opening
Blade Size 10 mm

OP-087-15

Adult
Overall Length 86 mm, Adjustable Opening
Blade Size 15 mm



OP-089-15

Double X-K Wire Eye Speculum

Overall Length 86 mm, Adjustable Opening
Blade Size 15 mm



OP-089-15 A

Double X-K Wire Eye Speculum

With Aspirating Ports Overall Length
86 mm, Adjustable Opening
Blade Size 15 mm



Castroviejo Eye Speculum

OP-091-14

Overall Length 75 mm
Adjustable Opening, 14 mm

OP-091-16

Overall Length 82 mm
Adjustable Opening, 16 mm



OP-095-04

Saunders Eye Speculum

For Premature Infants Overall Length 35 mm
With Locking Thumb Screw Blade Size 4 mm

Scleral Fixation Ring
Scleral Fixation Ring
Anillo de fijación escleral
Anneau de fixation scléral
Sclerale Fixation Anello

OP

OPHTHALMIC SURGERY INSTRUMENTS

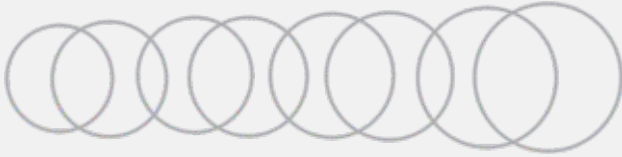

OP-100-00

Flieringa Scleral Fixation Ring

Set of 9 From OP-100-14 up to OP-100-22



OP-100-14
14 mm



OP-100-15
15 mm



OP-100-16
16 mm



OP-100-17
17 mm



OP-100-18
18 mm



OP-100-19
19 mm



OP-100-20
20 mm



OP-100-21
21 mm



OP-100-22
22 mm



McNeill-Goldman Scleral Fixation Ring

OP-111-15

Small, Ø 15 mm

OP-111-16

Medium Ø 16 mm

OP-111-17

Medium Ø 17 mm

Depressors, Eyelid Retractors
Depressors, Augenlid Wundhaken
Depresores, Retractor de párpados
Dépresseurs, Écarteur de paupières
Depressore, Palpebra Divaricatore



OP-151-01
Gass Scleral Marker
1.5 mm Marking Tip



Schepens Scleral Depressor

OP-153-01

Tip Width 7 mm Thimble Ø 15 mm Tapered to Ø 13 mm

OP-153-02

Tip Width 7 mm Thimble Ø 16 mm Tapered to Ø 14 mm

OP-153-03

Tip Width 7 mm Thimble Ø 17 mm Tapered to Ø 15 mm



Teardrop Shaped
Tip of 2.5 mm



Bar Shaped
Tip 6 mm Wide

OP-160-14
Schocket Scleral Depressor
Double End With Clip
Overall Length 14 cm (5 1/2")



OP-163-00
Gonnin Amsler Marker
Measuring Range 7 - 23 mm With 1 mm
Increments
Overall Length 13 cm (5 1/4")



OP-171-15
Schepens Orbital Retractor
Blade Size 14 x 56 mm With 4.5 mm Wide Notch
Overall Length 15 cm (6")

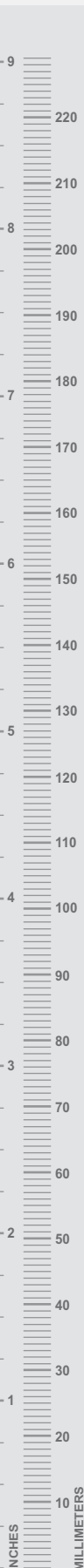

Eyelid Retractors
Augenlid Wundhaken
Retractor de párpados
Écarteur de paupières
Palpebra Divaricatore



Sauter Orbital Spatula
Overall Length 14 cm (5 ½")

OP-172-01
Blade Size 22 x 13 mm

OP-172-02
Blade Size 22 x 16 mm

OP-172-03
Blade Size 22 x 19 mm



Jaffe Wire Lid Retractor (Pair)

OP-173-13
Blade Width 13 mm

OP-173-15
Blade Width 15 mm



Desmarres Lid Retractor
Overall Length 13 cm (5")



OP-175-11
Thin Solid Blades
Fig. 0, 11 mm



OP-175-13
Thin Solid Blades
Fig. 1, 13 mm



OP-175-15
Thin Solid Blades
Fig. 2, 15 mm



OP-175-17
Thin Solid Blades
Fig. 3, 17 mm



Scleral Shield
OP-180-01
20 x 28 mm, Small (Pair)



OP-180-02
22 x 30 mm, Large (Pair)



Eyelid Retractors
Augenlid Wundhaken
Retractor de párpados
Écarteur de paupières
Palpebra Divaricatore



OP-192-11
Jaeger Lid Plate
20 x 35 / 24 x 35
Overall Length 11 cm (4 1/4")



OP-197-14
Wright Fascia Needle
Oval Hole, 1 x 6 mm
Overall Length 14 cm (5 1/2")



OP-199-14
Wills Cautery
With Copper Ball Ø 12 mm
Overall Length 14 cm (5 1/2")



OP-201-12
Walton Conjunctiva Retractor
Thin Solid Blade, 6 mm
Overall Length 12.5 cm (5")



Helveston Tissue Retractor
Thin Curved Blade
Overall Length 12.5 cm (5")



OP-211-07
"Barbie"
Blade Width 7 mm



OP-211-09
"Big Barbie"
Blade Width 9 mm



OP-211-11
"Great Big Barbie"
Blade Width 11 mm

Eyelid Retractors
Augenlid Wundhaken
Retractor de párpados
Écarteur de paupières
Palpebra Divaricatore

OP

OPHTHALMIC SURGERY INSTRUMENTS



OP-220-00
Stevenson Lacrimal Sac Retractor
3 x 3 Blunt Prongs, Adjustable Opening
Overall Length 85 mm



OP-222-00
Stevenson Lacrimal Sac Retractor
Solid Blades With Serrated Edge Adjustable
Opening Blade Size 13 mm
Overall Length 85 mm



OP-226-00
Agricola Lacrimal Sac Retractor
3 x 3 Blunt Prongs
Overall Length 14 mm



Keratome
Keratome
Queratomos
Kératotomes
Cheratomo



Dastoor Gouge & Lacrimal Sac Dissector
Overall Length 13 cm (5 1/4")

OP-228-01

With Sharp Gouge and Sharp Dissector

OP-228-02

With Sharp Gouge and Blunt Dissector



Bonn Scleral Knife

Rounded Tip
Overall Length 12 cm (4 3/4")

OP-239-40

Angled, 4 mm Wide Tip

OP-239-70

Angled, 7 mm Wide Tip



Jaeger Keratome
Overall Length 13 cm (5")



OP-240-01

Straight, Fig. 1
8.0 mm x 9.5 mm



OP-240-02

Straight, Fig. 2
9.5 mm x 11.0 mm



OP-240-03

Straight, Fig. 3
11.0 mm x 12.5 mm



OP-241-01

Angled, Fig. 1
8.0 mm x 9.5 mm



OP-241-02

Angled, Fig. 2
9.5 mm x 11.0 mm



OP-241-03

Angled, Fig. 3
11.0 mm x 12.5 mm

Corneal Knives
Hornhaut-Messer
Cuchillos corneales
Couteaux corneé
Coltelli corneali



OP-250-11

Tooke Corneal Knife

Straight, Blade Size 3 x 18 mm Smooth Blade
Overall Length 11 cm (4 1/4")



OP-251-01

Fig. 1, Blade Size 5.5 mm x 2.5 mm

OP-251-02

Fig. 2, Blade Size 4.5 mm x 2.0 mm

Kuhnt Corneal Scarifier

Overall Length 11 cm (4 1/4")



OP-253-12

DLEK Corneal Dissector

12 mm Long x 3 mm Wide With Semi-Sharp Spatulated Tip
Overall Length 12 cm (4 3/4")



OP-255-12

DLEK Corneal Dissector

12 mm Long x 3 mm Wide With Semi-Sharp Spatulated Tip
Overall Length 12 cm (4 3/4")

Corneal Knives
Hornhaut-Messer
Cuchillos corneales
Couteaux cornée
Cotelli corneali



OP-256-01

Fig. 1, 1.5 x 25 mm



OP-256-02

Fig. 2, 1.7 x 27 mm



OP-256-03

Fig. 3, 2 x 30 mm



OP-256-04

Fig. 4, 2.3 x 33 mm



OP-256-05

Fig. 1, 2.5 x 35 mm

Graefe Cataract Knife

Straight Blade and With Sharp Cutting Edge
Overall Length 12 cm (4 3/4")



OP-257-05

Fig. 1, 5 mm

OP-257-06

Fig. 2, 6 mm

OP-257-07

Fig. 3, 7 mm



OP-258-12

Straight, Blade Size 2.4 mm
Wide x 4.5 mm Long Blade



OP-259-12

Curved, Blade Size 2.4 mm
Wide x 4.5 mm Long Blade



Walter Cataract Needle

Overall Length 12 cm (4 3/4")

Ziegler Iris Knife

Overall Length 12 cm (4 3/4")

Corneal Knives
Hornhaut-Messer
Cuchillos corneales
Couteaux cornée
Coitelli corneali

OP

OPHTHALMIC SURGERY INSTRUMENTS



OP-260-12

Gills Corneal Knife

Straight, Rounded Cutting Edge Blade Size 3 mm
Overall Length 12.5 cm (5")



OP-261-12

Gills Corneal Knife

Slightly Curved, Rounded Cutting Edge Blade Size 3 mm
Overall Length 12.5 cm (5")



OP-263-12

Paufigue Graft Knife

Blade Size 1.6 mm x 1.75 mm Angled Cutting Edge
Overall Length 12 cm (4 3/4")



OP-265-12

Fukasaku Hockey Knife

3 mm Sharp Front Edge 6 mm Semi Sharp Bottom Edge
Overall Length 12 cm (4 3/4")

Corneal Knives
Hornhaut-Messer
Cuchillos corneales
Couteaux cornée
Cotelli corneali



OP-266-11
Barkan Goniotomy Knife
Blade Size 2.5 mm Long Blade
Overall Length 11.5 cm (4 1/2")

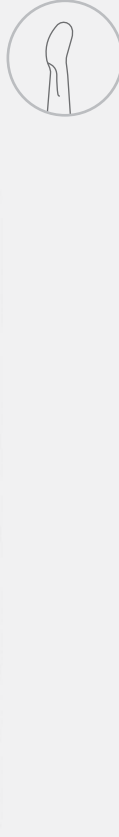

OP-268-01
Micro Round Viscocanalostomy Knife
1.0 mm Rounded Sharp Cutting Edge
Overall Length 11.5 cm (4 1/2")

Gouges and Spuds
Hohlmeißel und meißel
Gubias para Cinceles
Gouges et Ciseaux-burins
Sgorbie e Scalpelli

OP

OPHTHALMIC SURGERY INSTRUMENTS



OP-271-12

Golf Club Foreign Body Spud

Blade Size 2 x 0.8 mm Small Golf Club Shaped Tip
With Sharp Edge
Overall Length 12 cm (4 3/4")



OP-273-12

Francis Foreign Body Spud

Blade Size 2 x 0.8 mm Flag Shaped Tip With Sharp Edge
Overall Length 12 cm (4 3/4")



OP-275-11

Ellis Foreign Body Spud

Light Curved 1.0 mm Rounded Tip
Overall Length 11 cm (4 1/4")



OP-276-12

Walton Foreign Body Gouge

1.4 mm Rounded Tip
Overall Length 12.5 cm (5")

Gouges and Spuds
Hohlmeißel und meißel
Gubias para Cinceles
Gouges et Ciseaux-burins
Sgorbie e Scalpelli

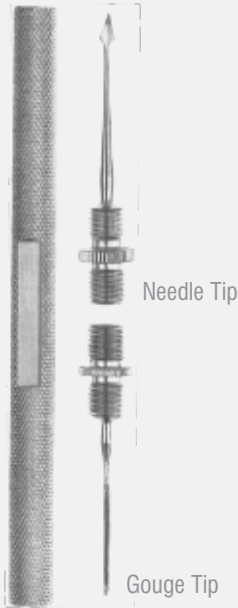

OP-280-18

Dix Foreign Spud & Gouge

3 X 5 mm Needle Tip On One Side 1.7 X 15 mm
Gouge Tip On Other Side In Reversible Handle
Overall Length 18 cm (7")



OP-283-11

Wills Eye Hospital Foreign Body Spud & Burr

Delicate Curved
11 cm (4 1/4")



OP-285-00

Arruga Micro Burr

1.0 mm Round Burr
Overall Length 12 cm (4 3/4")

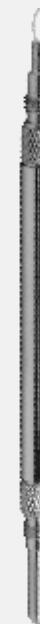

OP-291-11

Foreign Body Eye Magnet and Loop

Overall Length 11 cm (4 1/4")

Diamond Knives
Diamantmesser
Bisturi de diamante
Couteaux de diamant
Coltelli di diamanti

OP

OPHTHALMIC SURGERY INSTRUMENTS



OP-300-12

6-Facet Blade for Bi-directional Cutting Pre-calibrated Depth Settings of 0.6 mm

LRI Diamond Step Knife
Overall Length 12 cm (4 3/4")



OP-302-12

6-Facet Blade for Bi-directional Cutting Pre-calibrated Depth Settings of 0.5 mm, 0.55 mm and 0.6 mm

LRI Diamond Micrometer Knife
Overall Length 12 cm (4 3/4")



OP-304-12

6-Facet Blade for Bi-directional Cutting 0 to 1.5 mm Blade Extension in 10 Micron Increments

LRI Diamond Micrometer Knife
Overall Length 12 cm (4 3/4")



Diamond Knives
 Diamantmesser
 Bisturi de diamante
 Couteaux de diamant
 Coltelli di diamanti

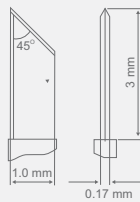

OP-305-11
 Double Vertical and 45° Cutting Edge Each Depth Can Be Adjusted Without Steps The Scale is Divided Each Hundredth Millimeter

AK Diamond Knife
 Overall Length 11 cm (4 1/4")

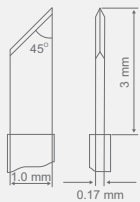

OP-311-01
 Single 1 mm Wide 45° Cutting Edge Each Depth Can Be Adjusted Without Steps The Scale is Divided Each Hundredth Millimeter

Diamond Micrometer Knife
 Overall Length 13 cm (5")

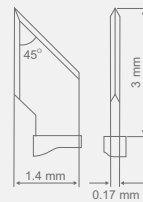

OP-311-02
 Double Vertical and 45° Cutting Edge Each Depth Can Be Adjusted Without Steps The Scale is Divided Each Hundredth Millimeter

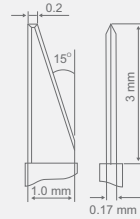

OP-311-03
 Triple Vertical and 15° Cutting Edge Each Depth Can Be Adjusted Without Steps The Scale is Divided Each Hundredth Millimeter



Diamond Knives
Diamantmesser
Bisturi de diamante
Couteaux de diamant
Coltelli di diamanti

OP

OPHTHALMIC SURGERY INSTRUMENTS

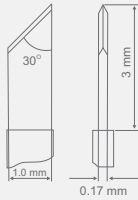

OP-316-01
Single 1 mm Wide
30° Cutting Edge

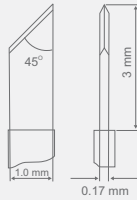

OP-316-02
Single 1 mm Wide
45° Cutting Edge

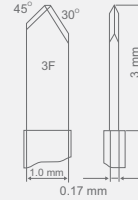

OP-316-03
Single 1 mm Wide
Tri-Facet Cutting Edge

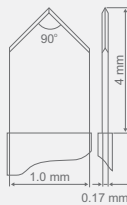

OP-316-04
1 mm Wide Spear
Shaped Cutting Edge

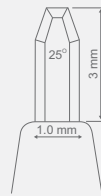

OP-316-05
1 mm Wide
10-Facet Cutting Edge

Diamond Knife
Overall Length 12.5 cm (5")



Diamond Knives
 Diamantmesser
 Bisturi de diamante
 Couteaux de diamant
 Coltelli di diamanti

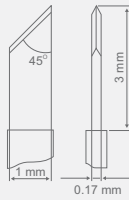

OP-320-01

Single 45° Cutting Edge 1.0 mm Wide
 With Adjustable Cutting
 Depth of 0 / 0.3 / 0.4 / 0.5 / 0.6 /
 0.8 / 1.0 / 2.5 mm

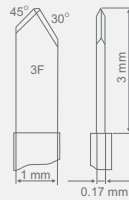

OP-320-02

Trifacet Cutting Edge 1.0 mm Wide
 With Adjustable Cutting
 Depth of 0 / 0.3 / 0.4 / 0.5 / 0.6 /
 0.8 / 1.0 / 2.5 mm

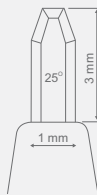

OP-320-03

10-Facet Cutting Edge 1.0 mm Wide
 With Adjustable Cutting
 Depth of 0.15 / 0.2 / 0.25 / 0.3 /
 0.37 / 0.5 / 4.0 mm

Diamond Step Knife
 Overall Length 12.5 cm (5")

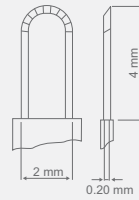

OP-331-25

Crescent Shaped 9-Edge
 Vertical Blade 2.0 mm Wide
 Angled



Crescent Diamond Knife
 Overall Length 11.5 cm (4 1/2")



Diamond Knives
Diamantmesser
Bisturi de diamante
Couteaux de diamant
Coltelli di diamanti

OP

OPHTHALMIC SURGERY INSTRUMENTS

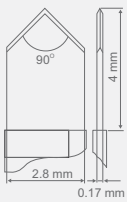

OP-340-28
Straight, 2.8 mm
Spear Shaped Cutting
Edge

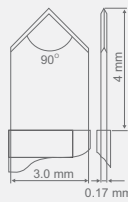

OP-340-30
Straight, 3.0 mm
Spear Shaped Cutting
Edge

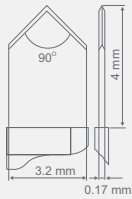

OP-340-32
Straight, 3.2 mm
Spear Shaped Cutting
Edge

Diamond Phaco Knife
Straight, Spear Shaped
Overall Length 13 cm (5")

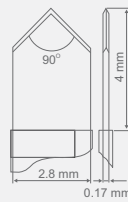
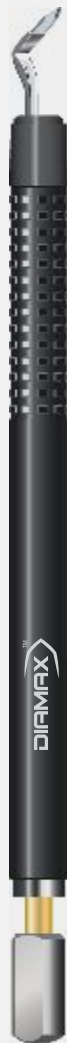

OP-341-28
Angled, 2.8 mm
Spear Shaped Cutting
Edge

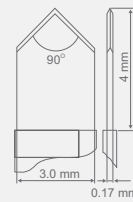

OP-341-30
Angled, 3.0 mm
Spear Shaped Cutting
Edge

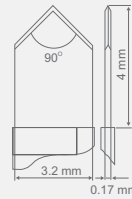

OP-341-32
Angled, 3.2 mm
Spear Shaped Cutting
Edge

Diamond Phaco Knife
Angled, Spear Shaped
Overall Length 13 cm (5")



Diamond Knives
Diamantmesser
Bisturi de diamante
Couteaux de diamant
Coltelli di diamanti

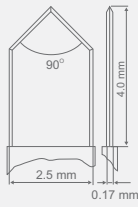

OP-351-25
Angled, 2.5 mm
Spear Shaped 4 - Sided
Cutting Edge

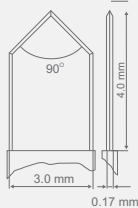

OP-351-30
Angled, 3.0 mm
Spear Shaped 4 - Sided
Cutting Edge

Diamond Phaco Knife
Overall Length 13 cm (5")

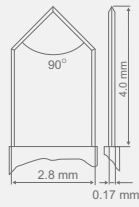

OP-351-28
Angled, 2.8 mm
Spear Shaped 4 - Sided
Cutting Edge

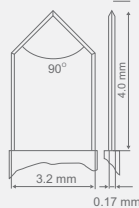

OP-351-32
Angled, 3.2 mm
Spear Shaped 4 - Sided
Cutting Edge

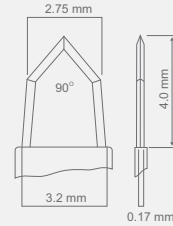

OP-355-27
Angled, 2.75 / 3.2 mm Trapezoid
Shaped 4 - Sided Cutting Edge

Diamond Phaco Knife
Overall Length 12 cm (4 3/4")



Diamond Knives
Diamantmesser
Bisturi de diamante
Couteaux de diamant
Cottelli di diamanti

OP

OPHTHALMIC SURGERY INSTRUMENTS

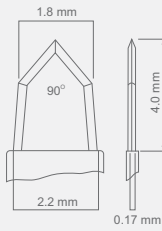

OP-357-18

Angled, 1.8 / 2.2 mm Trapezoid Shaped 4 - Sided Cutting Edge

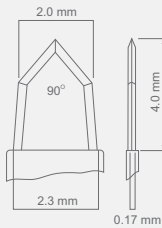

OP-357-20

Angled, 2.0 / 2.3 mm Trapezoid Shaped 4 - Sided Cutting Edge

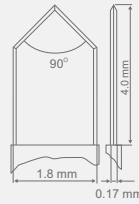

OP-359-18

Angled, 1.8 mm Spear Shaped 4 - Sided Cutting Edge

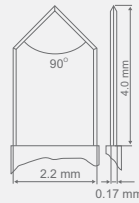

OP-359-22

Angled, 2.2 mm Spear Shaped 4 - Sided Cutting Edge

MICS Diamond Knife
Overall Length 12 cm (4 3/4")

MICS Diamond Knife
Overall Length 13 cm (5")



Trephines
Trephinen
Trépanos
Tréfans
Trepani



OP-370-10

Ø 1.0 mm

OP-370-15

Ø 1.5 mm

OP-370-20

Ø 2.0 mm

Elliot Scleral Trephine Blade
3.5 cm (1 1/2")



OP-370-90

Elliot Trephine Handle
4.5 cm (1 3/4")



OP-381-08

Ø 8 mm

OP-381-09

Ø 9 mm

OP-381-10

Ø 10 mm

Camellin LASEK Trephine
270° Semi-Sharp Edge 90° Cut Out for Flap Hinge
Overall Length 12 cm (4 3/4")



OP-385-08

Ø 8 mm Trephine and Ø 8.5 mm Well

OP-385-09

Ø 9 mm Trephine and Ø 9.5 mm Well

OP-385-10

Ø 10 mm Trephine and Ø 10.5 mm Well

Camellin LASEK Trephine & Alcohol Retaining Well
Overall Length 12.5 cm (5")

Ophthalmic Punches
Augenheilkunde Stanze
Punzones de oftalmología
Poinçons ophtalmiques
Punzoni oftalmici

OP

OPHTHALMIC SURGERY INSTRUMENTS

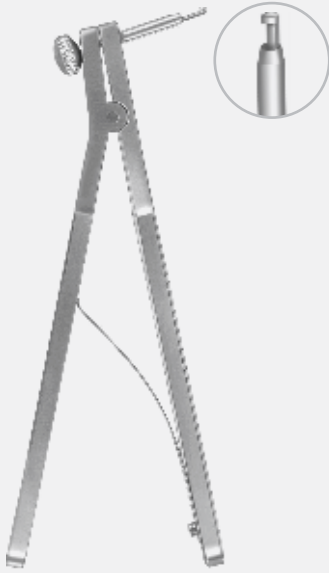

OP-391-00

Gass Corneoscleral Punch

With 360° Rotatable Cutting Tip 1.5 mm x 0.75 mm Bite
Overall Length 8.5 cm (3 1/2")



OP-395-00

Luntz-Dodick Trabeculectomy Punch

With 360° Rotatable Cutting Tip 1 mm x 0.5 mm Bite
Overall Length 11.5 cm (4 1/2")



OP-397-00

Kelly Descemet's Membrane Punch

For Glaucoma 19 Gauge / 1.0 mm 0.9 mm x 0.45 mm Bite
Overall Length 12.5 cm (5")

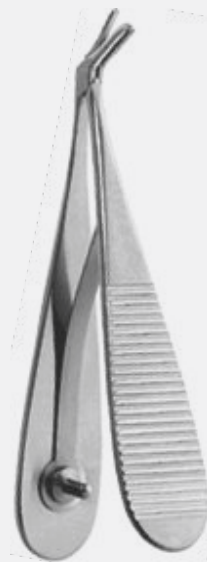

OP-399-00

Christensen Punctum Punch

For Opening Stenotic Punctum 1.0 mm Wide Tip
Overall Length 10 cm (4")

Trephines
Trephinen
Trépanos
Trépan
Trepani



Corneal Trephine Blade

<u>OP-400-01</u> Ø 6.0 mm	<u>OP-400-02</u> Ø 6.5 mm	<u>OP-400-03</u> Ø 6.75 mm	<u>OP-400-04</u> Ø 7.0 mm	<u>OP-400-05</u> Ø 7.25 mm	<u>OP-400-06</u> Ø 7.5 mm	<u>OP-400-07</u> Ø 7.75 mm	<u>OP-400-08</u> Ø 8.0 mm
<u>OP-400-09</u> Ø 8.25 mm	<u>OP-400-10</u> Ø 8.5 mm	<u>OP-400-11</u> Ø 8.75 mm	<u>OP-400-12</u> Ø 9.0 mm	<u>OP-400-13</u> Ø 9.5 mm	<u>OP-400-14</u> Ø 14.0 mm		



Corneal Trephine Handle

<u>OP-401-01</u> Ø 6.0 mm	<u>OP-401-02</u> Ø 6.5 mm	<u>OP-401-03</u> Ø 6.75 mm	<u>OP-401-04</u> Ø 7.0 mm	<u>OP-401-05</u> Ø 7.25 mm	<u>OP-401-06</u> Ø 7.5 mm	<u>OP-401-07</u> Ø 7.75 mm	<u>OP-401-08</u> Ø 8.0 mm
<u>OP-401-09</u> Ø 8.25 mm	<u>OP-401-10</u> Ø 8.5 mm	<u>OP-401-11</u> Ø 8.75 mm	<u>OP-401-12</u> Ø 9.0 mm	<u>OP-401-13</u> Ø 9.5 mm			

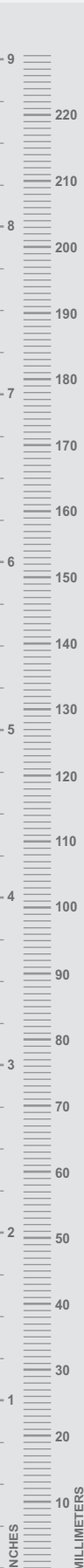

Cannulas
Kanülen
Cánulas
Canules
Cannule

OP

OPHTHALMIC SURGERY INSTRUMENTS



Lacrimal Cannula

OP-410-23

Malleable Tip
Straight, 23 G

OP-410-27

Malleable Tip
Straight, 27 G



Lacrimal Cannula

OP-411-23

Malleable Tip
Curved, 23 G

OP-411-27

Malleable Tip
Curved, 27 G



**OP-412-23
McIntyre Lacrimal
Cannula**

Straight, 23 G,
Blunt Tip Dual
0.3 mm Side Ports



**OP-413-23
McIntyre Lacrimal
Cannula**

Curved, 23 G,
Blunt Tip Dual
0.3 mm Side Ports



**OP-415-23
West Lacrimal Cannula**

Blunt Tip, 23 G
0.3 mm Side Port



**OP-417-27
DALK Air Injection
Cannula**

Flattened, Vaulted
0.2 mm Posterior Port
Near Tip, 27 G



**OP-419-27
Rosenwasser DALK Cannula**

Flattened "Cobra Shaped"
Tip 0.2 mm Posterior Port
27 G



Top View

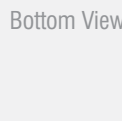

Bottom View



Air Injection Cannula



OP-421-27
Angled at
5 mm, 27 G



OP-421-30
Angled at
5 mm, 30 G



OP-423-27
Angled at
7 mm, 27 G



OP-423-30
Angled at
7 mm, 30 G



Cannulas
Kanülen
Cánulas
Canules
Cannule

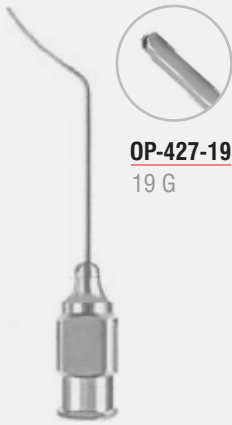

OP-427-19
19 G

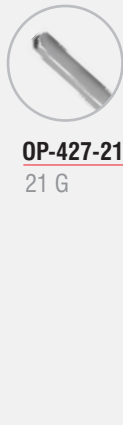

OP-427-21
21 G



OP-429-19
10 mm, 19 G

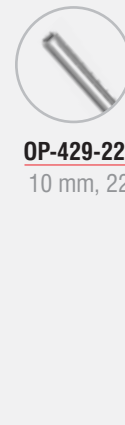

OP-429-22
10 mm, 22 G

Randolph Cyclodialysis Cannula
Flat Tip Angled at 13 mm

Viscoelastic Aspirating Cannula
Round Tip Angled at 10 mm



OP-433-25
Troutman Olive Tip Cannula
Delicate, 25 G



OP-437-27
Flat Tip, Angled at 7 mm
27 G

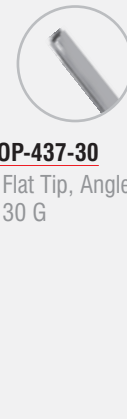

OP-437-30
Flat Tip, Angled at 7 mm
30 G

Rainin Air Injection Cannula
Flat Tip, Angled at 7 mm, 27 G

Cannulas
Kanülen
Cánulas
Canules
Cannule

OP

OPHTHALMIC SURGERY INSTRUMENTS



OP-439-25
LASEK Alcohol Cannula
Angled at 10 mm
Delicate Olive Shaped Tip, 25 G



OP-441-19
Stevens Sub Tenon's Anesthesia Cannula
Gently Curved, Flat Tip, 19 G



OP-443-23
Atkinson Retrobulbar Needle
Straight, 35 mm Long Sharp Tip 23 G



OP-445-23
Corbin Sub Tenon's Anesthesia Cannula
Smooth Rounded Tip With 0.3 mm
Side Port 23 G



OP-447-24
Fukasaku Sub Tenon's Anesthesia Cannula
Gently Curved Smooth Tip, 24 G



Cannulas
Kanülen
Cánulas
Canules
Cannule



OP-451-23

Simcoe Irrigating - Aspirating Cannula

15 mm Long With 0.3 mm Aspirating Side Port, 23 G
Aspiration Through Tubing Hub and Irrigation Through
Luer-Lock Hub

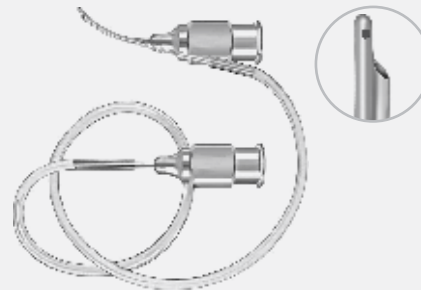

OP-453-23

Simcoe (Reversed) Irrigating - Aspirating Cannula

15 mm Long With 0.3 mm Aspirating Side Port, 23 G
Aspiration Through Luer-Lock Hub and Irrigation Through
Tubing Hub



OP-455-23

Simcoe Irrigating - Aspirating Cannula

Curved Right, 23 G
U-Shaped, With 0.3 mm Anterior Aspiration Port
Aspiration Through Tubing Hub and Irrigation
Through Luer-Lock Hub



OP-457-23

Simcoe Irrigating - Aspirating Cannula

Curved Left, 23 G
U-Shaped, With 0.3 mm Anterior Aspiration Port
Aspiration Through Tubing Hub and Irrigation
Through Luer-Lock Hub

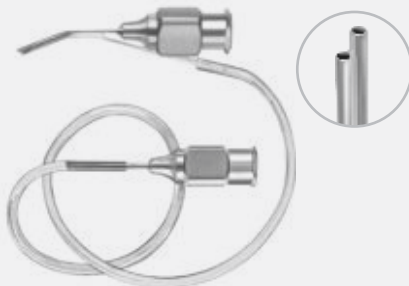

OP-459-23

Gills Irrigating - Aspirating Cannula

23 G, Angled Tip, Front Openings
With 0.5 mm Recessed Irrigating Port



OP-462-22

Kelman Cystotome

23 G, Sharp Cutting Edge With Sharp Point

Cannulas
Kanülen
Cánulas
Canules
Cannule



OP-463-22
Kraiz Cystotome
22 G, Sharp Cutting Edge With Sharp Point



OP-465-23
McIntyre Cystotome
23 G, Angled at 10 mm, Sharp Point



Jansen Capsule Polisher Cannula
OP-467-23
23 G, Gently Curved Shaft With Lower Half Diamond Dusted Olive Tip

OP-467-25
25 G, Gently Curved Shaft With Lower Half Diamond Dusted Olive Tip



OP-471-19
Bishop-Harmon Anterior Chamber Irrigator
23 G, Angled Shaft With Flat Blunt Tip Including Adapter and Blue Silicone Bulb



OP-475-25
Hydrodissection Cannula
Angled at 8 mm, Flat Tip, 25 G



OP-477-26
Seeley Hydrodissection Cannula
Angled at 12 mm, Flat Tip, 25 G



Cannulas
Kanülen
Cánulas
Canules
Cannule



OP-481-23
23 G



OP-481-27
27 G



OP-481-30
30 G

Knolle Anterior Chamber Irrigation Cannula
Angled at 2 mm With Front Opening Tip



OP-485-27
Sauter Hydrodissection Cannula
Vertically Flattened Tip With Front Opening, 27 G



OP-487-19
Bracken Irrigation Cannula
Smooth Beveled Tip With Front Opening, 19 G



OP-489-23
Irrigation Cannula
Curved Shaft With Blunt Tip and Dual 0.4 mm Side Ports, 23 G

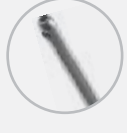

OP-491-23
Alio LASIK Irrigation Cannula
With One Front and Two Side Ports 23 G



OP-493-21
Irrigation Cannula
Curved Shaft With Blunt Tip and Dual 0.5 mm Side Ports, 21 G

Cannulas
Kanülen
Cánulas
Canules
Cannule

OP

OPHTHALMIC SURGERY INSTRUMENTS



OP-495-26
Spatulated LASIK Cannula
Flattened Spatula Shaped Tip, 26 G



OP-501-23
Fukasaku LASIK Cannula
Flattened Low Profile Tip With
Front Opening, 23 G



OP-503-25
Carter LASIK Cannula
Flattened Low Profile Tip With
Front Opening, 25 G



OP-507-25
Banaji LASIK Cannula
6 Irrigating Ports With Bullet Shaped Tip, 25 G

Cannulas
Kanülen
Cánulas
Canules
Cannule



OP-509-23
23 G



OP-509-25
25 G



Buratto LASIK Cannula
Slightly Flattened Tip With One Front and Two Side Ports

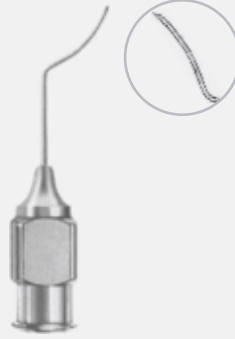

OP-511-25
Brierley LASIK Cannula
6 Irrigating Ports With Closed Spatula Shaped Tip, 25 G



OP-516-23
23 G



OP-516-26
26 G



OP-516-30
30 G

McIntyre Anterior Chamber Cannula
Straight, Smooth Blunt Tip With Front Opening

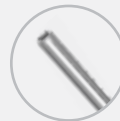

OP-517-23
23 G



OP-517-26
26 G



OP-517-30
30 G

McIntyre Anterior Chamber Cannula
Angled, Smooth Blunt Tip With Front Opening



OP-519-30
Gimbel Cortex Aspirating Cannula
Double Angled With Round Front Opening Tip, 30 G



OP-521-23
Simcoe Cortex Extractor
13 mm Curved Shaft With 0.3 mm Side Port, 23 G



OP-523-23
Simcoe Cortex Extractor
21 mm Curved Shaft With 0.4 mm Side Port, 23 G



OP-525-21
Simcoe Cortex Extractor
Smooth Closed Tip 21 mm Long Side Port, 23 G

Cannulas
Kanülen
Cánulas
Canules
Cannule

OP

OPHTHALMIC SURGERY INSTRUMENTS



OP-527-23
Charleux Cortex Extractor
Curved Shaft With Beveled Irrigation
Port 23 G

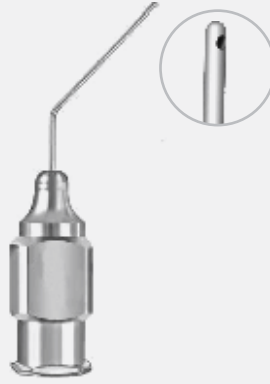

OP-527-25
De La O Aspirating Cannula
Angled at 12 mm With 0.3 mm
Side Port, 25 G



Gills Aspirating Cannula
Angled Shaft With Smooth Blunt Round Tip, 25 G



OP-529-05
5 mm Long Tip



OP-529-07
7 mm Long Tip



OP-529-08
8 mm Long Tip



OP-529-10
10 mm Long Tip



OP-531-23
Fukasaku Hydro-Chop Cannula
Vertically Flattened Tip, Dual Side Ports, 23 G



OP-532-27
Chang Hydrodissection Cannula
Flat Tip With Beveled Opening, 27 G



OP-533-23
Drews Irrigation Vectis
One Front and Two Backward
Opening Ports, 23 G

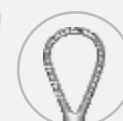

OP-535-20
Sheets Irrigation Vectis
Three Front Opening Ports, 20 G



Cannulas
Kanülen
Cánulas
Canules
Cannule



OP-537-23
Knolle-Pearce Irrigation Vectis
Three Front Opening Ports, 23 G



OP-539-25
Simcoe Irrigation Lens Nucleus Loop
Finely Serrated Tip With Two Front Opening Ports, Right, 25 G



OP-541-25
Simcoe Irrigation Lens Nucleus Loop
Finely Serrated Tip With Two Front Opening Ports, Left, 25 G



Alfonso Nucleus Irrigating Spoon
OP-542-25
2.5 mm Wide Spoon With Single 0.3 mm Front Opening Port

OP-542-40
4.0 mm Wide Spoon With Single 0.3 mm Front Opening Port

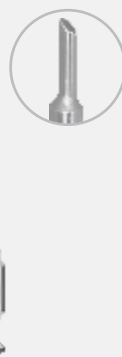

OP-543-22
Drof Infusion Cannula
18 Gauge Shaft With 22 Gauge 3 mm Long Tip

Cannulas
Kanülen
Cánulas
Canules
Cannule

OP

OPHTHALMIC SURGERY INSTRUMENTS



Heslin Infusion Cannula
Texture Tip



OP-545-23
23 G



OP-545-25
25 G



OP-547-22
Infusion Cannula
Self Retaining Tip
22 G



OP-549-01 T
Irrigation Handpiece
Titanium
For Bimanual Technique, 21 G, Dual 2 x 0.5 mm Side Ports
Overall Length 10.5 cm (4")



OP-549-02 T
Aspiration Handpiece
Titanium
For Bimanual Technique, 21 G, 2 x 0.5 mm Side Port
Overall Length 10.5 cm (4")

Ophthalmology Instruments
Ophthalmologie Instrumente
Oftalmología Instrumentos
Ophthalmologie Instrumente
Oftalmologia Strumenti



OP-550-00
Fig. 0, Ø 1.5 mm



OP-550-01
Fig. 1 Ø 1.75 mm



OP-550-02
Fig. 2, Ø 2.25 mm



OP-550-03
Fig. 3, Ø 2.5 mm



OP-550-04
Fig. 4, Ø 3.5 mm

Meyerhoefer Chalazion Curette
Overall Length 12.5 cm (5")



OP-552-10
Fig. 0
1 x 1.7 mm



OP-552-15
Fig. 1
1.5 x 2.5 mm



OP-552-20
Fig. 2
2.0 x 3.3 mm



OP-552-25
Fig. 3
2.5 x 4.0 mm



OP-552-30
Fig. 4
3.0 x 5.0 mm



OP-552-35
Fig. 5
3.5 x 5.7 mm

Hebra Chalazion Curette
Overall Length 12.5 cm (5")

Ophthalmology Instruments
Ophthalmologie Instrumente
Oftalmologia Instrumentos
Ophthalmologie Instruments
Oftalmologia Strumenti

OP

OPHTHALMIC SURGERY INSTRUMENTS



OP-571-12
Nightingale Capsule Polishing Curette
Semi-Sharp Posterior Edge Ø 1.75 mm Open Ring
Overall Length 12.5 cm (5")



OP-573-12
Shepherd Capsule Polishing Curette
Semi-Sharp Anterior & Posterior Edges Ø 1.75 mm Open Ring
Overall Length 12.5 cm (5")



OP-587-13
Blumenthal Conjunctiva Dissector
Ø 2.0 mm Blunt Disc Shaped Tip
Overall Length 13 cm (5")



OP-591-12
Buratto LASIK Flap Protector
12.0 mm Wide Blade
Overall Length 12.5 cm (5")

Ophthalmology Instruments
Ophthalmologie Instrumente
Oftalmología Instrumentos
Ophthalmologie Instrumente
Oftalmologia Strumenti



OP-594-11
Buratto LASIK Flap Protector
Double Ended With 12.0 mm Wide Blades Angled at 15°
Overall Length 11.5 cm (4 ½")



OP-597-11
Mannis-Buratto LASIK Flap Protector
Double Ended With 12.0 mm Wide Blades Angled at 45°
Overall Length 11.5 cm (4 ½")



OP-599-13
Rowen LASIK Flap Protector/Spatula
12.0 mm Wide Protector Blade and 8.0 mm Long Spatula Blade
Overall Length 13 cm (5")

Ophthalmology Instruments
Ophthalmologie Instrumente
 Oftalmologia Instrumentos
 Ophthalmologie Instruments
 Oftalmologia Strumenti

OP

OPHTHALMIC SURGERY INSTRUMENTS



OP-611-12
Sloane LASIK Micro Hoe
2.0 mm Wide Semi-Circular
Tip With Beveled Edges
Overall Length 12 cm (4 ¾")



OP-615-11
Sloane Epi Peeler
1 x 5 mm Spatula Shaped
Semi Sharp Tip Edge
Overall Length 11.5 cm (4 ½")

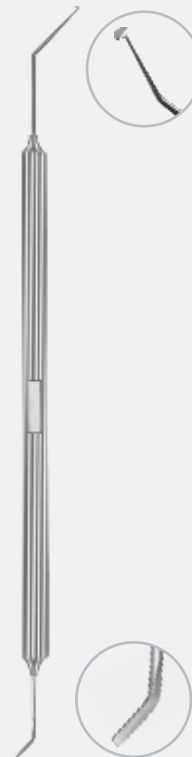

OP-619-13
Sloane LASIK Micro Hoe & Epi Peeler
2.0 mm Wide Semi-Circular Tip With Beveled Edges
1 x 5 mm Spatula Shaped Semi Sharp Tip Edge
Overall Length 13.5 cm (5 ¼")

Ophthalmology Instruments
Ophthalmologie Instrumente
Oftalmología Instrumentos
Ophthalmologie Instrumente
Oftalmologia Strumenti



OP-623-11
Sloane LASIK Epi-Dissector
7.0 mm Long Spatula Shaped Tip
With Semi-Sharp Edge
Overall Length 11.5 cm (4 1/2")



OP-627-12
Sloane LASIK Flap Repositor
Gently Curved Bi-Convex Spatulated Tip
With Beveled Smooth Edge
Overall Length 12 cm (4 3/4")



OP-629-01
DALK Corneal Dissector
12 mm Long Flat Vaulted Spatula
With Beveled Tip
Overall Length 12.5 cm (5")



OP-629-02
Rosenwasser DALK Trisector
10 mm Long Triangular Shaft With Spatula Shaped Tip
Overall Length 12.5 cm (5")



OP-629-03
Bonfadini DALK Spatula
Vaulted 1.0 mm Wide 8 mm Long Blade Spatula
Shaped Blade With Central Groove
Overall Length 12.5 cm (5")

Ophthalmology Instruments
Ophthalmologie Instrumente
Oftalmologia Instrumentos
Ophthalmologie Instruments
Oftalmologia Strumenti

OP

OPHTHALMIC SURGERY INSTRUMENTS



OP-629-14

Dastoor Pupil and Iris Repositor

Double Ended 1 mm Wide Notched Tip on
One Side and Spatula Shaped Tip on Other side
Overall Length 13 cm (5")



OP-630-01

Culler Iris Spatula

Straight 1 mm Wide and 28 mm
Long Spatula
Overall Length 13 cm (5")



OP-630-02

Culler Iris Spatula

Straight 2 mm Wide and 28 mm
Long Spatula
Overall Length 13 cm (5")

Ophthalmology Instruments
Ophthalmologie Instrumente
Oftalmología Instrumentos
Ophthalmologie Instruments
Oftalmologia Strumenti



OP-632-13
Wheeler Double-End Spatula
Double Ended Slightly Curved Spatula Shaped
Blades (2 x 33 mm Blade on One Side and
2 x 24 mm Blade on The Other Side)
Overall Length 13 cm (5")



Barraquer Iris Spatula
Overall Length 12 cm (4 3/4")

OP-635-01
Vaulted 0.25 mm Wide and 15.0 mm
Long Blade With Blunt Tip

OP-635-02
Vaulted 0.50 mm Wide and 15.0 mm
Long Blade With Blunt Tip



OP-637-12
Gimbel Nucleus Spatula
30° Angled Shaft, 9 mm Long Ø 0.25 mm
Round Blade
Overall Length 12.5 cm (5")

Ophthalmology Instruments
Ophthalmologie Instrumente
Oftalmologia Instrumentos
Ophtalmologie Instruments
Oftalmologia Strumenti

OP

OPHTHALMIC SURGERY INSTRUMENTS



OP-639-12

Escaf Nucleus Manipulator

With 1 mm Wide and 1.4 mm Long Tip
Angled at 45° - 13 mm Long from Bend
to Tip Shaft
Overall Length 12 cm (4 3/4")



OP-640-12

Knolle Nucleus Spatula

0.5 mm Wide, Flat Malleable Spatula
Overall Length 12.5 cm (5")



OP-643-01

OP-643-02

Koch Nucleus Spatula

Overall Length 11.5 cm (4 1/2")

OP-643-01

Slightly Curved 0.8 mm Wide Duckbill Shaped Tip

OP-643-02

Slightly Curved 0.8 mm Wide Duckbill Shaped Tip
With Notches

Ophthalmology Instruments
Ophthalmologie Instrumente
Oftalmología Instrumentos
Ophthalmologie Instrumente
Oftalmologia Strumenti



OP-645-11
Akahoshi Nucleus Sustainer
Ø 0.4 mm Ball Shaped Tip 1.8 mm
Angled With 10 mm Long Shaft
Overall Length 11.5 cm (4 ½")



OP-647-12
Escaf Nucleus Sustainer
Ø 0.5 mm Ball Shaped Tip With Inferior Textured
Surface 1.8 mm Angled With 10 mm Long Shaft
Overall Length 12 cm (4 ¾")



OP-649-01



OP-649-02

Lieberman Nucleus Manipulator
Overall Length 12 cm (4 ¾")

OP-649-01
1.5 mm Curved Right Tip With 10 mm
Long Shaft from Bend to Tip

OP-649-02
1.5 mm Curved Left Tip With 10 mm
Long Shaft from Bend to Tip

Ophthalmology Instruments
Ophthalmologie Instrumente
Oftalmologia Instrumentos
Ophtalmologie Instruments
Oftalmologia Strumenti

OP

OPHTHALMIC SURGERY INSTRUMENTS

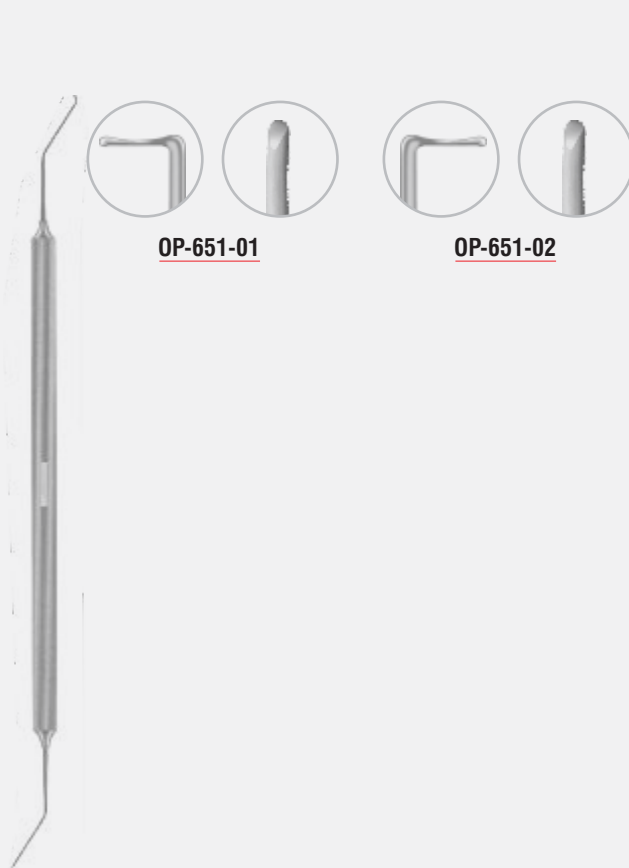

Lieberman Nucleus Manipulator and Spatula

Overall Length 14 cm (5 ½")

OP-651-01

1.5 mm Curved Right Tip With 10 mm Long Shaft from Bend to Tip on One Side and 1 mm Wide Spatula Shaped Tip on Other Side

OP-651-02

1.5 mm Curved Left Tip With 10 mm Long Shaft from Bend to Tip on One Side and 1 mm Wide Spatula Shaped Tip on Other Side



Fukasaku-Lieberman Nucleus Manipulator and Hook

Overall Length 13.5 cm (5 ¼")

OP-653-01

For Right Hand Use 3.5 mm Long Micro Finger Chopper on One Side & 1.25 Long Blunt Tip Hook With 0.8 mm Long Wedge Shaped Inferior Edge & Notch on Front Side on Other Side

OP-653-02

For Right Hand Use 3.5 mm Long Micro Finger Chopper on One Side & 1.25 Long Blunt Tip Hook With 0.8 mm Long Wedge Shaped Inferior Edge & Notch on Front Side on Other Side

Ophthalmology Instruments
Ophthalmologie Instrumente
Oftalmología Instrumentos
Ophthalmologie Instrumente
Oftalmologia Strumenti



OP-657-13
Masket Phaco Spatula
Combination of Ø 1 mm
Disc Shaped Spatula & 0.8 mm
Long Rosen Type Phaco Splitter Tip
Overall Length 13 cm (5")



Chang Phaco Chopper
Overall Length 13 cm (5")

OP-659-01

For Right Hand Use 3.5 mm Long Micro
Finger Chopper on One Side & 0.9 mm
Long Quick Chop Tip on Other Side

OP-659-02

For Left Hand Use 3.5 mm Long Micro Finger
Chopper on One Side & 0.9 mm Long Quick
Chop Tip on Other Side



OP-661-11
Minardi Phaco Chopper
30° Angled Shaft With 0.7 mm Long Quick Chop
Tip Angle to Tip Length of 10 mm
Overall Length 11.5 cm (4 ½")

Ophthalmology Instruments
Ophthalmologie Instrumente
Oftalmologia Instrumentos
Ophtalmologie Instruments
Oftalmologia Strumenti

OP

OPHTHALMIC SURGERY INSTRUMENTS



OP-663-13

Hwang Phaco Chopper

Double 1 mm Long Vertical Chopper On One Side and 1 mm Wide Blunt Chisel Tipped Spatula On Other Side, Angle to Tip Length of 10 mm on Both Sides
Overall Length 13.5 cm (5 ¼")



OP-665-11

Agarwal Karate Phaco Chopper

0.9 mm Long Tip With 0.6 mm Semi-Sharp Inferior Edge & Pointed Tip Angle to Tip Length of 11 mm
Overall Length 11.5 cm (4 ½")



OP-667-11

Chang Micro Finger Chopper

3.5 mm Long Curved Finger Shaped Tip With Defined Inner Edge for Horizontal Chopping, Angle to Tip Length of 10 mm
Overall Length 11.5 cm (4 ½")

Ophthalmology Instruments
Ophthalmologie Instrumente
Oftalmología Instrumentos
Ophthalmologie Instrumente
Oftalmologia Strumenti



OP-669-12
Brierley Nucleus Splitter
1 mm Long Splitter With Incision
Sealing Shaft Angle Tip Length of
12 mm
Overall Length 12 cm (4 3/4")



OP-670-15 **OP-670-20**

Dodick-Kammann Nucleus Chopper
Overall Length 12 cm (4 3/4")
OP-670-15
Straight Shaft With 1.5 mm Long Chopper
Tip For Bimanual Nucleus Division
OP-670-20
Straight Shaft With 2.0 mm Long Chopper
Tip For Bimanual Nucleus Division



OP-671-15 **OP-671-20**

Dodick-Kammann Nucleus Chopper
Overall Length 12 cm (4 3/4")
OP-671-15
Angled Shaft With 1.5 mm Long Chopper
Tip For Bimanual Nucleus Division, Angle Tip Length
of 12 mm
OP-671-20
Angled Shaft With 2.0 mm Long Chopper
Tip For Bimanual Nucleus Division, Angle Tip Length
of 12 mm

Ophthalmology Instruments
Ophthalmologie Instrumente
 Oftalmologia Instrumentos
 Ophtalmologie Instruments
 Oftalmologia Strumenti

OP

OPHTHALMIC SURGERY INSTRUMENTS



OP-673-12

Escaf Nucleus Divider

1.25 mm Long & 0.5 mm Wide Wedge Shaped Tip for Vertical Chopping
Overall Length 12 cm (4 3/4")



OP-675-12

Neuhann Nucleus Divider

0.5 mm Wide Strongly Curved Spatula Shaped Tip
Overall Length 12 cm (4 3/4")

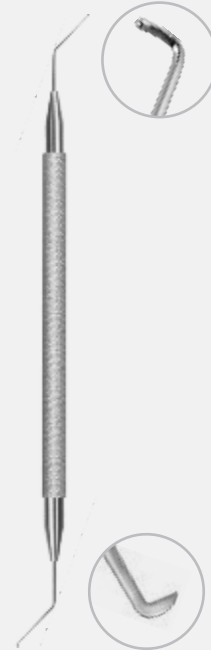

OP-677-11

Nagahara Nucleus Lens Spatula & Chopper

Chopper With 1.5 mm Long Tip With 0.9 mm Long and Blunt Tip on One Side and Spatula With Flat Inferior Edge on Other Side Angle to Tip Length of 10 mm on Both Sides
Overall Length 11 cm (4 1/4")



OP-678-11

Nagahara Nucleus Chopper

Chopper With 1.5 mm Long Tip With 0.9 mm Long and Blunt Tip Angle to Tip Length of 10 mm
Overall Length 11 cm (4 1/4")



OP-679-11

Fukasaku Snapper Hook

1.25 mm Long Blunt Tip With 0.8 mm Long Wedge Shaped Inferior Edge Angle to Tip Length of 9 mm
Overall Length 11.5 cm (4 1/2")

Ophthalmology Instruments
Ophthalmologie Instrumente
Oftalmología Instrumentos
Ophthalmologie Instrumente
Oftalmologia Strumenti

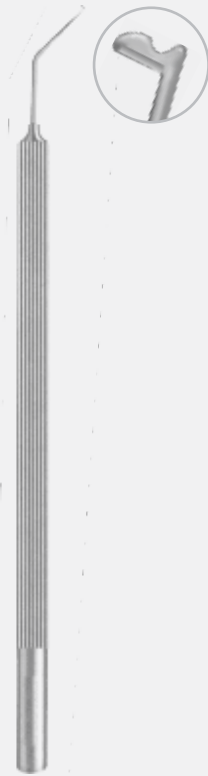

OP-681-11
Fukasaku Snapper Hook & Small Pupil
1.25 mm Long Blunt Tip With 0.8 mm Long Wedge Shaped Inferior Edge & Notch on Front Angle to Tip Length of 9 mm
Overall Length 11.5 cm (4 1/2")

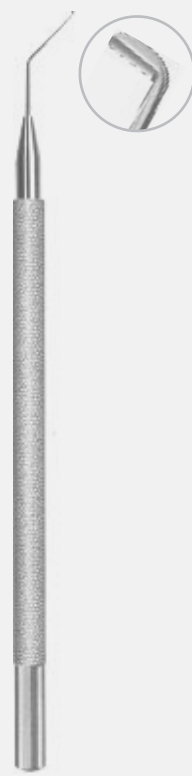

OP-683-11
Rosen Phaco Splitter
0.8 mm Long Sharp 45° Inferior Cutting Edge Angle to Tip Length of 9 mm
Overall Length 11.5 cm (4 1/2")



OP-685-11
Rosen Phaco Splitter
0.8 mm Long Wedge Shaped 60° Inferior Cutting Edge With Blunt Tip Angle to Tip Length of 9 mm
Overall Length 11.5 cm (4 1/2")



OP-687-13
Rowen Phaco Spatula
Double Ended With Angled Shafts, 9 mm from Angle Tip For Rosen Chopper on One Side and 7 mm Angle To Tip for Bechert Type Nucleus Rotator on Other Side
Overall Length 13 cm (5")

Ophthalmology Instruments
Ophthalmologie Instrumente
Ofthalmologia Instrumentos
Ophtalmologie Instruments
Ofthalmologia Strumenti

OP

OPHTHALMIC SURGERY INSTRUMENTS



OP-689-01

Bechert Nucleus Rotator

0.78 mm Horizontally Forked Tip With
Angled to Tip Length of 7 mm
Overall Length 11.5 cm (4 ½")



OP-689-02

Jaffe-Bechert Nucleus Rotator

0.78 mm Horizontally Forked Tip With
Angled to Tip Length of 9 mm
Overall Length 11.5 cm (4 ½")



OP-691-11

Clayman Nucleus Rotator

0.5 mm Wide Flat Spatula With V-Notched Tip
Angled to Tip Length of 10 mm
Overall Length 12 cm (4 ¾")



Ophthalmology Instruments
Ophthalmologie Instrumente
Oftalmología Instrumentos
Ophthalmologie Instrumente
Oftalmologia Strumenti



OP-693-11
Drysdale Nucleus Manipulator
0.8 mm x 2.4 mm Paddle
Shaped Tip With Angle to Tip
Length of 10 mm
Overall Length 11 cm (4 1/4")



OP-695-11
Pisacano Nucleus Rotator
1 mm Horizontal Flat Disc
Shaped Tip With Angled to
Tip Length of 11 mm
Overall Length 11.5 cm (4 1/2")

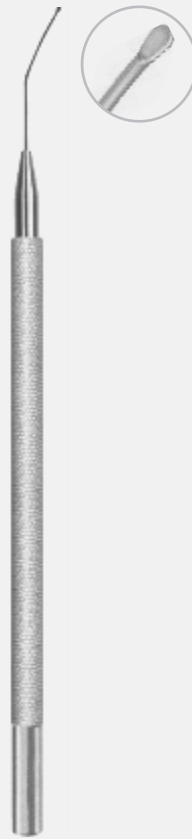

OP-697-11
Pisacano Nucleus Rotator
1 mm Vertical Flat Disc Shaped
Tip With Angled to Tip Length
of 11 mm
Overall Length 11.5 cm (4 1/2")

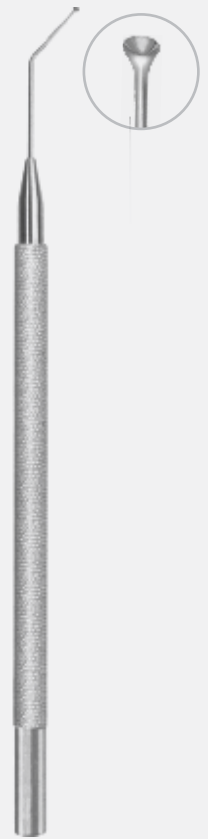

OP-699-11
Siepser Endocapsular Controller
Ø 0.7 mm Trumpet Shaped Tip
With Angled to Tip Length of
12 mm
Overall Length 11.5 cm (4 1/2")

Ophthalmology Instruments
Ophthalmologie Instrumente
 Oftalmologia Instrumentos
 Ophthalmologie Instruments
 Oftalmologia Strumenti

OP

OPHTHALMIC SURGERY INSTRUMENTS



OP-700-12
Anis Nucleus Manipulator
Straight Shaft & Curved Tip
With Ø 0.5 mm Ball at Tip
Overall Length 12 cm (4 ¾")



OP-701-12
Anis Nucleus Manipulator
Angled Shaft And Curved Tip
With Ø 0.5 mm Ball at Tip,
Angle to Tip Length of 10 mm
Overall Length 12 cm (4 ¾")



OP-703-12
Tennant Nucleus Rotator
Ø 0.6 mm Ball Shaped Tip
With Angled to Tip Length
of 10 mm
Overall Length 12 cm (4 ¾")



OP-705-11
Lippman Nucleus Spatula
Ø 0.5 mm Shaft With
Blunt Forked Tip Angle to Tip
Length of 10 mm
Overall Length 11.5 cm (4 ½")

Ophthalmology Instruments
 Ophthalmologie Instrumente
 Oftalmología Instrumentos
 Ophthalmologie Instrumente
 Oftalmologia Strumenti



OP-707-11
Girard Synechia Spatula
 Vaulted 0.5 mm Wide Blade
 With Semi Sharp Tip
 Angle to Tip Length of 10 mm
 Overall Length 11.5 cm (4 1/2")



OP-709-12
Obstbaum Synechia Spatula
 0.25 mm Wide Flat Spatula With
 Semi Sharp Tip Angled to Tip Length
 of 10 mm
 Overall Length 12 cm (4 3/4")



OP-711-13
Moran LASIK Enhancement Spatula
 Double Ended Fukasaku Spatula On
 One Side & Miniature Paton Spatula
 on Other Side
 Overall Length 13.5 cm (5 1/4")

Ophthalmology Instruments
Ophthalmologie Instrumente
 Oftalmologia Instrumentos
 Ophthalmologie Instruments
 Oftalmologia Strumenti

OP

OPHTHALMIC SURGERY INSTRUMENTS

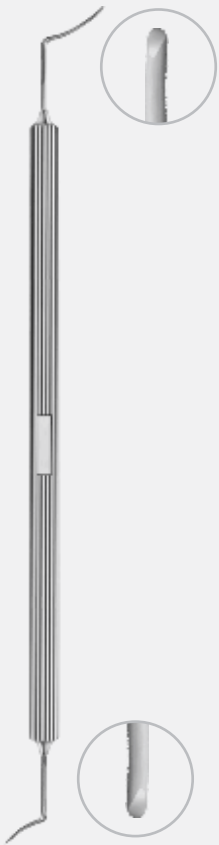

OP-713-14
Hersh IntraLase Flap Spatula
Double Ended 2 x 6 mm and
2 x 10 mm Spatula With
Beveled Blade Edges
Overall Length 14 cm (5 1/4")



OP-715-13
Binder Flap Separator & Elevator
1 mm Wide Spatula With 0.7 mm Long
Rounded Tip (0.1 mm x 0.3 mm), Angle
to Tip Length of 10 mm
Overall Length 13 cm (5")



OP-717-12
Fukasaku LASIK Spatula
1.2 mm Wide Gently Curved
Spatula With Round Anterior
Edge and Flat Posterior Edge,
Angled to Tip Length of 12 mm
Overall Length 12 cm (4 3/4")



Ophthalmology Instruments
Ophthalmologie Instrumente
Oftalmología Instrumentos
Ophthalmologie Instrumente
Oftalmologia Strumenti



OP-719-12

Guimaraes LASIK Spatula

1.2 mm Wide Gently Curved Bi-Convex Spatula With Semi-Sharp Edge
Overall Length 12 cm (4 3/4")

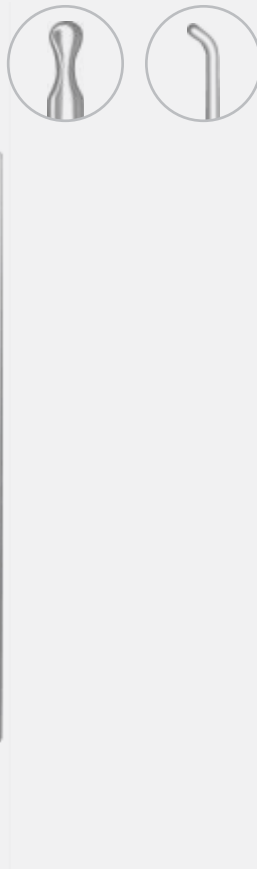

OP-720-13

Katzen LASIK Flap Spatula

Double Ended With 2 mm Wide Bi-Convex Notched Spatula on One Side And Ø 0.2 mm Modified Sinskey Hook on Other Side
Overall Length 13.5 cm (5 1/4")



OP-723-12

Maddox LASIK Spatula

Double Ended Spatula Combines a 2 mm Wide Flat And a Ø 0.25 mm Cylindrical Spatula With 7 mm from Angle to Tip Length On Both Sides
Overall Length 12.5 cm (5")

Ophthalmology Instruments
Ophthalmologie Instrumente
Ofthalmologia Instrumentos
Ophtalmologie Instruments
Ofthalmologia Strumenti

OP

OPHTHALMIC SURGERY INSTRUMENTS



OP-725-11

LASIK Flap Manipulator

Delicate Ø 0.3 mm Olive Tip Manipulator
With Angle to Tip Length of 10 mm
Overall Length 11.5 cm (4 ½")



OP-726-11

Hirschmann Lens Spatula

0.6 mm Wide Spatula With 0.2 mm
Notches on Both Sides
Overall Length 11.5 cm (4 ½")



OP-727-12

Jaffe Lens Spatula

0.5 mm Thick Smooth Flat Spatula With Angled
to Tip Length of 10 mm
Overall Length 12 cm (4 ¾")

Ophthalmology Instruments
Ophthalmologie Instrumente
Oftalmología Instrumentos
Ophthalmologie Instruments
Oftalmologia Strumenti

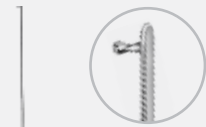

OP-728-12

Straight \varnothing 0.25 mm Hourglass Shaped Tip With 0.5 mm Height

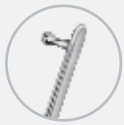

Lester IOL Manipulator
Overall Length 12 cm (4 3/4")



OP-731-11

Lester IOL Manipulator
 \varnothing 0.25 mm Hourglass Shaped Tip With 0.5 mm Height With Angled to Tip Length of 10 mm Vaulted Shanks
Overall Length 11.5 cm (4 1/2")

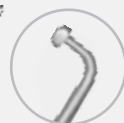

OP-733-12

Hunkeler IOL Manipulator
 \varnothing 0.3 mm Hemi-Ball Shaped Tip With Angle to Tip Length of 10 mm
Overall Length 12 cm (4 3/4")

Ophthalmology Instruments
Ophthalmologie Instrumente
Oftalmologia Instrumentos
Ophtalmologie Instruments
Oftalmologia Strumenti

OP

OPHTHALMIC SURGERY INSTRUMENTS



OP-735-12
Alio-Kelman IOL Hook
Ø 0.2 mm Tip With
0.5 mm Height With Angle
to Tip Length of 10 mm
Overall Length 12 cm (4 ¾")



OP-738-12
Aker Lens Pusher
0.8 mm Smooth, Fish
Mouth Shaped Jaws
Overall Length 12.5 cm (5")

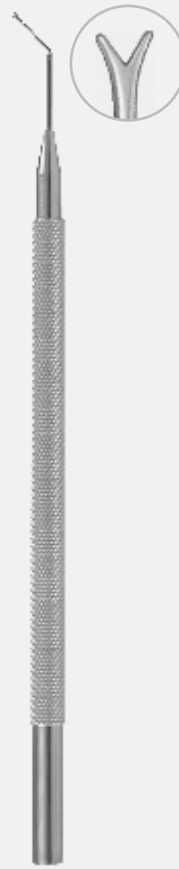

OP-739-11
Bechert Lens Pusher
0.78 mm Vertically Forked
Tip With Angled to Tip
Length of 10 mm
Overall Length 11.5 cm (4 ½")



OP-741-13
Elschnig Cyclodialysis Spatula
Blunt Tip 1 mm Wide Spatula
With Angle To Tip Length of 10 mm
Overall Length 11.5 cm (4 ½")

Ophthalmology Instruments
Ophthalmologie Instrumente
Oftalmología Instrumentos
Ophthalmologie Instruments
Oftalmologia Strumenti



OP-743-13
Castroviejo Synechia Spatula
Double Ended Spatula 0.5 mm Wide With 0.25 mm Thickness of Blades, 10 mm From Angle to Tip on One Side and 15 mm From Angle to Tip on Other Side, Semi Sharp Tips
Overall Length 13 cm (5")



Castroviejo Cyclodialysis Spatula
Overall Length 13 cm (5")

OP-745-25
Double Ended Spatula 0.25 mm Wide With 0.25 mm Thickness 10 mm From Angle to Tip on One Side and 15 mm From Angle to Tip on Other Side, Blunt Tip

OP-745-50
Double Ended Spatula 0.25 mm Wide With 0.5 mm Thickness 10 mm From Angle to Tip on One Side and 15 mm From Angle to Tip on Other Side, Blunt Tip



OP-749-12
Barrett Nucleus Expressor
Curved Shaft With Ø 2 mm Bulbous Tip
Overall Length 12 cm (4 ¾")

Ophthalmology Instruments
Ophthalmologie Instrumente
Ofthalmologia Instrumentos
Ophthalmologie Instruments
Ofthalmologia Strumenti

OP

OPHTHALMIC SURGERY INSTRUMENTS



Lewis Lens Loop
Overall Length 13 (5")

OP-750-01
Smooth 5 mm Wide Curved Loop Shaped Tip

OP-750-02
Smooth 6 mm Wide Curved Loop Shaped Tip



OP-752-13
New Orleans Lens Loop
Smooth 5 mm Wide Slightly Curved
Loop Shaped Tip
Overall Length 13.5 cm (5 1/4")

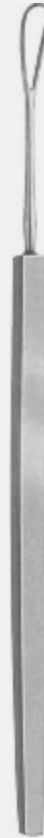

OP-754-13
Wilder Lens Loop
Serrated 4 mm Wide Curved Loop
Shaped Tip
Overall Length 13.5 cm (5 1/4")



Ophthalmology Instruments
Ophthalmologie Instrumente
Oftalmología Instrumentos
Ophthalmologie Instruments
Oftalmologia Strumenti



OP-757-15
Kirby Lens Loop and Muscle Hook
Double Ended With 5 mm Wide Loop Shaped Tip on One Side and 12 mm Muscle Hook on Other Side With 2.0 mm Bulbous Tip
Overall Length 15 cm (6")



OP-758-14
Morrison Lens Loop and Probe
Double Ended With 4.5 mm Wide Loop Shaped Tip on One Side and Ø 0.8 mm Olive Tip Probe on Other Side
Overall Length 14.5 cm (5 3/4")



OP-760-13
Kansas Lens Loop
Serrated 3.0 mm Wide Slightly Curved Loop Shaped Tip
Overall Length 13.5 cm (5 1/4")

Ophthalmology Instruments
Ophthalmologie Instrumente
Ofthalmologia Instrumentos
Ophtalmologie Instruments
Ofthalmologia Strumenti

OP

OPHTHALMIC SURGERY INSTRUMENTS



OP-761-13
Keener-Arlt Lens Loop
Serrated 3.0 mm Wide Curved
Loop Shaped Tip
Overall Length 13.5 cm (5 1/4")



OP-765-10
Alfonso Nucleus Trisector
Oval 2.5 mm Wide Semi Sharp Fenestrated
Blade To Be Used With OP-775-02
Overall Length 10.5 cm (4 1/4")



OP-767-10
Bucher-Kansas Nucleus Trisector
Triangular 2.5 mm Wide Semi Sharp
Fenestrated Blade To Be Used With OP-775-03
Overall Length 10.5 cm (4 1/4")

Ophthalmology Instruments
Ophthalmologie Instrumente
Oftalmología Instrumentos
Ophthalmologie Instrumente
Oftalmologia Strumenti



OP-769-11
Kansas Nucleus Trisector
Triangular 4 mm Wide Semi Sharp Fenestrated Blade To Be Used With OP-773-12
Overall Length 11 cm (4 1/4")



OP-771-11
Kansas Nucleus Bisector
10 mm Long Semi Sharp Blade Used With OP-773-12 For Small Manual Incision Surgery
Overall Length 11.5 cm (4 1/4")



OP-773-12
Kansas Nucleus Vectis
3.0 mm Wide Spatula Shaped Blade
Overall Length 12 cm (4 3/4")

Ophthalmology Instruments
Ophthalmologie Instrumente
Oftalmologia Instrumentos
Ophtalmologie Instruments
Oftalmologia Strumenti

OP

OPHTHALMIC SURGERY INSTRUMENTS



Alfonso Cutting Platform
Overall Length 12.5 cm (5")

OP-775-02
2.0 mm Wide Blade Used as Cutting
Block For Nucleus Bisector and Trisector

OP-775-03
3.0 mm Wide Blade Used as Cutting
Block For Nucleus Bisector and Trisector



OP-779-12
Giannetti Nucleus Capture Spoon
Inclined, Arcuate 2.6 mm Wide Spoon
Overall Length 12.5 cm (5")

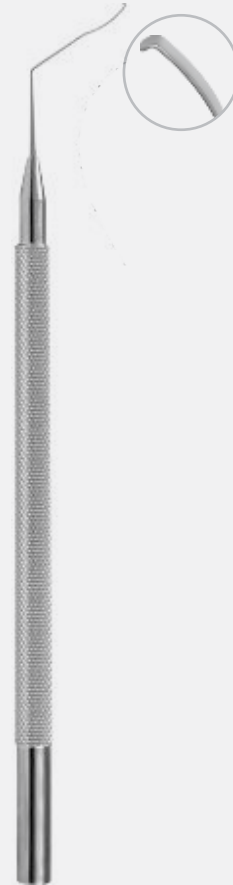

OP-781-12
Giannetti Nucleus Capture Spatula
2 mm Wide Blunt Tip Arcuate Nucleus
Capture Spatula
Overall Length 12.5 cm (5")



Ophthalmology Instruments
Ophthalmologie Instrumente
Oftalmología Instrumentos
Ophthalmologie Instruments
Oftalmologia Strumenti

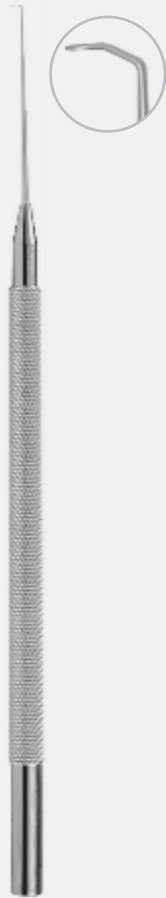

OP-783-12
Giannetti Nucleus Capture Hook
Straight Hook For Nucleus Manipulation
Overall Length 12.5 cm (5")



OP-790-13
Culler Lens Spoon
5 x 9 mm Spoon Shaped Tip
Overall Length 13 cm (5")



OP-793-14
Paton Spatula & Spoon
6 mm Wide and 15 mm Long Grooved Spoon Blade and
2 x 31 mm Spatula Shaped Blade With Last 7 mm Angled Tip
Overall Length 14 cm (5 1/2")

Ophthalmology Instruments
Ophthalmologie Instrumente
Ofthalmologia Instrumentos
Ophtalmologie Instruments
Ofthalmologia Strumenti

OP

OPHTHALMIC SURGERY INSTRUMENTS



OP-795-04

Rosenwasser Lamella Donor Shovel

9 mm Long and 4 mm Wide Plate With Retaining
Rim on Two Sides
Overall Length 11.5 cm (4 ½")



OP-795-05

Rosenwasser Lamella Donor Shovel

9 mm Long and 5 mm Wide Plate With Retaining
Rim on Three Sides
Overall Length 11.5 cm (4 ½")



Ophthalmology Instruments
Ophthalmologie Instrumente
Oftalmología Instrumentos
Ophthalmologie Instruments
Oftalmologia Strumenti



OP-796-00
Carter Sphere Introducer
With Spring Loaded Plunger To Hold and Introduce Eye Spheres
Overall Length 12.5 cm (5")



OP-798-00
Foster Enucleation Snare
With Ratcheting Wing-Nut Handle
Overall Length 14.5 cm (5.½")



OP-798-90
Twisted Wires For Foster Enucleation Snare
Pack of 12



OP-799-13
Eye Enucleation Forcep
Curved, S Shaped, Longitudinally Serrated
Overall Length 13.5 cm (5 ¼")

Ophthalmology Instruments
Ophthalmologie Instrumente
Ofthalmologia Instrumentos
Ophtalmologie Instruments
Ofthalmologia Strumenti

OP

OPHTHALMIC SURGERY INSTRUMENTS



OP-800-01
Bunge Evisceration Spoon
Flat and Smooth Ø 10.0 mm Spoon
Shaped Blade
Overall Length 14 cm (5 ½")



OP-800-02
Bunge Evisceration Spoon
Flat and Smooth Ø 12.0 mm
Spoon Shaped Blade
Overall Length 14 cm (5 ½")



OP-802-15
Wells Enucleation Spoon
21 mm Wide Spoon With
5 x 10 mm Notch
Overall Length 15 cm (6")



OP-803-00
Dastoor Erisophake (Bell)
Overall Length 6 cm (2 ¼")

Ophthalmology Instruments
Ophthalmologie Instrumente
Oftalmología Instrumentos
Ophthalmologie Instrumente
Oftalmologia Strumenti



OP-804-12
Graether Collar Button
Straight, Ø 0.6 mm Collar Button Shaped
Micro Iris Retractor
Overall Length 12.5 cm (5")



OP-805-12
Graether Collar Button
Angled, Ø 0.6 mm Collar Button Shaped
Micro Iris Retractor With Angle to Tip
Length of 10 mm
Overall Length 12.5 cm (5")



OP-811-11
Z Hook Manipulator
Ø 0.2 mm Z Shaped Hook With Angle to
Tip Length of 10 mm
Overall Length 11.5 cm (4 ½")

Ophthalmology Instruments
Ophthalmologie Instrumente
Oftalmologia Instrumentos
Ophtalmologie Instruments
Oftalmologia Strumenti

OP

OPHTHALMIC SURGERY INSTRUMENTS



OP-813-11
Sinskey (Reversed) Lens Manipulating Hook
Ø 0.2 mm Blunt Tip With 0.35 mm Height
With Angle to Tip Length of 10 mm
Overall Length 11.5 cm (4 ½")



OP-815-12
Bonn Micro Iris Hook
Curved Hook With Ø 0.15 mm Blunt Tip
Overall Length 12.5 cm (5")



OP-817-12
Shepard Iris Hook
1.0 mm Wide Ø 0.2 mm Blunt Tip
Overall Length 12.5 cm (5")

Ophthalmology Instruments
Ophthalmologie Instrumente
Oftalmología Instrumentos
Ophthalmologie Instrumente
Oftalmologia Strumenti



OP-819-01
Jaffe Lens Manipulating Hook
Ø 0.15 mm Hook and 0.35 mm Height,
Flat Handle
Overall Length 11.5 cm (4 ½")



OP-819-02
Clayman-Jaffe Lens Manipulating Hook
Ø 0.15 mm Hook and 0.35 mm Height With
Angle to Tip Length of 10 mm Flat Handle
Overall Length 11.5 cm (4 ½")



OP-821-01
Sinskey Lens Manipulating Hook
Ø 0.25 mm Blunt Tip With 0.35 mm
Height, Flat Handle
Overall Length 11.5 cm (4 ½")



OP-821-02
Harris-Sinskey Lens Manipulating Hook
Ø 0.25 mm Blunt Tip With 0.35 mm Height With
Angle to Tip Length of 10 mm Flat Handle
Overall Length 11.5 cm (4 ½")



OP-823-12
Lewicky Lens Manipulating Hook
Vaulted Shaft, Ø 0.2 mm Blunt Tip With Angle
to Tip Length of 11 mm
Overall Length 12 cm (4 ¾")

Ophthalmology Instruments
Ophthalmologie Instrumente
Oftalmologia Instrumentos
Ophtalmologie Instruments
Oftalmologia Strumenti

OP

OPHTHALMIC SURGERY INSTRUMENTS

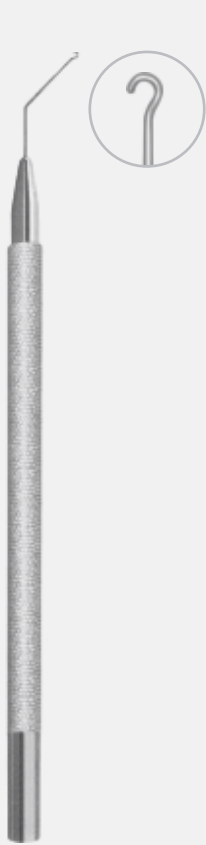

OP-825-11

Hirschmann Iris Hook
Ø 0.2 mm Blunt Round Tip
Angled to Tip Length of 10 mm
Overall Length 11 cm (4 ¼")



OP-826-01

Sinskey Lens Manipulating Hook
Ø 0.25 mm Blunt Tip With 0.35 mm
Height
Overall Length 11 cm (4 ½")



OP-826-02

Sinskey Lens Manipulating Hook
Ø 0.25 mm Blunt Tip With 0.35 mm
Height With Angle to Tip Length of
10 mm
Overall Length 11 cm (4 ½")

Ophthalmology Instruments
Ophthalmologie Instrumente
Oftalmología Instrumentos
Ophthalmologie Instrumente
Oftalmologia Strumenti



OP-826-03
Sinskey II Lens Manipulating Hook
Ø 0.2 mm Blunt Tip With 0.35 mm
Height
Overall Length 11.5 cm (4 ½")



OP-826-04
Sinskey II Lens Manipulating Hook
Ø 0.2 mm Blunt Tip With 0.35 mm
Height With Angle to Tip Length of
10 mm
Overall Length 11.5 cm (4 ½")



OP-827-01
Straight
0.76 mm x 0.75 mm
x 0.25 mm Rotator Tip



OP-827-02
Angled
0.76 mm x 0.75 mm
x 0.25 mm Rotator Tip

Kuglen Iris Hook and Lens Manipulator
Overall Length 11.5 cm (4 ½")

Ophthalmology Instruments
Ophthalmologie Instrumente
Oftalmologia Instrumentos
Ophtalmologie Instruments
Oftalmologia Strumenti

OP

OPHTHALMIC SURGERY INSTRUMENTS



OP-829-01
Kuglen Iris Hook and Lens Manipulator
0.76 mm x 0.75 mm x 0.25 mm Clover
Leaf Model Tip
Overall Length 11.5 cm (4 1/2")

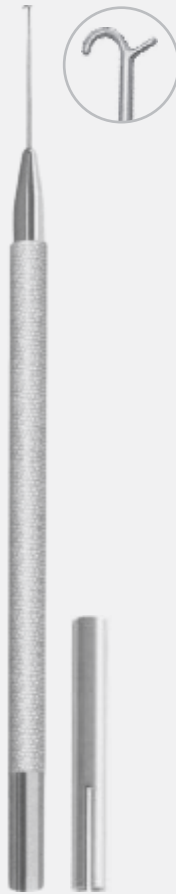

OP-831-12
Rentsch Boat Hook
Ø 0.2 mm Double Hooks
Overall Length 12 cm (4 3/4")

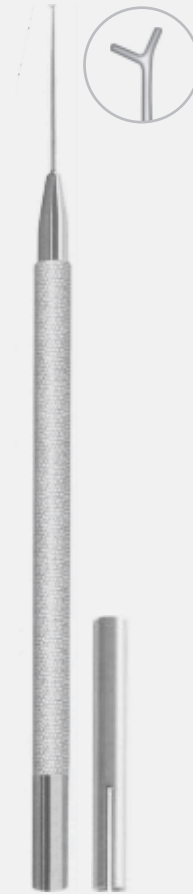

OP-833-12
Osher Y Hook
0.67 mm Wide Vertical Fork Shaped
Tips With Angled to Tip Length of 9 mm
Overall Length 12 cm (4 3/4")

Ophthalmology Instruments
Ophthalmologie Instrumente
Oftalmología Instrumentos
Ophthalmologie Instrumente
Oftalmologia Strumenti



OP-835-01
Fenzl Lens Manipulating Hook
Ø 0.15 mm Hook and
0.5 mm Height
Overall Length 12 cm (4 ¾")



OP-835-02
Fenzl Lens Manipulating Hook
Ø 0.15 mm Hook and
0.5 mm Height With Angle to
Tip Length of 9 mm
Overall Length 12 cm (4 ¾")



OP-837-01
Straight
Ø 0.15 mm Dual Fork
Shaped Tip

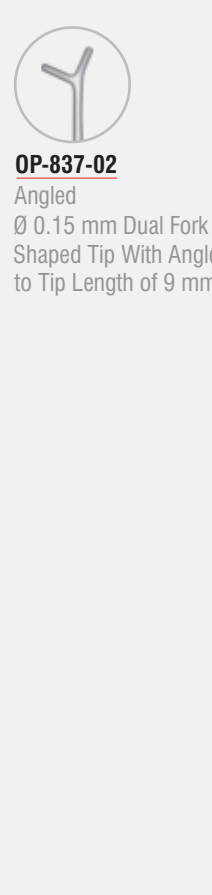

OP-837-02
Angled
Ø 0.15 mm Dual Fork
Shaped Tip With Angle
to Tip Length of 9 mm

Maltzman-Fenzl Lens Manipulating Hook
Overall Length 12 cm (4 ¾")

Ophthalmology Instruments
Ophthalmologie Instrumente
Oftalmologia Instrumentos
Ophtalmologie Instruments
Oftalmologia Strumenti

OP

OPHTHALMIC SURGERY INSTRUMENTS



OP-839-02
Jaffe-Maltzman Lens Manipulating Hook
Angled, Ø 0.15 mm Dual Fork
Shaped Tip With Angle to Tip Length of
11 mm
Overall Length 12 cm (4 ¾")



OP-841-01
Giannetti Push Pull Manipulator
Straight
0.76 mm x 0.75 mm x 0.25 mm Tip
Overall Length 12.5 cm (5")



OP-843-02
Deitz ICL Manipulator
0.8 mm Wide Vertical Fork
Shaped Tips, 11 mm Long
From Bend to Tip
Overall Length 12 cm (4 ¾")

*ICL® is a registered trademark of
STAAR Surgical Company*

Ophthalmology Instruments
Ophthalmologie Instrumente
Oftalmología Instrumentos
Ophthalmologie Instruments
Oftalmologia Strumenti



OP-845-01
Fixation Hook
Curved 2 Sharp
Pronged Hook With
1.5 mm Spread
Overall Length 12.5 cm (5")



OP-845-02
Fixation Hook
Curved 2 Sharp
Pronged Hook With
2.0 mm Spread
Overall Length 12.5 cm (5")



Twist Hook
0.3 mm Hook
Overall Length 11 cm (4 1/4")



OP-849-01
Right
(Clockwise)



OP-849-02
Left
(Counter-Clockwise)



OP-851-09
Silverman Fixation Hook
Blunt Cone Shaped Tips With
3.0 mm Spread
Overall Length 9.5 cm (3 3/4")

Ophthalmology Instruments
Ophthalmologie Instrumente
Oftalmologia Instrumentos
Ophtalmologie Instruments
Oftalmologia Strumenti

OP

OPHTHALMIC SURGERY INSTRUMENTS



OP-861-11
Lu-Mendez Fixation Ring and Guide
I.D. Ø 11 mm, LRI Guide Marked in 10°
Increments and Fixation Ring With 15
Blunt Teeth
Overall Length 11 cm (4 ¼")

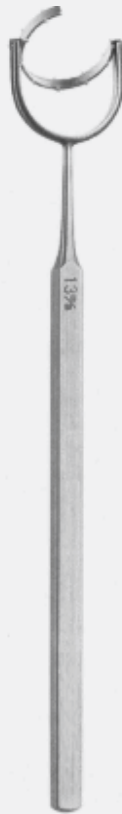

OP-863-11
Gimbel Stabilization Ring
Offset C Shaped Swivel Fixation
Ring With Ø 13 mm With
10 mm Opening and 9 Blunt Teeth
Overall Length 11.5 cm (4 ½")



OP-865-13
C Shaped Swivel Fixation Ring
With Ø 13 mm With
10 mm Opening and 9 Blunt Teeth

OP-865-16
C Shaped Swivel Fixation Ring
With Ø 16 mm With
10 mm Opening and 12 Blunt Teeth

Fine-Thornton Swivel Fixation Ring
Overall Length 12 cm (4 ¾")



Ophthalmology Instruments
Ophthalmologie Instrumente
Oftalmología Instrumentos
Ophthalmologie Instrumente
Oftalmologia Strumenti



OP-867-10
Thornton Globe Fixation Ring
Ø 16 mm Globe Fixation Ring
With 12 Blunt Teeth
Overall Length 10 cm (4")



OP-869-11
Hofmann-Thornton Globe Fixation Ring
Ø 16 mm Globe Fixation Ring With
Swivel Handle And 12 Blunt Teeth
Overall Length 11 cm (4 1/4")



OP-871-12
Stevens Tenotomy Hook
Curved 6 mm Wide Hook
Overall Length 12.5 cm (5")

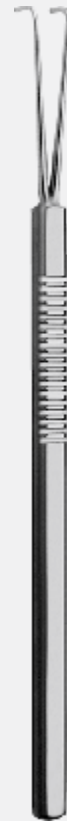

OP-872-12
Manson Double Strabismus Hook
Angled 3.0 mm Wide Fork Shaped
Tips With 7.0 mm Spread
Overall Length 12.5 cm (5")

Ophthalmology Instruments
Ophthalmologie Instrumente
Ofthalmologia Instrumentos
Ophtalmologie Instruments
Ofthalmologia Strumenti

OP

OPHTHALMIC SURGERY INSTRUMENTS



OP-873-12
Helveston Teaser Hook
Angled 6 mm Wide Blunt Tip Hook
Overall Length 12.5 cm (5")



OP-875-13
Gass Retinal Detachment Hook
Flattened 13 mm Wide Graefe
Type Hook With 1.5 mm Oval Eye
13 cm (5")



Helveston Finder Hook
Overall Length 12.5 cm (5")

OP-877-01
Small 8 mm Wide Hook
With Extra Delicate Cone
Shaped Tip

OP-877-02
Large 12 mm Wide Hook With
Extra Delicate Cone Shaped Tip

Ophthalmology Instruments
Ophthalmologie Instrumente
Oftalmología Instrumentos
Ophthalmologie Instrumente
Oftalmologia Strumenti



Helveston Muscle Hook
Blunt Spatula Shaped Tip
Overall Length 13 cm (5")

OP-879-01
8 mm Wide

OP-879-02
10 mm Wide

OP-879-03
12 mm Wide



OP-881-01
Jameson Muscle Hook
Small, 6 mm Wide Hook
With 2 mm Bulbous Tip
Overall Length 13 cm (5")



OP-881-02
Jameson Muscle Hook
Large, 8 mm Wide Hook
With 2 mm Bulbous Tip
Overall Length 13.5 cm (5 1/4")

Ophthalmology Instruments
Ophthalmologie Instrumente
Oftalmologia Instrumentos
Ophtalmologie Instruments
Oftalmologia Strumenti

OP

OPHTHALMIC SURGERY INSTRUMENTS



OP-883-13
Green Strabismus Hook
Flat 8 mm Wide Hook
Overall Length 13.5 cm (5 ¼")



OP-885-13
Chavasse Strabismus Hook
12 mm Wide W Shaped Hook
Overall Length 13 cm (5")



OP-887-11
Chayet Corneal Marker
For LASIK Surgery
Overall Length 11.5 cm (4 ½")



OP-891-11
Kellen Capsulorrhexis Marker
Ø 6 mm Marking Ring
With 2.5 mm Extensions
Overall Length 11.5 cm (4 ½")

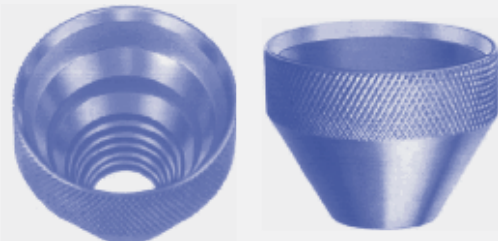

OP-900-00
Maloney Intra-Operative Keratometer
For Qualitative Measurement of Astigmatism
Cone Shaped With Maximum Ø 31.0 mm
and 21.5 cm Height, Titanium
Overall Length 11.5 cm (4 ½")



Ophthalmology Instruments
Ophthalmologie Instrumente
Oftalmología Instrumentos
Ophthalmologie Instruments
Oftalmologia Strumenti



OP-901-11
Mendez Degree Gauge
Ø 12.0 mm I.D. and 18.0 mm O.D.
Measures 0-180° With 10° Increments
Overall Length 11.5 cm (4 ½")



OP-905-11
Greene Visual Axis Marker
Ø 0.5 mm With Concave Tip
Overall Length 11.5 cm (4 ½")



OP-907-11
McDonald Optic Zone Marker
Double Ended, With Cross Hairs
Ø 6.5 mm and 7.0 mm
Overall Length 11 cm (4 ½")

Ophthalmology Instruments
 Ophthalmologie Instrumente
 Oftalmologia Instrumentos
 Ophthalmologie Instruments
 Oftalmologia Strumenti

OP

OPHTHALMIC SURGERY INSTRUMENTS



<u>OP-911-01</u> Ø 3.0 mm	<u>OP-911-02</u> Ø 3.25 mm	<u>OP-911-03</u> Ø 3.5 mm	<u>OP-911-04</u> Ø 3.75 mm	<u>OP-911-05</u> Ø 4.0 mm	<u>OP-911-06</u> Ø 4.25 mm	<u>OP-911-07</u> Ø 4.5 mm	<u>OP-911-08</u> Ø 4.75 mm
<u>OP-911-09</u> Ø 5.0 mm	<u>OP-911-10</u> Ø 6.0 mm	<u>OP-911-11</u> Ø 7.0 mm	<u>OP-911-12</u> Ø 8.0 mm	<u>OP-911-13</u> Ø 9.0 mm			

Bores Optic Zone Marker
 Without Cross Hairs
 Overall Length 10.5 cm (4 1/4")



<u>OP-913-01</u> Ø 3.0 mm	<u>OP-913-02</u> Ø 3.25 mm	<u>OP-913-03</u> Ø 3.5 mm	<u>OP-913-04</u> Ø 3.75 mm	<u>OP-913-05</u> Ø 4.0 mm	<u>OP-913-06</u> Ø 4.25 mm	<u>OP-913-07</u> Ø 4.5 mm	<u>OP-913-08</u> Ø 4.75 mm
<u>OP-913-09</u> Ø 5.0 mm	<u>OP-913-10</u> Ø 5.5 mm	<u>OP-913-11</u> Ø 6.0 mm	<u>OP-913-12</u> Ø 7.0 mm	<u>OP-913-13</u> Ø 8.0 mm	<u>OP-914-14</u> Ø 9.0 mm		

Hoffer Optic Zone Marker
 With Cross Hairs
 Overall Length 10.5 cm (4 1/4")

Ophthalmology Instruments
Ophthalmologie Instrumente
Oftalmología Instrumentos
Ophthalmologie Instruments
Oftalmologia Strumenti



OP-915-08

With 8 Radial Blades

OP-915-12

With 12 Radial Blades

OP-915-16

With 16 Radial Blades

Anis Radial Marker

Overall Length 10 cm (4")



OP-917-10

Anis Corneal Suture Placement Marker
Ø 8 mm Center Opening and 8 Radial Blades
Overall Length 10 cm (4")



OP-919-09

Fechtner Trabeculectomy Marker
With U-Shaped 2.75mm Marking
Pattern and Side Landmarks
Overall Length 9 cm (3 1/2")



OP-930-12

Helveston Scleral Ruler
Vaulted 15 mm Long Blade
With Notches in 5 mm Increments
Overall Length 12 cm (4 3/4")

Ophthalmology Instruments
Ophthalmologie Instrumente
Ofthalmologia Instrumentos
Ophtalmologie Instruments
Ofthalmologia Strumenti

OP

OPHTHALMIC SURGERY INSTRUMENTS

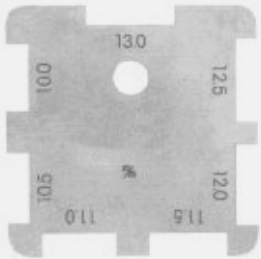

OP-932-01
Stahl Corneal Caliper
Measures 10.0 mm to 13.0 mm
With 0.5 mm Increments

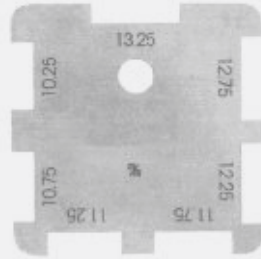

OP-932-02
Stahl Corneal Caliper
Measures 10.25 mm to 13.25 mm
With 0.5 mm Increments



OP-934-30
Braunstein Caliper
Double Ended Fixed Caliper
For 3.0 and 3.5 mm Marking



OP-934-35
Braunstein Caliper
Double Ended Fixed Caliper
For 3.5 and 4.0 mm Marking



OP-935-01
Schioetz Tonometer
Inclined Scale
With 5.5, 7.5 & 10 Grams Weights

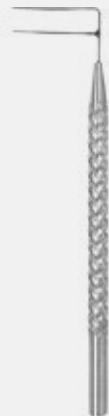

OP-941-01
Harms Trabeculotomy Probe
Right, Two 10 mm Long Tips
With 3 mm Spread
Overall Length 5 cm (2")



OP-941-02
Harms Trabeculotomy Probe
Left, Two 10 mm Long Tips
With 3 mm Spread
Overall Length 5 cm (2")

Ophthalmology Instruments
Ophthalmologie Instrumente
Oftalmología Instrumentos
Ophthalmologie Instruments
Oftalmologia Strumenti



OP-944-08
Infant Lacrimal Dilator
Ø 0.4 mm Very Fine 21 mm Long Blunt Tip
Overall Length 8 cm (3")



OP-946-10
Muldoon Lacrimal Dilator
Ø 0.35 mm Cylindrical Tip, With 27 mm Long Taper
Overall Length 10 cm (4")



OP-948-01
Wilder Lacrimal Dilator
Fig. 1, Fine, Tapered
Ø 0.32 mm / 32 mm Long Point
Overall Length 10.5 cm (4 1/4")



OP-948-02
Wilder Lacrimal Dilator
Fig. 2, Medium, Tapered
Ø 0.75 mm / 23 mm Long Point
Overall Length 10.5 cm (4 1/4")



OP-948-03
Wilder Lacrimal Dilator
Fig. 3, Long, Tapered
Ø 1.1 mm / 19 mm Long Point
Overall Length 10.5 cm (4 1/4")

Ophthalmology Instruments
Ophthalmologie Instrumente
Oftalmologia Instrumentos
Ophthalmologie Instruments
Oftalmologia Strumenti



OP-950-14

Castroviejo Lacrimal Dilator

Double Ended, One Fine Tapered (Ø 0.32 mm / 32 mm Long) and One Medium Tapered (Ø 0.75 / 23 mm Long) Points



OP-953-14

Worst Pigtail Probe

Double Ended, 8.0 mm Curved Blunt Probe With Eye Holes
Overall Length 16 cm (6 ¼")



OP-956-14

Crawford Retrieval Hook

Designed to Pick The Crawford Probe
Overall Length 14.5 cm (5 ¾")



OP-960-00

Crawford Lacrimal Intubation Set

Including Silicone Tube and Two Olive Tip Probes Ø 0.6 mm
Probes Length 11 cm (4¼") Tube Length 30.5 cm (12")

Scalpel Handles, Scalpel Blades
Skalpgriffe, Skalpellklingen
Mangos de bisturís, Hojas de bisturís
Manches pour bistouris, Lames pour bistouris
Manici per bisturi, Lame per bisturi



SL-010-03
Bard-Parker Scalpel Handle # 3
Solid
Overall Length 12 cm (4 3/4")



SL-012-03
Bard-Parker Scalpel Handle # 3
Solid, CM Graduation
Overall Length 12 cm (4 3/4")



SL-100-11
Scalpel Blade # 11
Pack of 100
Fig. 11



SL-100-15
Scalpel Blade # 15
Pack of 100
Fig. 15



SL-206-10
10 cm (4")
SL-206-13
13 cm (5")
SL-206-15
15 cm (6")

Scalpel Handle
For Micro Scalpel Blades



SL-210-61
Scalpel Handle # 3
Fig. 61
Pack of 25



SL-210-62
Fig. 62



SL-210-63
Fig. 63



SL-210-64
Fig. 64



SL-210-65
Fig. 65



SL-210-66
Fig. 66



SL-210-67
Fig. 67



SL-210-68
Fig. 68



SL-210-69
Fig. 69

Blade Holders / Blade Breakers
Klingenhalter / Kingenbrecher
Porta-hojas / Rompe-hojas de afeitár
Pincettes pour saisir et casser les lames de rasoir
Pinze per afferrare e rompere le lamette de rasoio

OP

OPHTHALMIC SURGERY INSTRUMENTS

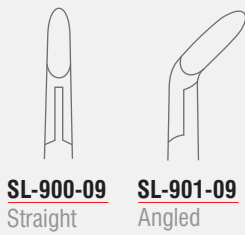

SL-900-09
Straight

SL-901-09
Angled

Troutman-Chris Blade Holder/Breaker
Round Handle
Overall Length 9 cm (3 1/2")



SL-910-11
Barraquer Blade Holder/Breaker
Overall Length 11 cm (4 1/4")



SL-916-13
Castroviejo Blade Holder/Breaker
Round Handle
Overall Length 13 cm (5")



Dissecting Scissors, Gum Scissors, Iris Scissors
 Präparierscheren, Zahnfleischscheren, Irisscheren
 Tijeras de disección, Tijeras para encías, Tijeras para iridectomía
 Ciseaux à dissection, Ciseaux à gencives, Ciseaux à iridectomie
 Forbici per dissezione, Forbici per gengi, Forbici per iridectomia



Ragnell (Kilner) Dissecting Scissor

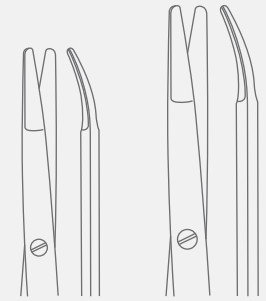

SS-243-12
12 cm (4 3/4")

SS-243-15
15 cm (6")



Goldman-Fox Gum Scissor
Overall Length 13 cm (5")



SS-400-13
Straight

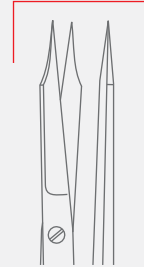

SS-400-13 SC
Straight



SS-401-13
Curved



SS-401-13 SC
Curved



Iris Scissor

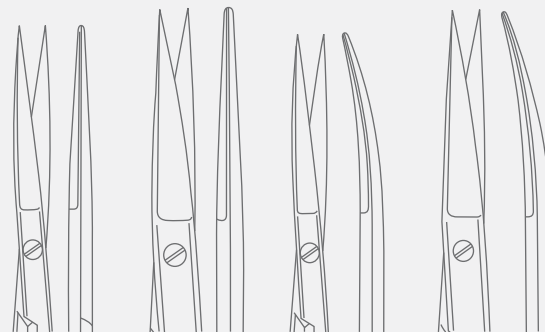

SS-430-09
Straight
9 cm (3 1/2")

SS-430-10
Straight
10 cm (4")

SS-431-09
Curved
9 cm (3 1/2")

SS-431-10
Curved
10 cm (4")

SUPEREdge™

Iris Scissors
Irisscheren
Tijeras para iridectomía
Ciseaux à iridectomie
Forbici per iridectomia

OP

OPHTHALMIC SURGERY INSTRUMENTS

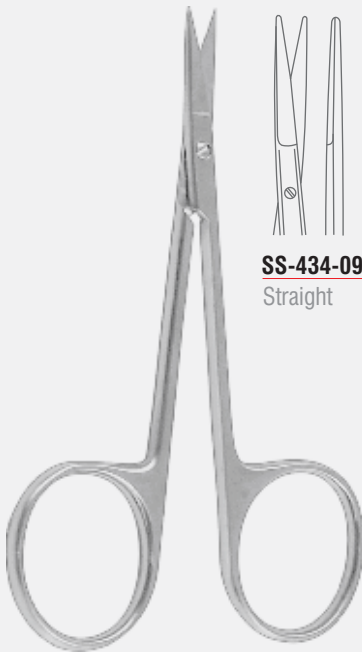

Bonn Iris Scissor
Overall Length 9 cm (3 1/2")

SUPER*Edge*[™]



Iris Scissor
Overall Length 11.5 cm (4 1/2")



Iris Scissors
Irisscheren
Tijeras para iridectomía
Ciseaux à iridectomie
Forbici per iridectomia



SS-446-12
Straight



SS-447-12
Curved

Iris Scissor
Overall Length 12.5 cm (5")

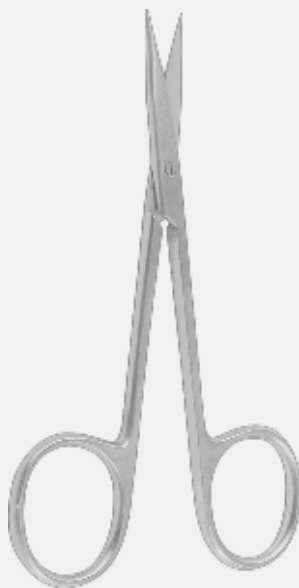

SS-450-10
Straight
Sharp/Sharp
10 cm (4")



SS-450-11
Straight
Sharp/Sharp
11 cm (4 1/2")



SS-451-10
Curved
Sharp/Sharp
10 cm (4")



SS-451-11
Curved
Sharp/Sharp
11 cm (4 1/2")



SS-450-11 SC
Straight
Sharp/Sharp
11 cm (4 1/2")



SS-451-11 SC
Curved
Sharp/Sharp
11 cm (4 1/2")

Stevens Tenotomy Scissor

SUPERedge™

Dissecting Scissors
Präparierscheren
Tijeras de disección
Ciseaux à dissection
Forbici per dissezione

OP

OPHTHALMIC SURGERY INSTRUMENTS

SUPER*Edge*[™]

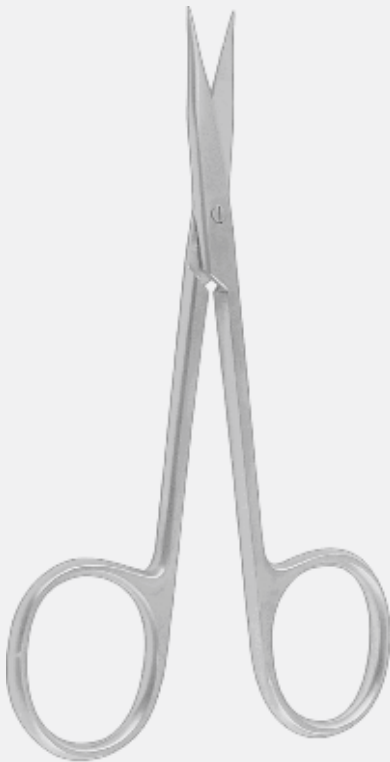

Stevens Tenotomy Scissor



SS-452-10
Straight
Blunt/Blunt
10 cm (4")



SS-452-11
Straight
Blunt/Blunt
11 cm (4 ½")



SS-452-12
Straight
Blunt/Blunt
12.5 cm (5")

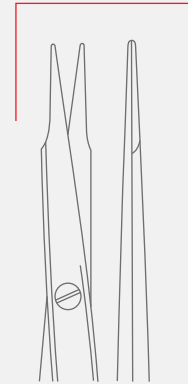

SS-452-11 SC
Straight
Blunt/Blunt
11 cm (4 ½")



SS-453-10
Curved
Blunt/Blunt
10 cm (4")



SS-453-11
Curved
Blunt/Blunt
11 cm (4 ½")



SS-453-11
Curved
Blunt/Blunt
12.5 cm (5")



Strabismus Scissors
Strabismusscheren
Tijeras para estrabismo
Ciseaux à strabisme
Forbici per strabismo



Strabismus Scissor
Overall Length 11.5 cm (4 1/2")

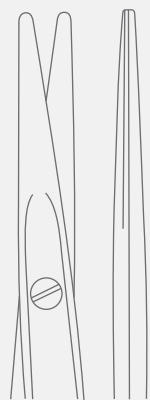

SS-456-11
Straight



SS-457-11
Curved

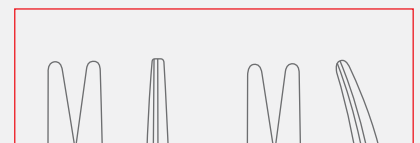

SS-456-11 SC
Straight



SS-457-11 SC
Curved

Dissecting Scissors
Präparierscheren
Tijeras de disección
Ciseaux à dissection
Forbici per dissezione

OP

OPHTHALMIC SURGERY INSTRUMENTS



SS-461-11

Littler Dissecting Scissor
Curved, Tip With Eye For Suture
Overall Length 11.5 cm (4 ½")



SS-466-11
Straight

Kilner Delicate Dissecting Scissor
Overall Length 11.5 cm (4 ½")



Enucleation Scissors
Enukleationsschere
Tijeras de enucleación
Ciseaux d'enucléation
Forbici per enucleazione



SS-469-11
Curved

Enucleation Scissor
Overall Length 11.5 cm (4 1/2")

Ribbon Ophthalmic Scissors
Band-Augenschere
Tijera oftálmica de cinta
Ciseaux ophtalmiques à ruban
Forbici oftalmica a nastro

OP

OPHTHALMIC SURGERY INSTRUMENTS

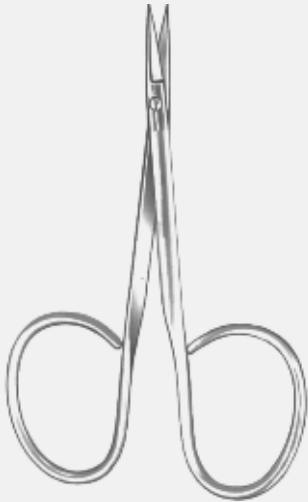

SS-484-09
Salyer Ribbon Scissor
Straight, Flat Shanks
Overall Length 9.5 cm (3 3/4")



Iris Scissor (Ribbon Type)
Overall Length 9.5 cm (3 3/4")

SS-486-09
Straight, Sharp, Flat Shanks

SS-487-09
Curved, Sharp, Flat Shanks



Iris Scissor (Ribbon Type)
Overall Length 10 cm (4")

SS-488-10
Straight, Blunt, Flat Shanks

SS-489-10
Curved, Blunt, Flat Shanks



Strabismus Scissor (Ribbon Type)
Overall Length 10 cm (4")

SS-492-10
Straight, Flat Shanks

SS-493-10
Curved, Flat Shanks



Ribbon Ophthalmic Scissors
Band-Augenschere
Tijera oftálmica de cinta
Ciseaux ophtalmiques à ruban
Forbici oftalmica a nastro



Stevens Tenotomy Scissor (Ribbon Type)
Overall Length 10 cm (4")

SS-496-10
Straight, Flat Shanks, Sharp Tips

SS-497-10
Curved, Flat Shanks, Sharp Tips

SS-498-10
Straight, Flat Shanks, Blunt Tips

SS-499-10
Curved, Flat Shanks, Blunt Tips

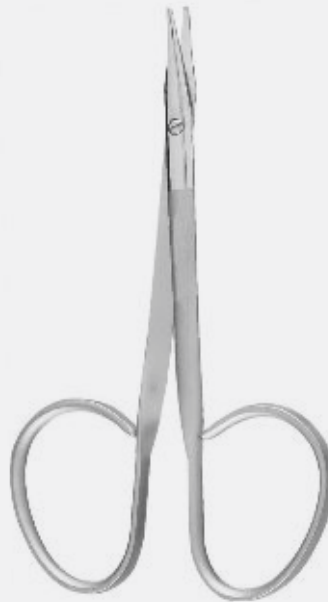

Gradle Scissor (Ribbon Type)
Overall Length 10 cm (4")

SS-500-10
Straight, Flat Shanks

SS-501-10
Curved, Flat Shanks



SS-507-11
Kaye Facelift Scissor (Ribbon Type)

Curved, Flat Shanks, Toothed
Overall Length 11 cm (4 1/2")

Micro Scissors
Mikroscheren
Micro-Tijeras
Micro-Ciseaux
Micro-Forbici

OP

OPHTHALMIC SURGERY INSTRUMENTS



SS-626-01
Williamson-Noble Micro Scissor
Straight, Sharp/Sharp 27 mm Long Blades With
Max. 14 mm Cutting Edge
Overall Length 11.5 cm (4 3/4")



Noyes Iris Scissor
Sharp/Sharp, 23 mm Long Blades With
Max. 14 mm Cutting Edge
Overall Length 12.5 cm (5")



SS-630-12
Straight

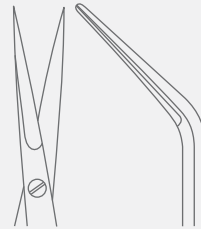

SS-631-12
Curved



Micro Scissors
Mikroscheren
Micro-Tijeras
Micro-Ciseaux
Micro-Forbici



SS-632-12
Straight

Noyes Iris Scissor
Sharp/Blunt
23 mm Long Blades With
Max. 14 mm Cutting Edge
Overall Length 12.5 cm (5")

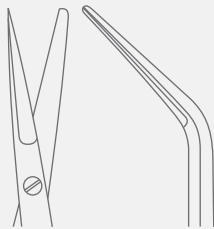

SS-633-12
Curved



SS-634-12
Straight

Noyes Iris Scissor
Blunt/Blunt
23 mm Long Blades With
Max. 14 mm Cutting Edge
Overall Length 12.5 cm (5")

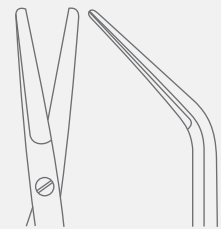

SS-635-12
Curved

Micro Scissors
Mikroscheren
Micro-Tijeras
Micro-Ciseaux
Micro-Forbici

OP

OPHTHALMIC SURGERY INSTRUMENTS

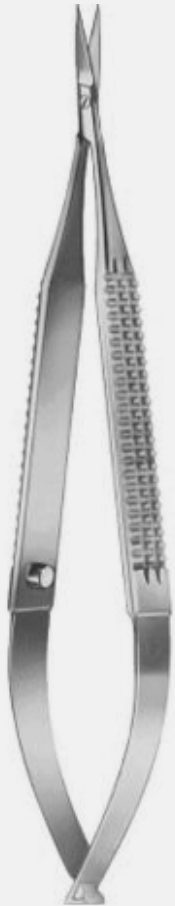

SS-636-12
Straight



SS-637-12
Curved

Micro Scissor
13 mm Long Blades
Max. With 10 mm Cutting Edge
Overall Length 12 cm (4 ³/₄")



Micro Scissors
Mikroscheren
Micro-Tijeras
Micro-Ciseaux
Micro-Forbici



Wecker Iris Scissor

8 mm Long Blades With Max. 5 mm Cutting Edge
Overall Length 11 cm (4 1/2")

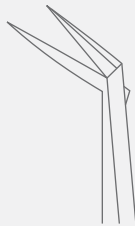

SS-641-11

Angled, Sharp/Sharp

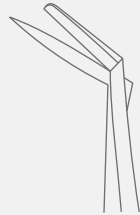

SS-643-11

Angled, Sharp/Blunt



SS-645-11

Angled, Blunt/Blunt



Barraquer Iris Scissor

9 mm Long Blades Max. 6 mm Cutting Edge
Overall Length 5.5 cm (2 1/4")

SS-647-05

Angled, 5 mm

SS-647-07

Angled, 7 mm

SS-647-10

Angled, 10 mm

Micro Scissors
Mikroscheren
Micro-Tijeras
Micro-Ciseaux
Micro-Forbici

OP

OPHTHALMIC SURGERY INSTRUMENTS



SS-649-01
Curved Right



SS-649-02
Curved Left

Holland DALK Scissor
Blunt Tips With Spatulated Inner Blade
8 mm Long Blades With
Max. 4 mm Cutting Edge
Overall Length 10.5 cm (4")



Castroviejo Corneoscleral Scissor
8 mm Long Blades With
Max. 4 mm Cutting Edge
Overall Length 10.5 cm (4")

SS-651-01
Curved Right

SS-651-02
Curved Left



Castroviejo Corneoscleral Scissor
12 mm Long Blades With
Max. 7 mm Cutting Edge
Overall Length 11 cm (4")

SS-653-01
Curved Right

SS-653-02
Curved Left



Micro Scissors
Mikroscheren
Micro-Tijeras
Micro-Ciseaux
Micro-Forbici



Troutman-Castroviejo Corneoscleral Scissor
With Lock
8 mm Long Blades With
Max. 4 mm Cutting Edge
Overall Length 10.5 cm (4")

SS-655-01
Curved Right
SS-655-02
Curved Left



Troutman-Castroviejo Corneoscleral Scissor
With Lock
12 mm Long Blades With
Max. 7 mm Cutting Edge
Overall Length 11 cm (4 1/2")

SS-657-01
Curved Right
SS-657-02
Curved Left

Micro Scissors
Mikroscheren
Micro-Tijeras
Micro-Ciseaux
Micro-Forbici

OP

OPHTHALMIC SURGERY INSTRUMENTS



Troutman-Katzin Corneal Transplant Scissor

Strongly Curved, With Lock
8 mm Long Blades With
Max. 4 mm Cutting Edge
Overall Length 10.5 cm (4")

SS-659-01

Curved Right

SS-659-02

Curved Left



Katzin Corneal Transplant Scissor

Strongly Curved
13 mm Long Blades With
Max. 7 mm Cutting Edge
Overall Length 11 cm (4 ½")

SS-661-01

Curved Right

SS-661-02

Curved Left



Micro Scissors
Mikroscheren
Micro-Tijeras
Micro-Ciseaux
Micro-Forbici



Castroviejo Universal Corneal Scissor
Curved, Blunt Tips
Overall Length 11 cm (4 1/2")

SS-663-11
10 mm Long Blades With
Max. 5 mm Cutting Edge

SS-665-11
12 mm Long Blades With
Max. 6 mm Cutting Edge

SS-667-11
14 mm Long Blades With
Max. 8 mm Cutting Edge



SS-669-11
Castroviejo Universal Corneal Scissor
Strongly Curved, Blunt Tips 15 mm Long Blades With
Max. 9 mm Cutting Edge
Overall Length 11.5 cm (4 1/2")

Micro Scissors
Mikroscheren
Micro-Tijeras
Micro-Ciseaux
Micro-Forbici

OP

OPHTHALMIC SURGERY INSTRUMENTS



SS-671-11
Castroviejo Keratoplasty Scissor
Angled to Side, Blunt Tips
14 mm Long Blades With
Max. 9 mm Cutting Edge
Overall Length 11.5 cm (4 ½")



SS-673-11
McPherson-Westcott Conjunctival Scissor
Curved, Blunt Tips
10 mm Long Blades With
Max. 5 mm Cutting Edge
Overall Length 11 cm (4 ½")



SS-675-11
Westcott Tenotomy Scissor
Curved, Blunt Tips
14 mm Long Blades With
Max. 8 mm Cutting Edge
Overall Length 11 cm (4 ½")



Micro Scissors
Mikroscheren
Micro-Tijeras
Micro-Ciseaux
Micro-Forbici



Westcott Tenotomy Scissor
Blunt Tips
20 mm Long Blades With
Max. 10 mm Cutting Edge
Overall Length 11 cm (4 1/2")

SS-677-01
Curved Right
SS-677-02
Curved Left



SS-679-11
Tibolt Punctal Scissor
One Conically Shaped Blade With
Micro Grooves & Textured Surface
15 mm Long Blades With
Max. 8 mm Cutting Edge
Overall Length 11.5 cm (4 1/2")



SS-681-11
McPherson-Westcott Stitch Scissor
Curved, Very Sharp Pointed Tips, Small Blades
10 mm Long Blades With
Max. 5 mm Cutting Edge
Overall Length 11 cm (4 1/2")

Micro Scissors
Mikroscheren
Micro-Tijeras
Micro-Ciseaux
Micro-Forbici

OP

OPHTHALMIC SURGERY INSTRUMENTS



SS-683-11
Westcott Stitch Scissor
Curved, Very Sharp Pointed Tips
20 mm Long Blades With
Max. 10 mm Cutting Edge
Overall Length 11.5 cm (4 ½")



SS-685-11
Jaffe Stitch Scissor
Curved, Very Sharp Pointed Tips
13 mm Long Blades With
Max. 7 mm Cutting Edge
Overall Length 11 cm (4 ½")



SS-688-11
Iris Micro Scissor
Straight, Sharp Tips
10 mm Long Blades With
Max. 5 mm Cutting Edge
Overall Length 11 cm (4 ½")

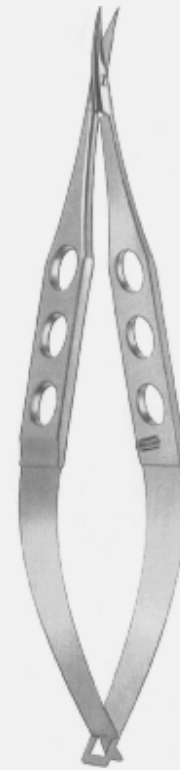

SS-689-11
Iris Micro Scissor
Curved, Sharp Tips
10 mm Long Blades With
Max. 5 mm Cutting Edge
Overall Length 11 cm (4 ½")



Micro Scissors
Mikroscheren
Micro-Tijeras
Micro-Ciseaux
Micro-Forbici



SS-690-11
Fine Micro Scissor
Straight, Sharp Tips
17 mm Long Blades With
Max. 9 mm Cutting Edge
Overall Length 11.5 cm (4 1/2")



SS-691-11
Fine Micro Scissor
Curved, Sharp Tips
17 mm Long Blades With
Max. 9 mm Cutting Edge
Overall Length 11.5 cm (4 1/2")



SS-694-08
Vannas Capsulotomy Scissor
Straight, Sharp Tips
5 mm Long Blades With
Max. 3 mm Cutting Edge
Overall Length 8 cm (3 1/4")



SS-695-08
Vannas Capsulotomy Scissor
Curved, Sharp Tips
5 mm Long Blades With
Max. 3 mm Cutting Edge
Overall Length 8 cm (3 1/4")

Micro Scissors
Mikroscheren
Micro-Tijeras
Micro-Ciseaux
Micro-Forbici

OP

OPHTHALMIC SURGERY INSTRUMENTS



SS-696-08
Vannas Capsulotomy Scissor
Angled Forward, Sharp Tips 5 mm Long Blades With
Max. 3 mm Cutting Edge
Overall Length 8 cm (3 1/4")



SS-697-08
Vannas Capsulotomy Scissor
Angled to Side, Sharp Tips 5 mm Long Blades With
Max. 3 mm Cutting Edge
Overall Length 8 cm (3 1/4")



SS-698-08
Gills-Vannas Capsulotomy Scissor
Straight, Sharp Tips 7 mm Long Blades With
Max. 3 mm Cutting Edge
Overall Length 8 cm (3 1/4")



SS-699-08
Gills-Vannas Capsulotomy Scissor
Curved, Sharp Tips 7 mm Long Blades With
Max. 3 mm Cutting Edge
Overall Length 8 cm (3 1/4")



Micro Scissors
Mikroscheren
Micro-Tijeras
Micro-Ciseaux
Micro-Forbici

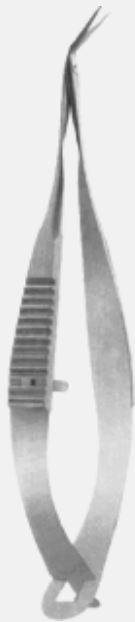

SS-701-08
Gills-Vannas Capsulotomy Scissor
Angled Forward, Sharp Tips 7 mm
Long Blades With Max. 3 mm
Cutting Edge
Overall Length 8 cm (3 1/4")



SS-703-08
McPherson-Vannas Capsulotomy Scissor
Curved, Sharp Tips 8 mm
Long Blades With
Max. 3 mm Cutting Edge
Overall Length 8 cm (3 1/4")



SS-705-08
Holland DALK Scissor
Angled Blades With Blunt Tips
5 mm Long Blades With
Max. 3 mm Cutting Edge
Overall Length 8 cm (3 1/4")

Micro Scissors
Mikroscheren
Micro-Tijeras
Micro-Ciseaux
Micro-Forbici

OP

OPHTHALMIC SURGERY INSTRUMENTS



SS-706-10
Gills-Vannas Micro Scissor
Straight, Extra Thin Blades
Sharp Tips
7 mm Long Blades With
Max. 3 mm Cutting Edge
Overall Length 10.5 cm (4")



SS-707-10
Gills-Vannas Micro Scissor
Curved, Extra Thin Blades
Sharp Tips
7 mm Long Blades With
Max. 3 mm Cutting Edge
Overall Length 10.5 cm (4")



SS-709-10
Gills-Vannas Micro Scissor
Angled Forward, Extra Thin Blades
Sharp Tips
7 mm Long Blades With
Max. 3 mm Cutting Edge
Overall Length 10.5 cm (4")



Micro Scissors
Mikroscheren
Micro-Tijeras
Micro-Ciseaux
Micro-Forbici



SS-710-11
Stern-Gills Micro Scissor
Straight, Extra Thin Blades
Sharp Tips
10 mm Long Blades With
Max. 4 mm Cutting Edge
Overall Length 11 cm (4 1/2")



SS-711-11
Stern-Gills Micro Scissor
Curved, Extra Thin Blades
Sharp Tips
10 mm Long Blades With
Max. 4 mm Cutting Edge
Overall Length 11 cm (4 1/2")



SS-713-11
Stern-Gills Micro Scissor
Angled Forward, Extra Thin Blades
Sharp Tips
10 mm Long Blades With
Max. 4 mm Cutting Edge
Overall Length 11 cm (4 1/2")



SS-715-11
Gills Capsulotomy Scissor
Angled Blades With Curved Sharp Tips
10 mm Long Blades With
Max. 4 mm Cutting Edge
Overall Length 10.5 cm (4 1/2")

Micro Scissors
Mikroscheren
Micro-Tijeras
Micro-Ciseaux
Micro-Forbici

OP

OPHTHALMIC SURGERY INSTRUMENTS



SS-720-20
Straight, Horizontal Opening 20 G



SS-721-20
Curved, Horizontal Opening 20 G
SS-721-23
Curved, Horizontal Opening 23 G



SS-721-30
Angled 30°, Horizontal Opening 20 G



SS-721-45
Angled 45°, Horizontal Opening 20 G

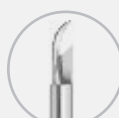

SS-723-23
Vertical Straight, 23 G



SS-723-60
Angled 60°, Horizontal Opening, 20 G



SS-723-80
Angled 80°, Horizontal Opening, 20 G

Vitrectomy Scissor
Overall Length 14 cm (5 1/2")

Micro Scissors
Mikroscheren
Micro-Tijeras
Micro-Ciseaux
Micro-Forbici



SS-725-23

Alio MICS Scissor

Curved, 23 G

Shaft With Horizontal Micro Blades for Cutting Delicate Membranes

Overall Length 14 cm (5 1/2")

Micro Scissors
Mikroscheren
Micro-Tijeras
Micro-Ciseaux
Micro-Forbici

OP

OPHTHALMIC SURGERY INSTRUMENTS



SS-726-12

Vannas Micro Scissor
Straight, 10 mm Long Blades With
Max. 4 mm Cutting Edge
Overall Length 12 cm (4 3/4")



SS-727-12

Vannas Micro Scissor
Curved, 10 mm Long Blades With
Max. 4 mm Cutting Edge
Overall Length 12 cm (4 3/4")



SS-729-12

Vannas Micro Scissor
Angled on Flat, 10 mm Long Blades With
Max. 4 mm Cutting Edge
Overall Length 12 cm (4 3/4")



UltraCut™ TC Stevens Tenotomy Scissor
Overall Length 10.5 cm (4 1/4")



SS-972-10
Straight
Blunt/Blunt



SS-973-10
Curved
Blunt/Blunt



SS-974-10
Straight
Sharp/Sharp



SS-975-10
Straight
Sharp/Sharp



Dissecting Forceps
Anatomische Pinzetten
Pinzas de disección
Pinces à dissection
Pinze per dissezione



FR-050-12
12 cm (4 3/4")

FR-050-15
15 cm (6")

FR-050-18
18 cm (7")

Adson Dressing Forcep
Serrated Tip



FR-052-12
Cross Serrated Tip

Mini-Adson Dressing Forcep
Overall Length 12 cm (4 3/4")

Dissecting Forceps
Anatomische Pinzetten
Pinzas de disección
Pinces à dissection
Pinze per dissezione

OP

OPHTHALMIC SURGERY INSTRUMENTS



FR-054-12
12 cm (4 3/4")

FR-054-15
15 cm (6")

Micro-Adson Dressing Forcep
Cross Serrated Tip

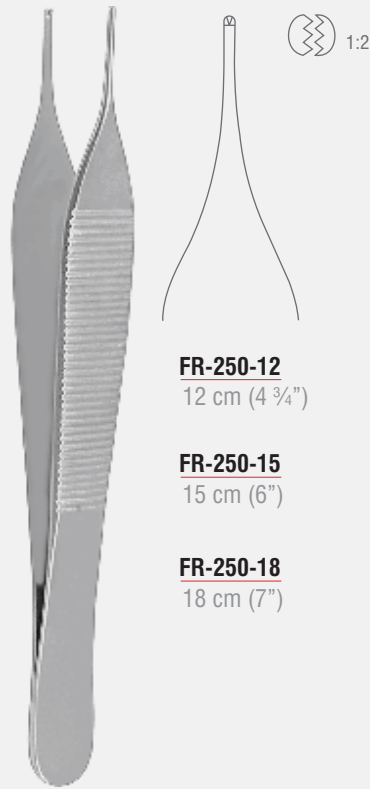

FR-250-12
12 cm (4 3/4")

FR-250-15
15 cm (6")

FR-250-18
18 cm (7")

Adson Dissecting Forcep
1 x 2 Teeth

Dissecting Forceps
Anatomische Pinzetten
Pinzas de disección
Pincès à dissection
Pinze per dissezione

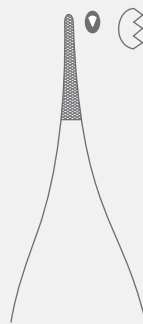

FR-252-12
Straight



FR-253-12
Curved



FR-256-12
12 cm (4 3/4")

FR-256-15
15 cm (6")

Mini-Adson Dissecting Forcep
1 x 2 Teeth, Cross Serrated
Overall Length 12 cm (4 3/4")

Micro-Adson Dissecting Forcep
1 x 2 Teeth

Cilia Forceps
Zilienzange
Pinzas para cilios
Pincès à cils
Pinze Cilia

OP

OPHTHALMIC SURGERY INSTRUMENTS



FR-630-09
Smooth Jaws

Beer Cilia Forcep
Overall Length 9 cm (3 1/2")



FR-632-10
Smooth Jaws

Barraquer Cilia Forcep
Overall Length 10 cm (4")

Micro Forceps
Mikropinzetten
Micro Pinzas
Micro-Pinces
Micro-Pinze

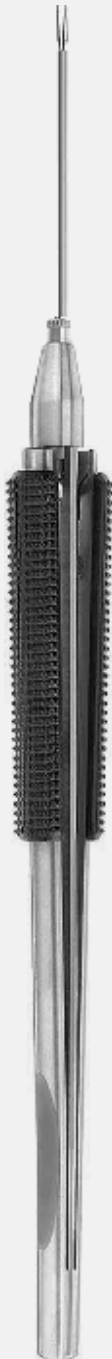

Vitrectomy Forcep
14 cm (5 1/2")



FR-680-20
Straight, Serrated Tip 20 G

FR-680-23
Straight, Serrated Tip 23 G



FR-682-20
Straight, End Grasping Jaws
Horizontal Opening Tip 20 G

FR-682-23
Straight, End Grasping Jaws
Horizontal Opening Tip 23 G



FR-685-20
Smooth Side, Gripping Jaws
Vertical Opening Tip 20 G



FR-687-20
Membrane Peeling, Smooth
45° Angled Jaws, 20 G

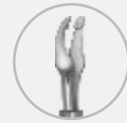

FR-689-23
Asymmetrical Jaws 23 G



FR-690-23
ILM 23 G

Micro Forceps
Mikropinzetten
Micro Pinzas
Micro-Pinces
Micro-Pinze

OP

OPHTHALMIC SURGERY INSTRUMENTS



FR-692-20

ICL Lens Cartridge Loading Forcep

Straight, 20 G
Jaws Feature a Series of Concave
and Convex Surfaces

*ICL® is a registered trademark of
STAAR Surgical Company*



FR-695-23

Alio MICS Capsulorrhexis Forcep

23 G, Curved Shaft With Short Micro-Grasping
Tip Designed For Use Through a Very Small Paracentesis.

Eye Surgery Forceps
Augenchirurgie Pinzetten
Ojo Pinzas Cirugía
Pince de chirurgie oculaire
Eye Pinze Chirurgia



FR-700-01
Straight
10 cm (4")



FR-700-02
Gently Curved
10 cm (4")



FR-700-03
Strongly Curved
9.5 cm (3 3/4")



FR-702-01
Straight
10 cm (4")

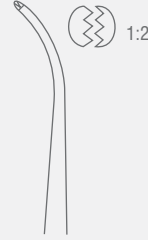

FR-702-02
Gently Curved
10 cm (4")

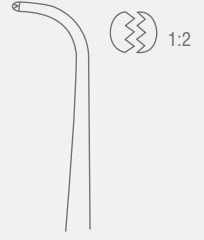

FR-702-03
Strongly Curved
9.5 cm (3 3/4")

Graefe Eye Dressing Forcep
Serrated Tips

Graefe Dissecting Forcep
1 x 2 Teeth

Eye Surgery Forceps
Augenchirurgie Pinzetten
Ojo Pinzas Cirugia
Pince de chirurgie oculaire
Eye Pinze Chirurgia

OP

OPHTHALMIC SURGERY INSTRUMENTS



FR-710-07
Botvin Iris Forcep
Serrated
Overall Length 7.5 cm (3 1/4")



FR-712-07
Botvin Iris Forcep
1 x 2 Teeth
Overall Length 7.5 cm (3 1/4")



FR-714-07
Gills-Colibri Corneal Forcep
Very Fine Pointed Tip, With Tying Platform
Overall Length 7.5 cm (3 1/4")



FR-716-07
Colibri Corneal Forcep
Very Delicate, 1 x 2 Teeth, 0.12 mm
Overall Length 7.5 cm (3 1/4")



FR-718-07
Harms-Colibri Corneal Forcep
Very Delicate, 1 x 2 Teeth, 0.12 mm
With Tying Platform
Overall Length 7.5 cm (3 1/4")



FR-718-07 T
Harms-Colibri Corneal Forcep
Very Delicate, 1 x 2 Teeth, 0.12 mm
With Tying Platform
Overall Length 7.5 cm (3 1/4")



Eye Surgery Forceps
Augenchirurgie Pinzetten
Ojo Pinzas Cirugía
Pince de chirurgie oculaire
Eye Pinze Chirurgia



FR-720-07
Colibri Corneal Forcep
Standard 1 x 2 Teeth
With Tying Platform, 0.4 mm
Overall Length 7.5 cm (3 1/4")



FR-721-07
Pierce-Colibri Corneal Forcep
1 x 1 Teeth, 0.12 mm
Overall Length 7.5 cm (3 1/4")



FR-722-08
Hoskin Tissue Forcep
Straight, 1 x 1 Teeth
Overall Length 8 cm (3 1/4")

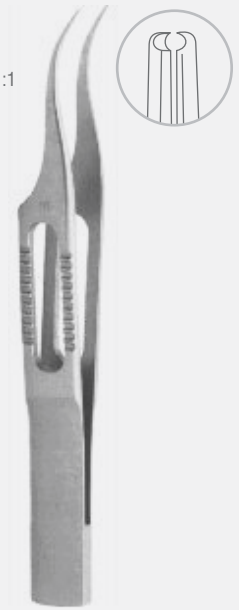

FR-723-08
Hoskin Tissue Forcep
Curved, 1 x 1 Teeth
Overall Length 8 cm (3 1/4")

Eye Surgery Forceps
Augenchirurgie Pinzetten
Ojo Pinzas Cirugia
Pince de chirurgie oculaire
Eye Pinze Chirurgia

OP

OPHTHALMIC SURGERY INSTRUMENTS



FR-724-10
Fechtner Conjunctival Forcep
Very Delicate Ring Shaped Tips
With Tying Platform
Overall Length 10.5 cm (4")



FR-726-11
Castroviejo-Colibri Corneal Forcep
Very Delicate 1 x 2 Teeth, 0.12 mm
Overall Length 11 cm (4 1/4")



FR-728-11
Harms-Colibri Corneal Forcep
Very Delicate 1 x 2 Teeth, 0.12 mm
With Tying Platform
Overall Length 11 cm (4 1/4")



Eye Surgery Forceps
Augenchirurgie Pinzetten
Ojo Pinzas Cirugía
Pince de chirurgie oculaire
Eye Pinze Chirurgia



FR-730-08
Bonn Corneal Forcep
Very Delicate 1 x 2 Teeth 0.12 mm
Overall Length 8.5 cm (4")



FR-732-10
Bonn Corneal Forcep
Very Delicate 1 x 2 Teeth
With Tying Platform, 0.12 mm
Overall Length 10 cm (4")

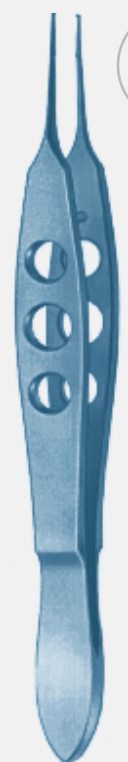

FR-732-10 T
Bonn Corneal Forcep
Very Delicate 1 x 2 Teeth
With Tying Platform, 0.12 mm, Titanium
Overall Length 10 cm (4")



FR-734-08
Bonn Corneal Forcep
Very Delicate, Serrated
Overall Length 8.5 cm (3 1/4")



TITANIUM

Eye Surgery Forceps
Augenchirurgie Pinzetten
Ojo Pinzas Cirugia
Pince de chirurgie oculaire
Eye Pinze Chirurgia

OP

OPHTHALMIC SURGERY INSTRUMENTS



FR-736-10
McPherson Suture Tying Forcep
Straight, 1 x 2 Teeth
With Tying Platform, 0.4 mm
Overall Length 10.5 cm (4")



FR-737-10
McPherson Suture Tying Forcep
Angled, 1 x 2 Teeth
With Tying Platform, 0.4 mm
Overall Length 10 cm (4")



FR-740-10
Kelman-McPherson Tissue Forcep
Angled, 1 x 2 Teeth
With Tying Platform, 0.3 mm
Overall Length 10 cm (4")

Eye Surgery Forceps
Augenchirurgie Pinzetten
Ojo Pinzas Cirugía
Pince de chirurgie oculaire
Eye Pinze Chirurgia



FR-742-10
Hoffer-McPherson Tissue Forcep
Very Delicate, 1 x 2 Teeth
11 mm, 0.12 mm
Overall Length 10 cm (4")

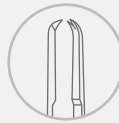

Castroviejo Suture Tying Forcep
1 x 2 Teeth, With Tying Platform
Overall Length 11 cm (4 1/4")

- FR-750-01** 0.12 mm
- FR-750-03** 0.3 mm
- FR-750-05** 0.5 mm
- FR-750-09** 0.9 mm

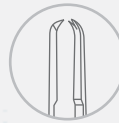

FR-750-01 T
Castroviejo Suture Tying Forcep
1 x 2 Teeth, With Tying Platform
0.12 mm, Titanium
Overall Length 11 cm (4 1/4")



Eye Surgery Forceps
Augenchirurgie Pinzetten
Ojo Pinzas Cirugia
Pince de chirurgie oculaire
Eye Pinze Chirurgia

OP

OPHTHALMIC SURGERY INSTRUMENTS



1:2

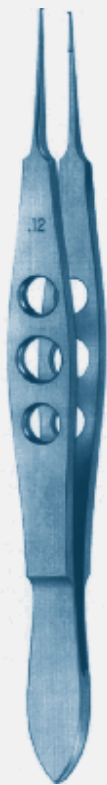

1:2



1:2

Castroviejo Suture Tying Forcep

Angled, 1 x 2 Teeth
With Tying Platform
Overall Length 11 cm (4 1/4")

FR-751-01 T

Castroviejo Suture Tying Forcep
Angled, 1 x 2 Teeth, With Tying Platform
0.12 mm, Titanium
Overall Length 11 cm (4 1/4")

FR-752-05

Stern-Castroviejo Suture Tying Forcep
1 x 2 Teeth, 0.5 mm
Overall Length 11 cm (4 1/4")

- FR-751-01** 0.12 mm
- FR-751-03** 0.3 mm
- FR-751-05** 0.5 mm
- FR-751-09** 0.9 mm



Eye Surgery Forceps
Augenchirurgie Pinzetten
Ojo Pinzas Cirugía
Pince de chirurgie oculaire
Eye Pinze Chirurgia



FR-754-10
Girard Corneoscleral Forcep
1 x 2 Teeth With Tying Platform
For Right Hand, 0.12 mm
Overall Length 10.5 cm (4")



FR-756-10
Girard Corneoscleral Forcep
1 x 2 Teeth With Tying Platform
For Left Hand, 0.12 mm
Overall Length 10.5 cm (4")



FR-758-08
0.3 mm Delicate
1 x 2 Teeth



FR-760-08
0.8 mm Standard
1 x 2 Teeth

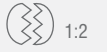

Bishop-Harmon Iris Forcep
Overall Length 8.5 cm (3 1/4")

Eye Surgery Forceps
Augenchirurgie Pinzetten
Ojo Pinzas Cirugia
Pince de chirurgie oculaire
Eye Pinze Chirurgia

OP

OPHTHALMIC SURGERY INSTRUMENTS



FR-762-09
Bishop-Harmon Dressing Forcep
Cross Serrated Jaws
Overall Length 8.5 cm (3 ¼")



FR-764-09
St. Martin's Suture Tying Forcep
1 x 2 Teeth
With Tying Platform
Overall Length 9 cm (3 ½")



FR-765-09
Paufique Suture Tying Forcep
1 x 2 Teeth
With Tying Platform
Overall Length 9 cm (3 ½")

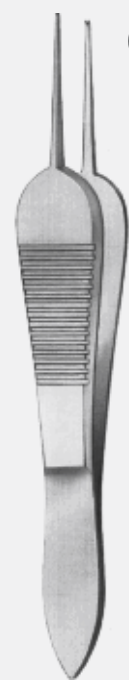

FR-766-09
Sauer Fixation Forcep
1 x 2 Teeth, 0.3 mm
Overall Length 9 cm (3 ½")

Eye Surgery Forceps
Augenchirurgie Pinzetten
Ojo Pinzas Cirugía
Pince de chirurgie oculaire
Eye Pinze Chirurgia



FR-768-09
Manhattan Eye & Ear Fixation Forcep
1 x 2 Teeth, 0.3 mm, With Tying Platform
Overall Length 9 cm (3 1/2")



FR-770-11
Elschnig Fixation Forcep
1 x 2 Teeth
Overall Length 11 cm (4 1/4")



FR-772-01
Gaefe Fixation Forcep
Without Lock
Overall Length 11 cm (4 1/4")



FR-772-02
Gaefe Fixation Forcep
With Lock
Overall Length 11 cm (4 1/4")

Eye Surgery Forceps
Augenchirurgie Pinzetten
Ojo Pinzas Cirugia
Pince de chirurgie oculaire
Eye Pinze Chirurgia

OP

OPHTHALMIC SURGERY INSTRUMENTS



FR-774-10
Green Fixation Forcep
9.0 mm
Overall Length 10.5 cm (4")



FR-774-11
Troutman Superior Rectus Forcep
Angled, 1 x 2 Teeth
Overall Length 11 cm (4 1/4")



Lester Fixation Forcep
Overall Length 9.5 cm (3 3/4")



FR-776-01
Angled
1 x 2 Teeth



FR-776-02
Angled
2 x 3 Teeth





Eye Surgery Forceps
Augenchirurgie Pinzetten
Ojo Pinzas Cirugía
Pince de chirurgie oculaire
Eye Pinze Chirurgia



FR-777-01
Moody Fixation Forcep
Curved Right
Overall Length 11 cm (4 1/4")



FR-777-02
Moody Fixation Forcep
Curved Left
Overall Length 11 cm (4 1/4")



FR-780-10
McPherson Suture Tying Forcep
Straight, With Tying Platform, 5 mm
Overall Length 10 cm (4")



FR-780-10 T
McPherson Suture Tying Forcep
Straight, With Tying Platform, 5 mm
Titanium
Overall Length 10 cm (4")



Eye Surgery Forceps
Augenchirurgie Pinzetten
Ojo Pinzas Cirugia
Pince de chirurgie oculaire
Eye Pinze Chirurgia

OP

OPHTHALMIC SURGERY INSTRUMENTS



FR-781-10

McPherson Suture Tying Forcep
Angled, With Tying Platform, 5 mm
Overall Length 10 cm (4")



FR-781-10 T

McPherson Suture Tying Forcep
Angled, With Tying Platform, 5 mm Titanium
Overall Length 10 cm (4")



Eye Surgery Forceps
Augenchirurgie Pinzetten
Ojo Pinzas Cirugía
Pince de chirurgie oculaire
Eye Pinze Chirurgia



FR-784-10
Kelman-McPherson Suture Tying Forcep
Angled, With Tying Platform, 7.5 mm
Overall Length 10 cm (4")

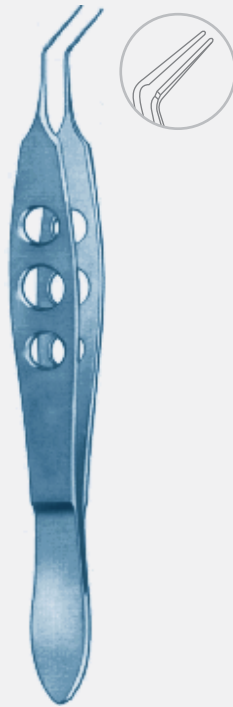

FR-784-10 T
Kelman-McPherson Suture Tying Forcep
Angled, With Tying Platform, 7.5 mm Titanium
Overall Length 10 cm (4")



FR-790-10
Kurstin Flap Stretching Forcep
Disc Shaped, Serrated Jaws
Overall Length 10.5 cm (4")



FR-793-10
Buratto LASIK Flap Forcep
Curved, Disc Shaped, Serrated Jaws
Overall Length 10.5 cm (4")

Eye Surgery Forceps
Augenchirurgie Pinzetten
Ojo Pinzas Cirugia
Pince de chirurgie oculaire
Eye Pinze Chirurgia



FR-795-10
Mendez Multipurpose LASIK Forcep
Angled, Spatulated Jaws & Tip
Overall Length 10 cm (4")



FR-797-10
Kraff Capsule Tag Forcep
Angled, 11 mm, 1.5 mm
Overall Length 10.5 cm (4")



FR-801-10
Ultrata Capsulorrhexis Forcep
Very Delicate Triangular Grasping Tips Extremely Thin, 11 mm
Over Length 10.5 cm (4")

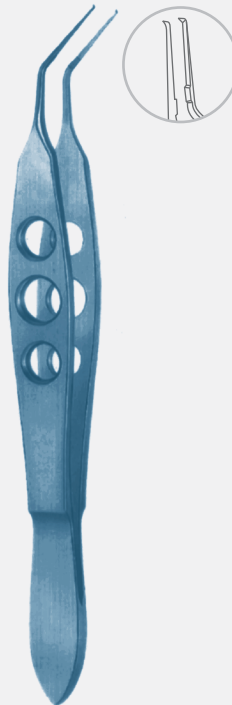

FR-801-10 T
Ultrata Capsulorrhexis Forcep
Very Delicate Triangular Grasping Tips Extremely Thin, 11 mm, Titanium
Overall Length 10.5 cm (4")





Eye Surgery Forceps
Augenchirurgie Pinzetten
Ojo Pinzas Cirugía
Pince de chirurgie oculaire
Eye Pinze Chirurgia



FR-803-10
Jaffe Capsulorhexis Forcep
Very Delicate Round Grasping Tip
Extremely Thin, 11 mm
Overall Length 10.5 cm (4")



FR-805-10
O'Gawa-Utrata Capsulorhexis Forcep
Very Delicate, Round Grasping Tips
Extremely Thin
Overall Length 11.5 cm (4 1/2")



FR-807-11
Inamura Capsulorhexis Forcep
Delicate Tapered 12 mm Long Shanks
Overall Length 11.5 cm (4 1/2")



FR-809-10
Masket Capsulorhexis Forcep
With Very Delicate Triangle Grasping Tip & Very
Delicate Vaulted Shanks, Length 11 mm
Overall Length 11.5 cm (4 1/2")



Eye Surgery Forceps
Augenchirurgie Pinzetten
Ojo Pinzas Cirugia
Pince de chirurgie oculaire
Eye Pinze Chirurgia

OP

OPHTHALMIC SURGERY INSTRUMENTS



FR-810-10
Jaffe Suture Tying Forcep
Straight, Very Delicate
Smooth Jaws, 6 mm
Overall Length 10.5 cm (4")



FR-811-10
Jaffe Suture Tying Forcep
Curved, Very Delicate
Smooth Jaws 6 mm
Overall Length 10.5 cm (4")



FR-816-10
Tennant Suture Tying Forcep
Straight, Round Handle With
Guide Pin Extra Delicate
Smooth Jaws, 6 mm
Overall Length 10.5 cm (4")

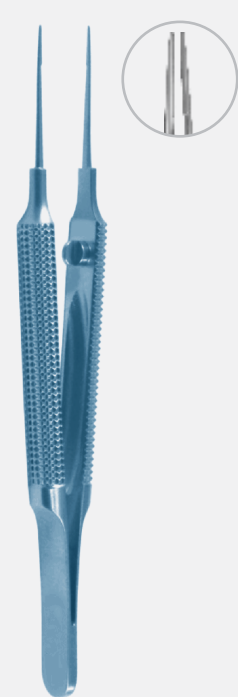

FR-816-10 T
Tennant Suture Tying Forcep
Straight, Round Handle With
Guide Pin Extra Delicate Smooth
Jaws, 6 mm
Overall Length 10.5 cm (4")



Eye Surgery Forceps
Augenchirurgie Pinzetten
Ojo Pinzas Cirugía
Pince de chirurgie oculaire
Eye Pinze Chirurgia



FR-817-10
Tennant Suture Tying Forcep
Curved, Round Handle With Guide Pin
Extra Delicate Smooth Jaws, 6 mm
Overall Length 10.5 cm (4")

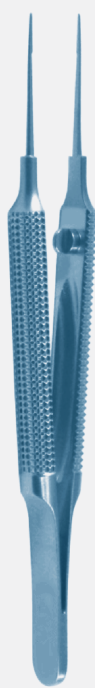

FR-817-10 T
Tennant Suture Tying Forcep
Curved, Round Handle With Guide Pin
Extra Delicate Smooth Jaws, 6 mm
Titanium
Overall Length 10.5 cm (4")



FR-820-10
Harms Suture Tying Forcep
Straight
Overall Length 10.5 cm (4")



FR-821-10
Harms Suture Tying Forcep
Curved
Overall Length 10.5 cm (4")

Eye Surgery Forceps
Augenchirurgie Pinzetten
Ojo Pinzas Cirugia
Pince de chirurgie oculaire
Eye Pinze Chirurgia



FR-824-10
Helveston Suture Tying Forcep
Straight
Overall Length 10.5 cm (4")



FR-825-10
Fine Suture Tying Forcep
Curved
Overall Length 10.5 cm (4")

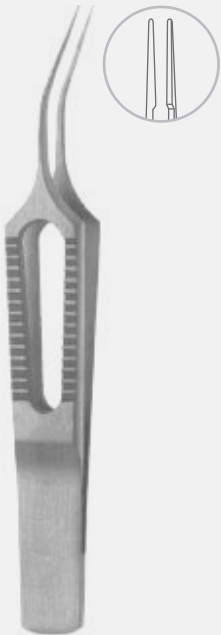

FR-827-08
Gerl Suture Tying Forcep
Smooth Jaws, Curved Shanks, 6 mm
Overall Length 8.5 cm (3 1/4")

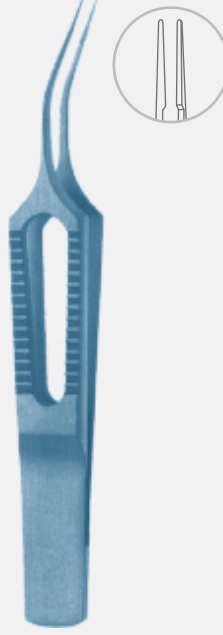

FR-827-08 T
Gerl Suture Tying Forcep
Smooth Jaws, Curved Shanks, 6 mm
Titanium
Overall Length 8.5 cm (3 1/4")





Eye Surgery Forceps
Augenchirurgie Pinzetten
Ojo Pinzas Cirugía
Pince de chirurgie oculaire
Eye Pinze Chirurgia



FR-830-10
Gradle Cilia Forcep
Smooth Jaws
Overall Length 10 cm (4")



Bonaccolto Conjunctival Forcep
Overall Length 10 cm (4")
FR-834-12
Longitudinal Serrated Jaws
With Cross Serrated Tips, 1.2 mm

FR-834-17
Longitudinal Serrated Jaws
With Cross Serrated Tips, 1.7 mm



FR-836-10
Lister Conjunctival Forcep
1 x 2 Teeth
Overall Length 10 cm (4")



FR-838-10
Moorfield Conjunctival Forcep
Overall Length 10 cm (4")

Eye Surgery Forceps
Augenchirurgie Pinzetten
Ojo Pinzas Cirugia
Pince de chirurgie oculaire
Eye Pinze Chirurgia

OP

OPHTHALMIC SURGERY INSTRUMENTS



Nugent Utility Forcep
Overall Length 10 cm (4")

FR-840-10
Smooth Jaws

FR-842-10
Serrated Jaws

FR-844-11
Lister Utility Forcep
Serrated Jaws
1 x 2 Teeth
Overall Length 11 cm (4 1/4")

FR-847-08
Scleral Plug Removing Forcep
Overall Length 8.5 cm - (3 1/2")

FR-846-10
Gold Punctal Plug Forcep
With Longitudinal Groove
Pointed Tip
Overall Length 11 cm (4 1/4")



Eye Surgery Forceps
Augenchirurgie Pinzetten
Ojo Pinzas Cirugía
Pince de chirurgie oculaire
Eye Pinze Chirurgia



FR-848-11
Osher Iris Forcep
Very Fine Textured Jaws
Overall Length 11 cm (4 1/4")



FR-850-11
Foreign Body Forcep
Straight
Overall Length 8.5 cm (3 1/4")



FR-855-11
Jaffe Utility Forcep
Curved, Very Delicate
Smooth Jaws
Overall Length 11 cm (4 1/4")



FR-857-11
Castroviejo Capsule Forcep
Overall Length 11 cm (4 1/4")



FR-859-11
Arruga Capsule Forcep
Curved, Very Delicate
Overall Length 11 cm (4 1/4")

Eye Surgery Forceps
Augenchirurgie Pinzetten
Ojo Pinzas Cirugia
Pince de chirurgie oculaire
Eye Pinze Chirurgia

OP

OPHTHALMIC SURGERY INSTRUMENTS



FR-861-11
Akahoshi Phaco PreChopper
Delicate Jaws With Sharp Tip
4.5 mm
Overall Length 11 cm (4 1/4")



FR-863-11
Ernest Nucleus Cracker
Extra Delicate Cross Action
Serrated Paddle Tip
Overall Length 11 cm (4 1/4")



FR-867-11
Dodick Nucleus Cracker
Cross Action, Longitudinally
Serrated Paddle Shaped Jaws
Overall Length 11 cm (4 1/4")



FR-869-10
Alfonso Nucleus Grasping Forcep
With Two Short Rows of Delicate
Interlocking Teeth
Overall Length 10.5 cm (4")

Eye Surgery Forceps
Augenchirurgie Pinzetten
Ojo Pinzas Cirugía
Pince de chirurgie oculaire
Eye Pinze Chirurgia



FR-871-11
Rosenwasser Donor Lamella Inserting Forcep
With Vaulted Shanks
Overall Length 11 cm (4 1/4")



FR-875-11
Dodick IOL Folding Forcep
For Short IOLs
Overall Length 11 cm (4 1/4")



FR-877-10
Livernois IOL Folding Forcep
Concave Jaw Surfaces, For Soft IOLs
Overall Length 11 cm (4 1/4")

Eye Surgery Forceps
Augenchirurgie Pinzetten
Ojo Pinzas Cirugia
Pince de chirurgie oculaire
Eye Pinze Chirurgia

OP

OPHTHALMIC SURGERY INSTRUMENTS



FR-879-10
Steinert IOL Inserting Forcep
Conically Shaped Jaws
Overall Length 10 cm (4")



FR-882-10
Livernois IOL Holding Forcep
Straight, Highly Polished Round
Jaws For Holding Soft IOLs
Overall Length 10.5 cm (4")



FR-883-10
Livernois IOL Holding Forcep
Angled, Highly Polished Round
Jaws For Holding Soft IOLs
Overall Length 10.5 cm (4")



Eye Surgery Forceps
Augenchirurgie Pinzetten
Ojo Pinzas Cirugía
Pince de chirurgie oculaire
Eye Pinze Chirurgia



FR-885-10
Livernois-McDonald IOL Inserting Forcep
Concave Jaws, 5.0 mm
Overall Length 10.5 cm (4")



FR-887-10
Faulkner Lens Holding Forcep
Round, Smooth Jaws
Overall Length 10 cm (4")



FR-889-10
Buratto IOL Inserting Forcep
Extra Delicate Highly Polished Convex Jaws
For Soft IOLs
Overall Length 10 cm (4")

Eye Surgery Forceps
Augenchirurgie Pinzetten
Ojo Pinzas Cirugia
Pince de chirurgie oculaire
Eye Pinze Chirurgia

OP

OPHTHALMIC SURGERY INSTRUMENTS



FR-891-12
Bechert Lens Holding Forcep
Very Delicate Flat Jaws
Overall Length 12.5 cm (5")



FR-893-12
Kratz Lens Holding Forcep
Very Delicate Narrow Jaws
Overall Length 12.5 cm (5")



FR-895-11
Blaydes Lens Holding Forcep
Very Delicate Narrow Jaws
Angled 45°
Overall Length 11.5 cm (4 ½")



FR-897-12
Shepard Lens Holding Forcep
Gently Curved, Duckbill Shaped Jaws
Overall Length 12.5 cm (5")



Eye Surgery Forceps
Augenchirurgie Pinzetten
Ojo Pinzas Cirugía
Pince de chirurgie oculaire
Eye Pinze Chirurgia



FR-899-12
Clayman Lens Holding Forcep
Gently Curved, Blades With
Delicately Angled Jaws
Overall Length 12.5 cm (5")

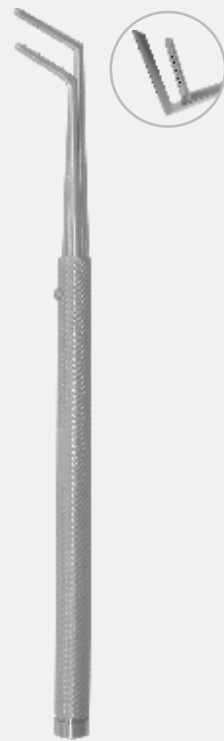

FR-900-10
Bangerter Muscle Clamp
With 10 Delicate Teeth
and Push Button
Overall Length 10 cm (4")



FR-901-01
Jameson Muscle Forcep
Right, With Slide Lock,
4 Teeth, Child Size
Overall Length 9.5 cm (3 3/4")



FR-901-02
Jameson Muscle Forcep
Left, With Slide Lock,
4 Teeth, Child Size
Overall Length 9.5 cm (3 3/4")

Eye Surgery Forceps
Augenchirurgie Pinzetten
Ojo Pinzas Cirugia
Pince de chirurgie oculaire
Eye Pinze Chirurgia

OP

OPHTHALMIC SURGERY INSTRUMENTS



FR-903-01
Jameson Muscle Forcep
Right, With Slide Lock,
6 Teeth, Adult Size
Overall Length 10 cm (4")



FR-903-02
Jameson Muscle Forcep
Left, With Slide Lock,
6 Teeth, Adult Size
Overall Length 10 cm (4")



FR-905-20
Berke Ptosis Forcep
Longitudinally Grooved
Jaws, With Side Lock, 20 mm
Overall Length 11 cm (4 1/4")



FR-905-27
Berke Ptosis Forcep
Longitudinally Grooved
Jaws, With Side Lock, 27 mm
Overall Length 11 cm (4 1/4")



Eye Surgery Forceps
Augenchirurgie Pinzetten
Ojo Pinzas Cirugía
Pince de chirurgie oculaire
Eye Pinze Chirurgia



FR-906-10
Putterman-Muellers Muscle Conjunctival Resection Ptosis Clamp
With Slide Lock,
Overall Length 10 cm (4")



FR-907-11
Watzke Sleeve Spreading Forcep
Jaw Length 10 mm
Overall Length 11.5 cm (4 1/2")



FR-908-10
Erhardt Lid Forcep
Overall Length 10.5 cm (4")

Eye Surgery Forceps
Augenchirurgie Pinzetten
Ojo Pinzas Cirugia
Pince de chirurgie oculaire
Eye Pinze Chirurgia

OP

OPHTHALMIC SURGERY INSTRUMENTS

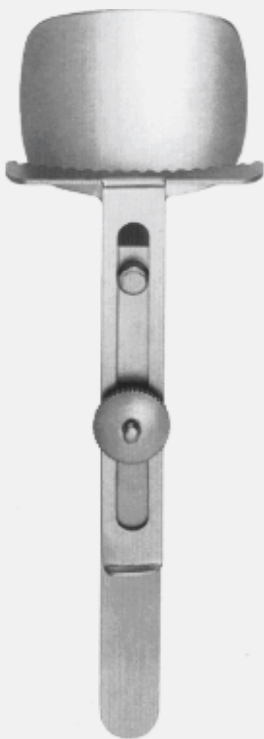

FR-910-09
Downes Lid Clamp
Overall Length 9.5 cm (3 3/4")



FR-912-08
Lambert Chalazion Forcep
Round Jaws, Ø 8.0 mm
Overall Length 9 cm (3 1/2")



FR-912-12
Hunt Chalazion Forcep
Round Jaws, Ø 12.0 mm
Overall Length 9.5 cm (3 3/4")



FR-914-09
Baird Chalazion Forcep
Small, Oval Jaws, 11 x 8 mm
Overall Length 9.5 cm (3 3/4")

Eye Surgery Forceps
Augenchirurgie Pinzetten
Ojo Pinzas Cirugía
Pince de chirurgie oculaire
Eye Pinze Chirurgia



FR-916-09
Francis Chalazion Forcep
Medium, Oval Jaws, 14 x 11 mm
Overall Length 9.5 cm (3 3/4")



Desmarres Chalazion Forcep
Overall Length 9 cm (3 1/2")
FR-918-09
Large, Oval Jaws, 20 x 13 mm

FR-919-09
Large, Oval Jaws, 25 x 13 mm



FR-920-09
Wies Chalazion Forcep
Grooved Upper Jaws
Overall Length 9.5 cm (3 3/4")



FR-921-09
Lordan Chalazion Forcep
Triangular Jaws
Overall Length 9.5 cm (3 3/4")

Eye Surgery Forceps
Augenchirurgie Pinzetten
Ojo Pinzas Cirugia
Pince de chirurgie oculaire
Eye Pinze Chirurgia

OP

OPHTHALMIC SURGERY INSTRUMENTS



FR-922-01
Ayer Chalazion Forcep
Round Jaws, Ø 12.0 mm
Overall Length 9.5 cm (3 ¾")



FR-923-01
Desmarres Entropian Forcep
Right
Overall Length 10 cm (4")



FR-923-02
Desmarres Entropian Forcep
Left
Overall Length 10 cm (4")

Bulldog Clamps, Haemostatic Forceps
Bulldogklemmen, Arterienklemmen
Clamps Bulldog, Pinzas hemostáticas
Clamps Bulldog, Pince hémostatiques
Pinze Bulldog, Pinze emostatische



AF-062-03
Straight



AF-063-03
Curved

Dieffenbach Bulldog Clamp
3.5 cm (1 1/2")



AF-140-10
Straight
10 cm (4")



AF-141-10
Curved
9.5 cm (3 3/4")

Hartmann Haemostatic Forcep



AF-160-12
Straight
12.5 cm (4 3/4")



AF-161-12
Curved
12 cm (4 3/4")

Halsted-Mosquito Haemostatic Forcep

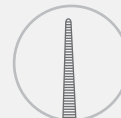

AF-170-10
Straight
10 cm (4")



AF-171-10
Curved
9.5 cm (3 3/4")

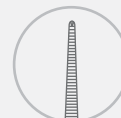

AF-172-10
Straight
1 x 2 Teeth
10 cm (4")



AF-173-10
Curved
1 x 2 Teeth
10 cm (4")

Micro-Mosquito Haemostatic Forcep

Towel Clamps
Tuchklemmen
Pinzas de campo
Pincès à champs
Pinze fissatele

OP

OPHTHALMIC SURGERY INSTRUMENTS



AF-761-05
Jones Towel Clamp
Sharp
Overall Length 5.5 cm (2 1/2")

AF-761-09
Sharp
Overall Length 8.5 cm (3 1/4")



AF-773-08
Backhaus Towel Clamp
Overall Length 9 cm (3 1/2")



Sphenoid Bone Punches
Keilbeinstanzen
Pinzas sacabocadas para esfenoides
Pinces emporte-pièces pour sinus sphénoïdal
Pinze taglienti per seno sfenoidale



Citelli Mastoid Rongeur
Shaft Length 17 cm (6 3/4")



OT-751-02
Bite Size 2.0 mm



OT-751-03
Bite Size 3.0 mm



Kerrison Sphenoid Punch

RH-305-03
Up Cutting
Bite Size Ø 3.0 mm x 3.0 mm
Shaft Length 14 cm (5 1/2")

RH-305-04
Up Cutting
Bite Size Ø 4.0 mm x 4.0 mm
Shaft Length 9 cm (3 1/2")

RH-305-05
Up Cutting
Bite Size Ø 5.0 mm x 5.0 mm
Shaft Length 9 cm (3 1/2")

RH-305-06
Up Cutting
Bite Size Ø 6.0 mm x 6.0 mm
Shaft Length 9 cm (3 1/2")

Septum Chisels, Septum Gouges, Nasal Specula
Septummeißel, Septum-Hohlmeißel, Nasenspekula
Cinceles para tabique nasal, Gubias para tabique nasal, Espéculos nasales
Élévateurs pour le périoste, Gouges pour la cloison nasale, Spéculums nasaux
Elevatori per il periostio, Sgorbie per il setto nasale, Specoli nasali



RH-033-01

27 mm, Fig. 1

RH-033-02

31 mm, Fig. 2

RH-033-03

35 mm, Fig. 3

Hartmann-Halle Nasal Speculum

Overall Length 15.5 cm (6")



RH-475-18

Freer Septum Elevator

Double Ended, Sharp/Blunt, Blades Size 5.0 mm, 5.0 mm
Overall Length 18.5 cm (7 1/4")



RH-600-16

Freer Septum Chisel

Straight, 4.0 mm
Overall Length 16.5 cm (6 1/2")



RH-601-16

Freer Septum Chisel

Curved, 4.0 mm
Overall Length 16.5 cm (6 1/2")



RH-604-16

West Septum Chisel

Overall Length 16 cm (6 1/4")



RH-605-16

West Septum Gouge

Overall Length 16 cm (6 1/4")



Micro Needle Holders
Mikro-Nadelhalter
Micro Porta-agujas
Micro Porte-aiguilles
Micro Portaghi



Halsey Needle Holder
Overall Length 13 cm (5")



SU-024-13
Smooth Jaws



SU-026-13
Cross Serrated Jaws



Heavy Pattern



SU-040-13
Brown Needle Holder
Overall Length 13 cm (5")



McPherson Micro Needle Holder
Very Delicate Tips, Without Lock
Overall Length 10 cm (4")



SU-200-10
Straight



SU-201-10
Curved



SU-202-10
Straight



SU-203-10
Curved



McPherson Micro Needle Holder
Very Delicate Tips, With Lock
Overall Length 10 cm (4")

Micro Needle Holders
Mikro-Nadelhalter
Micro Porta-agujas
Micro Porte-aiguilles
Micro Portaghi

OP

OPHTHALMIC SURGERY INSTRUMENTS



SU-210-14
Straight



SU-211-14
Curved



SU-212-14
Straight



SU-213-14
Curved

Castroviejo Micro Needle Holder
Delicate Tips, Without Lock
Overall Length 14 cm (5 1/2")

Castroviejo Micro Needle Holder
Delicate Tips, With Lock
Overall Length 14 cm (5 1/2")



Micro Needle Holders
Mikro-Nadelhalter
Micro Porta-agujas
Micro Porte-aiguilles
Micro Portaghi

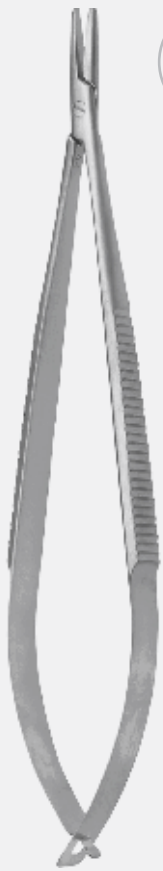

SU-220-14
Straight



SU-221-14
Curved



SU-222-14
Straight



SU-223-14
Curved

Castroviejo Micro Needle Holder
Standard Tips, Without Lock
Overall Length 14 cm (5 1/2")

Castroviejo Micro Needle Holder
Standard Tips, With Lock
Overall Length 14 cm (5 1/2")

Micro Needle Holders
Mikro-Nadelhalter
Micro Porta-agujas
Micro Porte-aiguilles
Micro Portaghi

OP

OPHTHALMIC SURGERY INSTRUMENTS



SU-300-10
Straight



SU-301-10
Curved



SU-310-10
Straight
With Lock
10.5 cm (4")



SU-310-11
Straight
With Lock
11.5 cm (4 ½")



SU-311-10
Curved
With Lock
10.5 cm (4")



SU-311-11
Curved
With Lock
11.5 cm (4 ½")

Barraquer-Troutman Micro Needle Holder
Round Handle, Extra Delicate Tips, Without Lock
Overall Length 10 cm (4")

Barraquer-Troutman Micro Needle Holder
Round Handle, Very Delicate Tips

Micro Needle Holders
Mikro-Nadelhalter
Micro Porta-agujas
Micro Porte-aiguilles
Micro Portaghi



SU-313-11
Curved, Delicate
Round Handle

Barraquer Micro Needle Holder
Overall Length 11.5 cm (4 1/2")



SU-315-11
Curved, Delicate
Round Handle
With Lock

Barraquer Micro Needle Holder
Overall Length 11.5 cm (4 1/2")



SU-315-11 T
Curved, Delicate
Round Handle
With Lock, Titanium

Barraquer Micro Needle Holder
Overall Length 11.5 cm (4 1/2")



Micro Needle Holders
Mikro-Nadelhalter
Micro Porta-agujas
Micro Porte-aiguilles
Micro Portaghi

OP

OPHTHALMIC SURGERY INSTRUMENTS



SU-320-13
Straight



SU-321-13
Curved

Barraquer Micro Needle Holder
Round Handle, Very Delicate Tips, Without Lock
Overall Length 13 cm (5")



SU-322-13
Straight



SU-323-13
Curved

Barraquer Micro Needle Holder
Round Handle, Very Delicate Tips, With Lock
Overall Length 13 cm (5")

Micro Needle Holders
Mikro-Nadelhalter
Micro Porta-agujas
Micro Porte-aiguilles
Micro Portaghi



SU-331-14
Straight
Very Delicate
Round Handle

Barraquer Micro Needle Holder
Overall Length 14 cm (5 1/2")



SU-331-14 T
Straight
Very Delicate
Round Handle, Titanium

Barraquer Micro Needle Holder
Overall Length 14 cm (5 1/2")



SU-333-14
Curved
Very Delicate
Round Handle
With Lock

Barraquer Micro Needle Holder
Overall Length 14 cm (5 1/2")



Micro Needle Holders
Mikro-Nadelhalter
Micro Porta-agujas
Micro Porte-aiguilles
Micro Portaghi

OP

OPHTHALMIC SURGERY INSTRUMENTS



SU-333-14 T
Curved
Very Delicate
Round Handle
With Lock, Titanium

Barraquer Micro Needle Holder
Overall Length 14 cm (5 1/2")



SU-341-12
Without Lock



SU-343-12
With Lock

Troutman Micro Needle Holder
Round Handle, Strongly Curved Delicate Tips
Overall Length 12 cm (4 3/4")



Micro Needle Holders
Mikro-Nadelhalter
Micro Porta-agujas
Micro Porte-aiguilles
Micro Portaghi



SU-500-13

Curved
Smooth Jaws
Round Handle
Without Lock

UltraGrip™ TC Barraquer Micro Needle Holder
Overall Length 13 cm (5")

ULTRA GRIP X™



SU-502-13

Curved
Smooth Jaws
Round Handle
With Lock

UltraGrip™ TC Barraquer Micro Needle Holder
Overall Length 13 cm (5")

ULTRA GRIP X™



Micro Needle Holders
Mikro-Nadelhalter
Micro Porta-agujas
Micro Porte-aiguilles
Micro Portaghi

OP

OPHTHALMIC SURGERY INSTRUMENTS



SU-510-14
Straight
With Lock

UltraGrip™ TC Castroviejo Micro Needle Holder
Overall Length 14.5 cm (5 ¾")

ULTRA GRIP[®]



SU-511-14
Curved
With Lock

UltraGrip™ TC Castroviejo Micro Needle Holder
Overall Length 14.5 cm (5 ¾")

ULTRA GRIP[®]



Micro Needle Holders
Mikro-Nadelhalter
Micro Porta-agujas
Micro Porte-aiguilles
Micro Portaghi



SU-512-14
Straight, Smooth Jaws
With Lock

UltraGrip™ TC Castroviejo Micro Needle Holder
Overall Length 14.5 cm (5 ¾")

ULTRA GRIP X



SU-513-14
Curved, Smooth Jaws
With Lock

UltraGrip™ TC Castroviejo Micro Needle Holder
Overall Length 14.5 cm (5 ¾")

ULTRA GRIP X



Calipers
Schieblehren
Calibres
Pieds à coulisse
Calibro



DI-850-20
Castroviejo Caliper
Straight
Measuring Range 20 mm
Overall Length 14.5 cm (5 3/4")



DI-880-15
Ruler
Graduated in mm & inches
Measuring Range 150 mm
Overall Length 10 cm (4")



RT-048-01
Fig. 1

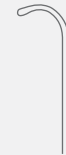

RT-048-02
Fig. 2

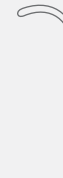

RT-048-03
Fig. 3

Graefe Nerve Hook
Blunt
Overall Length 14 cm (5 1/2")



RT-066-13
4 Sharp Prongs



RT-068-13
4 Blunt Prongs

Knapp Fine Wound Retractor
Overall Length 13.5 cm (5 1/4")



RT-074-02
2.0 mm



RT-074-05
5.0 mm



RT-074-07
7.0 mm



RT-074-10
10.0 mm

Joseph Mucus Hook
Overall Length 16.5 cm (6 1/2")



RT-120-08
8.0 mm



RT-120-10
10.0 mm



RT-120-12
12.0 mm



RT-120-14
14.0 mm

Desmarres Lid Retractor
Overall Length 16 cm (6 1/4")



Bone Rongeurs
Hohlmeißelzangen
Pinzas gubias
Pinces-gouges
Pinze-sgorbie



OR-470-19
Cottle Bone Mallet
Plain, Convex, Ø 30.0 mm,
300 Grams
Overall Length 19 cm (7 ½")

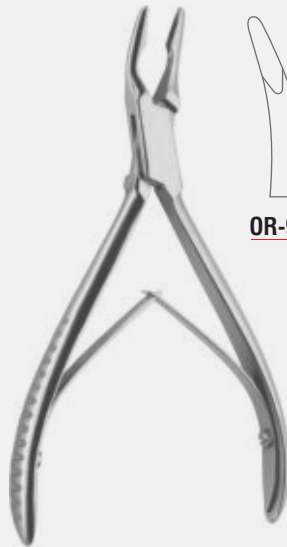

Friedman Bone Rongeur
Overall Length 13.5 cm (5 ¼")



OR-933-01



OR-934-02

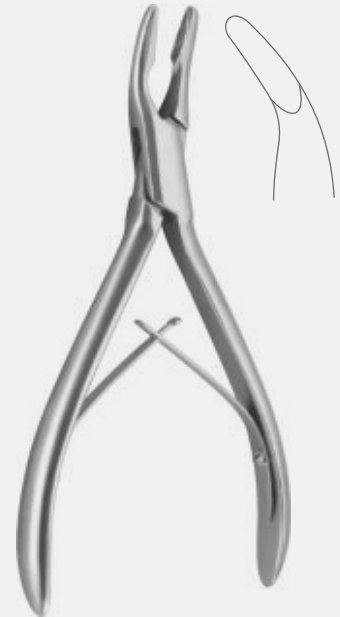

OR-937-16
Mead Bone Rongeur
Overall Length 16.5 cm (6 ½")

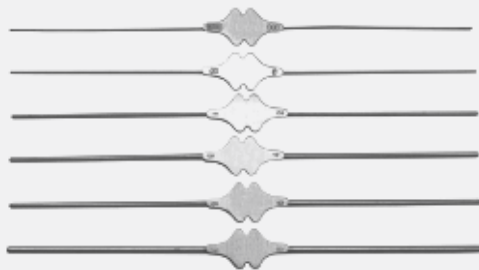

PR-200-00
Bowman Lacrimal Probes Complete
Set of 6 Probes

Sterilizing Cases
Sterilisierbehälter Koffer
Los casos de esterilización
Stérilisation cas
Sterilizzazione Custodie i

OP

OPHTHALMIC SURGERY INSTRUMENTS

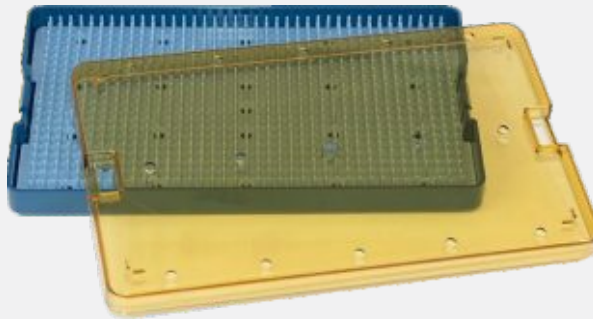

ST-110-01
Storing Case Plastic
Single Level With Perforated
Silicone Mat Size 160 x 70 x 25

ST-110-02
Storing Case Plastic
Single Level With Perforated
Silicone Mat Size 200 x 110 x 25

ST-110-03
Storing Case Plastic
Single Level With Perforated
Silicone Mat Size 265 x 160 x 25

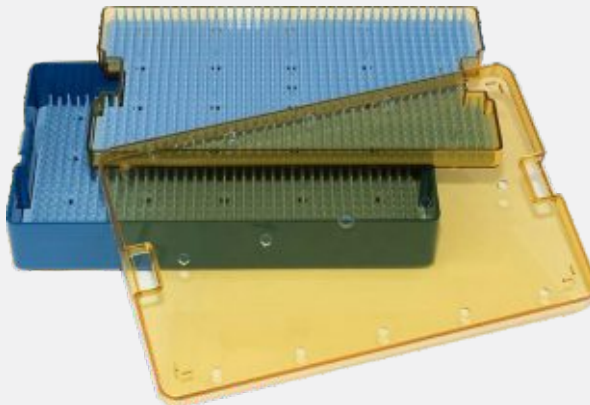

ST-112-26
Storing Case Plastic
Double Level With Perforated
Silicone Mat Size 265 x 160 x 50

Ophthalmic Surgery Sets



SURTEX
INSTRUMENTS

Crafted to Excellence

Basic Eye Surgery Set

Codes	Description	Quantity
SL-010-03	Bard-Parker Scalpel Handle No. 3 Solid 12 cm - 4 3/4"	1
SL-030-07	Scalpel Handle No. 7 Solid 16 cm - 6 1/4"	1
SL-206-13	Scalpel Handle For Micro Scalpel Blades 13 cm - 5"	1
SS-430-10	Iris Scissor Straight 10 cm - 4"	1
SS-431-10	Iris Scissor Curved 10 cm - 4"	1
AF-170-12	Micro-Mosquito Haemostatic Forcep Straight 12 cm - 4 3/4"	4
AF-171-12	Micro-Mosquito Haemostatic Forcep Curved 11.5 cm - 4 1/2"	6
AF-773-08	Backhaus Towel Clamp 9 cm - 3 1/2"	4
SS-423-09	Very Delicate Operating Scissor Curved 9 cm - 3 1/2"	1
OP-010-15	Barraquer Wire Speculum Standard Wire Blade Size 15 mm	1
OP-083-15	Lieberman Eye Speculum Adjustable Blade Size 15 mm	1
OP-091-14	Castroviejo Eye Speculum Adjustable Mechanism Blade Size 14 mm	1
OP-175-15	Desmarres Lid Retractor Thin Solid Blades - Size 2 13 cm - 5" Blade Width 15 mm	1
RT-048-02	Graefe Nerve Hook Fig. 2 14 cm - 5 1/2"	1
OP-745-50	Castroviejo Cyclodialysis Spatula 13 cm - 5" Width 0.5 mm	1
DI-850-20	Castroviejo Caliper Straight 8 cm - 3" Measuring Range 20 mm	1
FR-700-01	Graefe Eye Dressing Forcep 10 cm - 4"	1
FR-700-02	Graefe Eye Dressing Forcep 10 cm - 4"	1
FR-702-01	Graefe Dissecting Forcep 1 x 2 Teeth 10 cm - 4"	1
FR-702-02	Graefe Dissecting Forcep 1 x 2 Teeth 10 cm - 4"	1
FR-772-01	Graefe Fixation Forcep 11 cm - 4 1/4"	1
FR-750-03	Castroviejo Suture Tying Forcep 1 x 2 Teeth with Tying Platform 11 cm - 4 1/4" Tip Size 0.3 mm	1
FR-859-11	Arruga Capsule Forcep 11 cm - 4 1/4"	1
FR-918-09	Desmarres Chalazion Forcep Large - Oval Jaws 9 cm - 3 1/2" Jaw Size 20 x 13 mm	1
SS-453-11	Stevens Tenotomy Scissor Curved - Blunt/Blunt 11 cm - 4 1/2"	1
SS-653-01	Castroviejo Corneoscleral Scissor Right - Medium Blades 11 cm - 4 1/2"	1
SS-653-02	Castroviejo Corneoscleral Scissor Left - Medium Blades 11 cm - 4 1/2"	1
SS-630-12	Noyes Iris Scissor Straight - Sharp/Sharp 12.5 cm - 5"	1
SS-631-12	Noyes Iris Scissor Curved - Sharp/Sharp 12.5 cm - 5"	1
SS-683-11	Westcott Stitch Scissor Curved - Very Sharp Pointed Tips - Standard Blades 11.5 cm - 4 1/2"	1
SU-222-14	Castroviejo Micro Needle Holder Straight - Standard - With Lock 14 cm - 5 1/2"	1
OP-180-02	Scleral Shield Large (Pair) Blade Width 22 x 30 mm	2
ST-112-26	Storing Case Double Level 265 x 160 x 50 mm Plastic	1

Planned Extra-Capsular Cataract Extraction

Codes	Description	Quantity
OP-471-19	Bishop-Harmon Anterior Chamber Irrigator Gauge 19	1
AF-761-05	Jones Towel Clamp Sharp 5.5 cm - 2 1/4"	2
AF-140-10	Hartmann Haemostatic Forcep Straight 10 cm - 4"	1
AF-062-03	Dieffenbach Bulldog Clamp Straight 3.5 cm - 1 1/2"	1
OP-083-15	Lieberman Eye Speculum Adjustable Blade Size 15 mm	1
OP-010-15	Barraquer Wire Speculum Standard Wire Blade Size 15 mm	1
SL-206-13	Scalpel Handle For Micro Scalpel Blades 13 cm - 5"	2
SL-210-69 A	Micro Scalpel Blade No. 69A Pack of 25	1
OP-232-15	Disposable Stab Knife Straight 15 Degree Cutting Edge Box of 6	1
OP-320-01	Diamond Step Knife With Adjustable Cutting Depth of 0/0.3/0.4/0.5/0.6/0.8/1.0/2.5 mm Single 45° Cutting Edge 12 cm - 4 3/4" Width 1.0 mm Titanium Handle	1
OP-865-13	Fine-Thronton Swivel Fixation Ring With Swivel Handle 12 cm - 4 3/4" Tip Ø 13 mm	1
SS-651-01	Castroviejo Corneoscleral Scissor Right - Small Blades 10.5 cm - 4"	1
SS-651-02	Castroviejo Corneoscleral Scissor Left - Small Blades 10.5 cm - 4"	1
SS-675-11	Westcott Tenotomy Scissor Curved - Blunt Tips - Medium Blades 11 cm - 4 1/2"	1
SS-683-11	Westcott Stitch Scissor Curved - Very Sharp Pointed Tips - Standard Blades 11.5 cm - 4 1/2"	1
SS-695-08	Vannas Capsulotomy Scissor Curved - Sharp Tips 8 cm - 3 1/4" Blade Size 5 mm	1
SS-713-11	Stern-Gills Micro Scissor Angled Forward - Sharp Tips - Extra Thin 11 cm - 4 1/2" Blade Size 10 mm	1
DI-850-20	Castroviejo Caliper Straight 8 cm - 3" Measuring Range 20 mm	1
FR-834-12	Bonaccolto Conjunctival Forcep Longitudinal Serrated Jaws with Cross Serrations at Tips 10.5 cm - 4" Tip Width 1.2 mm Stainless Steel	1
FR-718-07	Harms-Colibri Corneal Forcep Very Delicate 1 x 2 Teeth with Tying Platform 7.5 cm - 3 1/4" Tip Size 0.12 mm	1
FR-732-10	Bonn Corneal Forcep Very Delicate 1 x 2 Teeth with Tying Platform 10 cm - 4" Tip Size 0.12 mm	1
FR-760-08	Bishop-Harmon Iris Forcep Standard 1 x 2 Teeth 8.5 cm - 3 1/4"	1
FR-780-10	McPherson Suture Tying Forcep Straight - With Tying Platform 10 cm - 4" Jaws Length 5 mm	1
FR-781-10	McPherson Suture Tying Forcep Angled - With Tying Platform 10 cm - 4" Jaws Length 5 mm	1
FR-784-10	Kelman-McPherson Suture Tying Forcep Angled - With Tying Platform 10 cm - 4" Jaws Length 7.5 mm	1
FR-801-10	Utrata Capsulorrhexis Forcep Very Delicate Triangular Grasping Tips - Extremely Thin 10.5 cm - 4" Shanks Length 11 mm	1
OP-677-11	Nagahara Nucleus Chopper And Spatula 11 cm - 4 1/4"	1
OP-826-04	Sinsky II Lens Manipulating Hook Angled 11.5 cm - 4 1/2" Tip Diameter 0.2 mm	1
OP-827-02	Kuglen Iris Hook and Lens Manipulator Push Pull Modle - Angled 11.5 cm - 4 1/2"	1
OP-635-02	Barraquer Iris Spatula Round - Smooth 12 cm - 4 3/4" Width 0.5 mm	2
SU-313-11	Barraquer Micro Needle Holder Curved - Delicate - Round Handle 11.5 cm - 4 1/2"	1
SU-213-14	Castroviejo Micro Needle Holder Curved - Delicate - With Lock 14 cm - 5 1/2"	1
OP-750-02	Lewis Lens Loop Large 14 cm - 5 1/2"	1
OP-765-10	Alfonso Nucleus Trisector For Use With Ref:- OP-775-02 10.5 cm - 4 1/4" Width 1.5 mm	1
OP-775-02	Alfonso Cutting Platform 12.5 cm - 5" Width 2 mm Stainless Steel	1
FR-869-10	Alfonso Nucleas Grasping Forcep With Two Short Rows of Delicate Interlocking Teeth 10.5 cm - 4"	1
OP-542-25	Alfonso Nucleus Irrigating Spoon 2.5 mm Wide	1
OP-542-40	Alfonso Nucleus Irrigating Spoon 4.0 mm Wide	1
OP-519-30	Gimbel Cortex Aspirating Cannula End Opening Gauge 30	1
OP-421-27	Air Injection Cannula Angled at 5 mm Gauge 27	1
OP-517-26	McIntyre Anterior Chamber Cannula Angled Gauge 26	1
OP-467-23	Jansen Capsul Polisher Cannula 23 Gauge	1
OP-451-23	Simcoe Irrigation Aspirating Cannula Original Modle Gauge 23	1
ST-112-26	Storing Case Double Level 265 x 160 x 50 mm Plastic	1

Corneal Graft Surgery Set

Codes	Description	Quantity
OP-471-19	Bishop-Harmon Anterior Chamber Irrigator Gauge 19	1
AF-761-05	Jones Towel Clamp Sharp 5.5 cm - 2 1/4"	1
OP-100-00	Flieringa Scleral Fixation Ring Set of 9 Ref:- OP-100-14 to OP-100-22	1
OP-111-16	McNeill-Goldman Scleral Fixation Ring & Blepharostat Medium, I.D Blade Size 16 mm	1
OP-010-15	Barraquer Wire Speculum Standard Wire Blade Size 15 mm	1
OP-087-15	Lieberman Eye Speculum Adjustable Blade Size 15 mm	1
AF-140-10	Hartmann Haemostatic Forcep Straight 10 cm - 4"	2
AF-062-03	Dieffenbach Bulldog Clamp Straight 3.5 cm - 1 1/2"	2
SS-659-01	Troutman-Katzin Corneal Transplant Scissor Right - Strongly Curved - Small Blades - With Lock 10.5 cm - 4"	1
SS-659-02	Troutman-Katzin Corneal Transplant Scissor Left - Strongly Curved - Small Blades - With Lock 10.5 cm - 4"	1
SS-675-11	Westcott Tenotomy Scissor Curved - Blunt Tips - Medium Blades 11 cm - 4 1/2"	1
SS-685-11	Jaffe Stitch Scissor Curved - Very Sharp Pointed Tips - Medium Blades 11 cm - 4 1/2"	1
OP-685-11	Rosen Phaco Splitter Angled 60° - Wedge Shaped 11.5 cm - 4 1/2"	1
OP-400-06	Corneal Trephine Blade Diameter 7.5 mm	1
OP-400-08	Corneal Trephine Blade Diameter 8.0 mm	1
OP-401-06	Corneal Trephine Handle Diameter 7.5 mm	1
OP-401-08	Corneal Trephine Handle Diameter 8.0 mm	1
FR-720-07	Colibri Corneal Forcep Standard 1 x 2 Teeth with Tying Platform 7.5 cm - 3 1/4" Tip Size 0.4 mm	1
FR-750-01	Castroviejo Suture Tying Forcep 1 x 2 Teeth with Tying Platform 11 cm - 4 1/4" Tip Size 0.12 mm	1
FR-750-03	Castroviejo Suture Tying Forcep 1 x 2 Teeth with Tying Platform 11 cm - 4 1/4" Tip Size 0.3 mm	1
FR-718-07	Harms-Colibri Corneal Forcep Very Delicate 1 x 2 Teeth with Tying Platform 7.5 cm - 3 1/4" Tip Size 0.12 mm	1
FR-816-10	Tennant Suture Tying Forcep Straight - Round Handle with Guide Pin - Extra Delicate Smooth Jaws 10.5 cm - 4" Jaws Length 6 mm	1
FR-817-10	Tennant Suture Tying Forcep Curved - Round Handle with Guide Pin - Extra Delicate Smooth Jaws 10.5 cm - 4" Jaws Length 6 mm	1
OP-793-14	Paton Spatula & Spoon For Corneal Button Transfer 14 cm - 5 1/2"	1
SU-323-13	Barraquer Micro Needle Holder Curved - Very Delicate - Round Handle - With Lock 13 cm - 5"	1
SU-213-14	Castroviejo Micro Needle Holder Curved - Delicate - With Lock 14 cm - 5 1/2"	1
OP-421-30	Air Injection Cannula Angled at 5 mm Gauge 30	1
OP-517-26	McIntyre Anterior Chamber Cannula Angled Gauge 26	1
ST-112-26	Storing Case Double Level 265 x 160 x 50 mm Plastic	1

Phacoemulsification Cataract Extraction Set

Codes	Description	Quantity
OP-471-19	Bishop-Harmon Anterior Chamber Irrigator Gauge 19	1
OP-083-15	Lieberman Eye Speculum Adjustable Blade Size 15 mm	2
OP-030-15	Barraquer Wire Speculum Open Blades Blade Size 15 mm	1
OP-316-03	Diamond Knife Tri-Facet Cutting Edge 12.5 cm - 5" Width 1.0 mm Titanium Handle	1
OP-341-28	Diamond Phaco Knife Angled - Spear Shaped 13 cm - 5" Blade Width 2.8 mm Titanium Handle	1
OP-230-02	Disposable Crescent Knife Angled Box of Six	1
OP-232-15	Disposable Stab Knife Straight 15 Degree Cutting Edge Box of 6	1
SL-206-13	Scalpel Handle For Micro Scalpel Blades 13 cm - 5"	1
AF-140-10	Hartmann Haemostatic Forcep Straight 10 cm - 4"	2
AF-761-05	Jones Towel Clamp Sharp 5.5 cm - 2 1/4"	2
OP-659-02	Chang Phaco Chopper Left Hand 13 cm - 5" Tip Length 0.9 mm	1
OP-532-27	Chang Hydrodissection Cannula Flat Tip With Bevelled Opening 27 Gauge	1
OP-683-11	Rosen Phaco Splitter Wedge Shaped 11.5 cm - 4 1/2"	1
OP-827-02	Kuglen Iris Hook and Lens Manipulator Push Pull Modle - Angled 11.5 cm - 4 1/2"	1
OP-689-02	Jaffe-Bechert Nucleus Rotator Blunt Forked Tip - Angled At 9 mm 11.5 cm - 4 1/2"	1
OP-729-12	Lester IOL Manipulator Angled 12 cm - 4 3/4" Tip Diameter 0.25 mm	1
SS-675-11	Westcott Tenotomy Scissor Curved - Blunt Tips - Medium Blades 11 cm - 4 1/2"	1
DI-850-20	Castroviejo Caliper Straight 8 cm - 3" Measuring Range 20 mm	1
SS-713-11	Stern-Gills Micro Scissor Angled Forward - Sharp Tips - Extra Thin 11 cm - 4 1/2" Blade Size 10 mm	1
FR-716-07	Colibri Corneal Forcep Very Delicate 1 x 2 Teeth 7.5 cm - 3 1/4" Tip Size 0.12 mm	1
FR-750-01	Castroviejo Suture Tying Forcep 1 x 2 Teeth with Tying Platform 11 cm - 4 1/4" Tip Size 0.12 mm	1
FR-724-10	Fechtner Conjunctival Forcep Very Delicate Ring Shaped Tips with Tying Platform 10.5 cm - 4"	1
FR-816-10	Tennant Suture Tying Forcep Straight - Round Handle with Guide Pin - Extra Delicate Smooth Jaws 10.5 cm - 4" Jaws Length 6 mm	1
FR-817-10	Tennant Suture Tying Forcep Curved - Round Handle with Guide Pin - Extra Delicate Smooth Jaws 10.5 cm - 4" Jaws Length 6 mm	1
FR-801-10	Utrata Capsulorrhhexis Forcep Very Delicate Triangular Grasping Tips - Extremely Thin 10.5 cm - 4" Shanks Length 11 mm	1
FR-784-10	Kelman-McPherson Suture Tying Forcep Angled - With Tying Platform 10 cm - 4" Jaws Length 7.5 mm	1
FR-885-10	Livernois-McDonald IOL Inserting Forcep Concave Jaws 10.5 cm - 4" Jaws Length 5 mm	1
FR-877-10	Livernois IOL Folding Forcep Concave Jaw Surfaces - For Soft IOLs 10.5 cm - 4"	1
SU-315-11	Barraquer Micro Needle Holder Curved - Delicate - Round Handle - With Lock 11.5 cm - 4 1/2"	1
FR-863-11	Ernest Nucleus Cracker Extra Delicate Cross Action Serrated Paddle Tips 11 cm - 4 1/4"	2
OP-451-23	Simcoe Irrigation Aspirating Cannula Original Modle Gauge 23	1
OP-475-25	Hydrodissection Cannula Angled at 8 mm - Flat Tip Gauge 25	1
OP-421-27	Air Injection Cannula Angled at 5 mm Gauge 27	1
OP-467-23	Jansen Capsul Polisher Cannula 23 Gauge	1
OP-441-19	Stevens Sub Tenon's Anesthesia Cannula Gently Curved - Flat Tip Gauge 19	1
OP-865-13	Fine-Thronton Swivel Fixation Ring With Swivel Handle 12 cm - 4 3/4" Tip Diameter 13 mm	1
OP-465-23	McIntyre Cystotome Gauge 23	1
SS-695-08	Vannas Capsulotomy Scissor Curved - Sharp Tips 8 cm - 3 1/4" Blade Size 5 mm	1
ST-112-26	Storing Case Double Level 265 x 160 x 50 mm Plastic	1

Phacostructure Cataract Extraction Set

Codes	Description	Quantity
OP-085-15	Lieberman Eye Speculum Adjustable Blade Size 15 mm	1
SS-440-11	Iris Scissor Straight 11.5 cm - 4 1/2"	1
SS-675-11	Westcott Tenotomy Scissor Curved - Blunt Tips - Medium Blades 11 cm - 4 1/2"	1
FR-750-01	Castroviejo Suture Tying Forcep 1 x 2 Teeth with Tying Platform 11 cm - 4 1/4" Tip Size 0.12 mm	1
SL-206-13	Scalpel Handle For Micro Scalpel Blades 13 cm - 5"	1
SL-210-69	A Micro Scalpel Blade No. 69A Pack of 25	1
OP-232-15	Disposable Stab Knife Straight 15 Degree Cutting Edge Box of 6	1
DI-850-20	Castroviejo Caliper Straight 8 cm - 3" Measuring Range 20 mm	1
FR-801-10	Utrata Capsulorrhexis Forcep Very Delicate Triangular Grasping Tips - Extremely Thin 10.5 cm - 4" Shanks Length 11 mm	1
OP-827-02	Kuglen Iris Hook and Lens Manipulator Push Pull Modle - Angled 11.5 cm - 4 1/2"	1
OP-775-02	Alfonso Cutting Platform 12.5 cm - 5" Width 2 mm	1
OP-775-03	Alfonso Cutting Platform 12.5 cm - 5" Width 3 mm	1
OP-765-10	Alfonso Nucleus Trisector For Use With Ref:- OP-775-02 10.5 cm - 4 1/4" Width 1.5 mm	1
OP-767-10	Bucher-Kansas Nucleus Trisector For Use With Ref:- OP-775-03 10.5 cm - 4 1/4" Width 2.5 mm	1
OP-771-11	Kansas Nucleus Bisector 11.5 cm - 4 1/2" Stainless Steel	1
FR-869-10	Alfonso Nucleus Grasping Forcep With Two Short Rows of Delicate Interlocking Teeth 10.5 cm - 4"	1
OP-542-25	Alfonso Nucleus Irrigating Spoon 2.5 mm Wide	1
OP-542-40	Alfonso Nucleus Irrigating Spoon 4.0 mm Wide	1
OP-421-27	Air Injection Cannula Angled at 5 mm Gauge 27	1
OP-525-21	Simcoe Cortex Extractor Smooth Closed Tip - 21 mm Long Gauge 21	1
FR-875-11	Dodick IOL Folding Forcep For Soft IOLs 11 cm - 4 1/4"	1
FR-889-10	Buratto Soft IOL Inserting Forcep Extra Delicate Highly Polished Convex Jaws 10 cm - 4"	1
ST-112-26	Storing Case Double Level 265 x 160 x 50 mm Plastic	1

Glaucoma (Optic Nerve Repair) Surgery Set

Codes	Description	Quantity
OP-471-19	Bishop-Harmon Anterior Chamber Irrigator Gauge 19	1
AF-761-05	Jones Towel Clamp Sharp 5.5 cm - 2 1/4"	1
AF-140-10	Hartmann Haemostatic Forcep Straight 10 cm - 4"	1
OP-064-15	Murdoch Eye Speculum Blade Size 15 mm	1
OP-010-15	Barraquer Wire Speculum Standard Wire Blade Size 15 mm	1
OP-083-15	Lieberman Eye Speculum Adjustable Blade Size 15 mm	1
SS-440-11	Iris Scissor Straight 11.5 cm - 4 1/2"	1
SS-675-11	Westcott Tenotomy Scissor Curved - Blunt Tips - Medium Blades 11 cm - 4 1/2"	1
SS-647-07	Barraquer Iris Scissor Angled 5.5 cm - 2 1/4" Blade Size 7 mm	1
SS-707-10	Gills-Vannas Micro Scissor Curved - Sharp Tips - Extra Thin 10.5 cm - 4" Blade Size 7 mm	1
SS-681-11	McPherson-Westcott Stitch Scissor Curved - Very Sharp Pointed Tips - Small Blades 11 cm - 4 1/2"	1
FR-724-10	Fechtner Conjunctival Forcep Very Delicate Ring Shaped Tips with Tying Platform 10.5 cm - 4"	2
FR-716-07	Colibri Corneal Forcep Very Delicate 1 x 2 Teeth 7.5 cm - 3 1/4" Tip Size 0.12 mm	1
FR-760-08	Bishop-Harmon Iris Forcep Standard 1 x 2 Teeth 8.5 cm - 3 1/4"	1
OP-919-09	Fechtner Trabeculectomy Marker 9 cm - 3 1/2"	1
DI-850-20	Castroviejo Caliper Straight 8 cm - 3" Measuring Range 20 mm	1
SL-206-13	Scalpel Handle For Micro Scalpel Blades 13 cm - 5"	2
OP-230-02	Disposable Crescent Knife Angled Box of Six	1
SL-210-69 A	Micro Scalpel Blade No. 69A Pack of 25	1
OP-232-15	Disposable Stab Knife Straight 15 Degree Cutting Edge Box of 6	1
OP-395-00	Luntz-Dodick Trabeculectomy Punch Complete With Punch Ref:- OP-455-01 Diameter - Deep Bite 1.0 mm - 0.5 mm	1
OP-397-00	Kelly Descemet's Membrane Punch Diameter - Deep Bite 1.0 mm - 0.5 mm	1
OP-587-13	Blumenthal Conjunctiva Dissector With Blunt Disc Shaped Tip 13 cm - 5"	1
SU-321-13	Barraquer Micro Needle Holder Curved - Very Delicate - Round Handle 13 cm - 5"	1

Glaucoma (Optic Nerve Repair) Surgery Set

Codes	Description	Quantity
OP-421-27	Air Injection Cannula Angled at 5 mm Gauge 27	1
OP-941-01	Harms Trabeculotomy Probe Right 5 cm - 2"	1
OP-941-02	Harms Trabeculotomy Probe Left 5 cm - 2"	1
ST-112-26	Storing Case Double Level 265 x 160 x 50 mm Plastic	1

LASIK Set

Codes	Description	Quantity
OP-083-15	Lieberman Eye Speculum Adjustable Blade Size 15 mm	1
OP-083-15 A	Lieberman Eye Speculum With Aspirating Ports Adjustable Blade Size 15 mm	1
OP-591-12	Buratto Lasik Flap Protector 12.5 cm - 5"	1
OP-597-11	Mannis-Buratto Lasik Flap Protector Blades Angled 45° 11.5 cm - 4 1/2"	1
OP-713-14	Hersh Flap Spatula 14 cm - 5 1/2"	1
OP-717-12	Fukasaaku Lasik Spatula 12 cm - 4 3/4"	1
OP-720-13	Katzen Lasik Flap Unzipper 13.5 cm - 5 1/4"	1
OP-863-11	Gimbel Stabilization Ring With Swivel Handle 11.5 cm - 4 1/2" Tip Diameter 13 mm	1
OP-887-11	Chayet Corneal Marker for LASIK Surgery 11.5 cm - 4 1/2"	1
FR-793-10	Buratto LASIK Flap Forcep Curved - Disc Shaped Serrated Jaws 10.5 cm - 4"	1
OP-507-25	Banaji Lasik Cannula With 6 Ports Gauge 25	1
OP-495-26	Spatulated Lasik Cannula Flattened Spatulated Tip - End Opening Gauge 26	1
OP-509-23	Buratto Lasik Cannula With 3 Ports - Slightly Flattened Gauge 23	1
ST-110-03	Storing Case Large 265 x 160 x 25 mm Plastic	1

LASEK Surgery Set

Codes	Description	Quantity
OP-083-15 A	Lieberman Eye Speculum With Aspirating Ports Adjustable Blade Size 15 mm	1
OP-385-08	Camellin Lasek Trepine & Alcohol Retaining Well 12.5 cm - 5" Diameter 8 mm - 8.5 mm	1
OP-385-09	Camellin Lasek Trepine & Alcohol Retaining Well 12.5 cm - 5" Diameter 9 mm - 9.5 mm	1
OP-619-13	Sloane Lasek Micro Hoe & Epi Peeler 13.5 cm - 5 1/4"	1
OP-627-12	Sloane Lasek Flap Repositor Gently Curved Spatulated Tip 12 cm - 4 3/4"	1
OP-439-25	Lasek Alcohol Cannula Delicate Olive Shaped Tip Gauge 25	1
ST-110-03	Storing Case Small 165 x 70 x 25 mm Plastic	1

Chalazion Surgery Set

Codes	Description	Quantity
OP-192-11	Jaeger Lid Plate 11 cm - 4 1/4"	1
OP-550-01	Meyerhoefer Chalazion Curette Size 1 12.5 cm - 5" Diameter 1.75 mm	1
OP-550-02	Meyerhoefer Chalazion Curette Size 2 12.5 cm - 5" Diameter 2.25 mm	1
OP-550-03	Meyerhoefer Chalazion Curette Size 3 12.5 cm - 5" Diameter 2.5 mm	1
OP-550-04	Meyerhoefer Chalazion Curette Size 4 12.5 cm - 5" Diameter 3.5 mm	1
SS-441-11	Iris Scissor Curved 11.5 cm - 4 1/2"	1
FR-768-09	Manhattan Eye and Ear Fixation Forcep 1 x 2 Teeth with Tying Platform 9 cm - 3 1/2" Tip Size 0.3 mm	1
FR-912-12	Hunt Chalazion Forcep Round Jaws 9.5 cm - 3 3/4" Jaw Diameter 12 mm Ø	1
FR-916-09	Francis Chalazion Forcep Medium - Oval Jaws 9.5 cm - 3 3/4" Jaw Size 14 x 11 mm	1
SU-211-14	Castroviejo Micro Needle Holder Curved - Delicate 14 cm - 5 1/2"	1
SL-206-13	Scalpel Handle For Micro Scalpel Blades 13 cm - 5"	1
SL-210-67	Micro Scalpel Blade No. 67 Pack of 25	1
ST-110-03	Storing Case Large 265 x 160 x 25 mm Plastic	1

Strabismus / Squint Surgery Set

Codes	Description	Quantity
OP-087-10	Lieberman Eye Speculum Adjustable - Solid Blades Blade Size 10 mm	1
OP-087-15	Lieberman Eye Speculum Adjustable Blade Size 15 mm	1
AF-141-10	Hartmann Haemostatic Forcep Curved 9.5 cm - 3 3/4"	2
AF-062-03	Dieffenbach Bulldog Clamp Straight 3.5 cm - 1 1/2"	2
OP-211-07	Helveston Tissue Retractor Thin Curved Blade 12.5 cm - 5" Blade Width 7 mm	1
OP-211-09	Helveston Tissue Retractor Thin Curved Blade 12.5 cm - 5" Blade Width 9 mm	1
OP-211-11	Helveston Tissue Retractor Thin Curved Blade 6.5 cm - 2 1/2" Blade Width 11 mm	2
OP-873-12	Helveston Teaser Hook Extra Delicate - Blunt 12.5 cm - 5"	2
OP-877-01	Helveston Finder Hook Large 12.5 cm - 5"	1
OP-877-02	Helveston Finder Hook Small 12 cm - 4 3/4"	1
OP-879-01	Helveston Muscle Hook Fig. 1 13 cm - 5" Tip Length 8 mm	1
OP-879-02	Helveston Muscle Hook Fig. 2 13 cm - 5" Tip Length 10 mm	1
OP-879-03	Helveston Muscle Hook Fig. 3 13 cm - 5" Tip Length 12 mm	1
OP-930-12	Helveston Scleral Ruler 15 mm Long in Notches in 5 mm increments 12 cm - 4 3/4"	1
DI-850-20	Castroviejo Caliper Straight 8 cm - 3" Measuring Range 20 mm	1
SS-675-11	Westcott Tenotomy Scissor Curved - Blunt Tips - Medium Blades 11 cm - 4 1/2"	1
SS-683-11	Westcott Stitch Scissor Curved - Very Sharp Pointed Tips - Standard Blades 11.5 cm - 4 1/2"	1
FR-732-10	Bonn Corneal Forcep Very Delicate 1 x 2 Teeth with Tying Platform 10 cm - 4" Tip Size 0.12 mm	1
FR-777-01	Moody Fixation Forcep Curved Right 11 cm - 4 1/4"	1
FR-777-02	Moody Fixation Forcep Curved Left 11 cm - 4 1/4"	1
FR-776-02	Lester Fixation Forcep Angled - 2 x 3 Teeth 9.5 cm - 3 3/4"	3
FR-824-10	Helveston Suture Tying Forcep Straight 10.5 cm - 4"	1
OP-881-02	Jameson Muscle Hook Large 13.5 cm - 5 1/4"	1
SU-222-14	Castroviejo Micro Needle Holder Straight - Standard - With Lock 14 cm - 5 1/2"	1
SU-323-13	Barraquer Micro Needle Holder Curved - Very Delicate - Round Handle - With Lock 13 cm - 5"	1
OP-471-19	Bishop-Harmon Anterior Chamber Irrigator Gauge 19	1
SL-206-13	Scalpel Handle For Micro Scalpel Blades 13 cm - 5"	1
SL-210-69	Micro Scalpel Blade No. 69 Pack of 25	1
ST-112-26	Storing Case Double Level 265 x 160 x 50 mm Plastic	1

Lacrimal (Dacryocystorhinostomy) Surgery Set

Codes	Description	Quantity
OP-471-19	Bishop-Harmon Anterior Chamber Irrigator Gauge 19	1
AF-773-08	Backhaus Towel Clamp 9 cm - 3 1/2"	2
AF-160-12	Halsted-Mosquito Haemostatic Forcep Straight 12.5 cm - 5"	2
AF-161-12	Halsted-Mosquito Haemostatic Forcep Curved 12 cm - 4 3/4"	2
RH-305-03	Kerrison Sphenoid Punch Up Cutting 14 cm - 5 1/2" Bite size 3.0 x 3.0 mm	1
RH-033-03	Hartmann-Halle Nasal Speculum Fig. 3 15.5 cm - 6" Blade Length 35 mm	1
OR-937-16	Mead Bone Rongeur 16.5 cm - 6 1/2"	1
OR-470-19	Cottle Bone Mallet Plain - Convex 19 cm - 7 1/2" Head Ø 30.0 mm - Weight 300 Grams	1
SL-206-13	Scalpel Handle For Micro Scalpel Blades 13 cm - 5"	1
SL-210-65	Micro Scalpel Blade No. 65 Pack of 25	1
OP-220-00	Stevenson Lacrimal Sac Retractor 3 x 3 Blunt Pronges - Adjustable	1
OP-410-23	Lacrimal Cannula Straight Gauge 23	1
OP-411-23	Lacrimal Cannula Curved Gauge 23	1
OP-950-14	Castroviejo Lacrimal Dilator Double Ended Fine and Meadium Taper 14 cm - 5 1/2"	1
RH-475-18	Freer Septum Elevator Double Ended - Sharp/Blunt 18.5 cm - 7 1/4" Blade Size 1 - Blade Size 2 5.0 mm - 5.0 mm	1
RH-604-16	West Septum Chisel 16 cm - 6 1/4"	1
RH-601-16	Freer Septum Chisel Curved 16 cm - 6 1/4" Blade Width 4.0 mm	1
OP-954-14	Worst Pigtail Probe With Hook 16 cm - 6 1/4"	1
OP-956-14	Crawford Retrieval Hook 14.5 cm - 5 3/4"	1
OP-960-00	Crawford Lacrimal Intubation Set Including 30.5 cm - 12" Silicone Tube and Two Olive Tip Probes Ø 0.6 mm	1
PR-200-00	Bowman Probes Complete Set of 7	1
FR-846-10	Gold Punctal Plug Forcep With Longitudinal Groove - Pointed Tips 11 cm - 4 1/4"	1
FR-700-01	Graefe Eye Dressing Forcep 10 cm - 4"	1
FR-766-09	Sauer Fixation Forcep 1 x 2 Teeth 9 cm - 3 1/2" Tip Size 0.3 mm	1
FR-834-12	Bonaccolto Conjunctival Forcep Longitudinal Serrated Jaws with Cross Serrations at Tips 10.5 cm - 4" Tip Width 1.2 mm	1
FR-750-03	Castroviejo Suture Tying Forcep 1 x 2 Teeth with Tying Platform 11 cm - 4 1/4" Tip Size 0.3 mm	1
RT-068-13	Knapp Fine Wound Retractor 4 Blunt Prongs 13.5 cm - 5 1/4"	1
SS-453-11	Stevens Tenotomy Scissor Curved - Blunt/Blunt 11 cm - 4 1/2"	1
SS-440-11	Iris Scissor Straight 11.5 cm - 4 1/2"	1
SU-213-14	Castroviejo Micro Needle Holder Curved - Delicate - With Lock 14 cm - 5 1/2"	1
SS-683-11	Westcott Stitch Scissor Curved - Very Sharp Pointed Tips - Standard Blades 11.5 cm - 4 1/2"	1
SS-679-11	Tibolt Punctal Scissor One Conically Shaped Blade with Micro Grooves and Textured Surface 11.5 cm - 4 1/2"	1
ST-112-26	Storing Case Double Level 265 x 160 x 50 mm Plastic	1

Enucleation / Evisceration Set

Codes	Description	Quantity
OP-078-00	Lester-Burch Eye Speculum Adjustable	1
AF-161-12	Halsted-Mosquito Haemostatic Forcep Curved 12 cm - 4 3/4"	1
OP-802-15	Wells Enucleation Spoon 15 cm - 6"	1
SS-469-11	Enucleation Scissor Curved 11.5 cm - 4 1/2"	1
OP-800-01	Bunge Evisceration Spoon Small 13.5 cm - 5 1/4"	1
OP-800-02	Bunge Evisceration Spoon Small 14 cm - 5 1/2"	1
RT-048-02	Graefe Nerve Hook Fig. 2 14 cm - 5 1/2"	1
SS-452-11	Stevens Tenotomy Scissor Straight - Blunt/Blunt 11 cm - 4 1/2"	1
FR-702-01	Graefe Dissecting Forcep 1 x 2 Teeth 10 cm - 4"	1
AF-161-12	Halsted-Mosquito Haemostatic Forcep Curved 12 cm - 4 3/4"	1
ST-110-03	Storing Case Large 265 x 160 x 25 mm Plastic	1

Pterygium Excision Set

Codes	Description	Quantity
SL-206-13	Scalpel Handle For Micro Scalpel Blades 13 cm - 5"	1
SL-210-64	Micro Scalpel Blade No. 64 Pack of 25	1
OP-076-16	Lancaster Eye Speculum Adjustable Blade Size 16 mm	1
FR-780-10	McPherson Suture Tying Forcep Straight - With Tying Platform 10 cm - 4" Jaws Length 5 mm	1
FR-750-01	Castroviejo Suture Tying Forcep 1 x 2 Teeth with Tying Platform 11 cm - 4 1/4" Tip Size 0.12 mm	1
OP-260-12	Gill Corneal Knife Curved Cutting Edge - Straight 12.5 cm - 5"	1
SU-211-14	Castroviejo Micro Needle Holder Curved - Delicate 14 cm - 5 1/2"	1
SS-440-11	Iris Scissor Straight 11.5 cm - 4 1/2"	1
SS-430-10	Iris Scissor Straight 10 cm - 4"	1
FR-834-12	Bonaccolto Conjunctival Forcep Longitudinal Serrated Jaws with Cross Serrations at Tips 10.5 cm - 4" Tip Width 1.2 mm	1
FR-776-02	Lester Fixation Forcep Angled - 2 x 3 Teeth 9.5 cm - 3 3/4"	1
ST-110-03	Storing Case Large 265 x 160 x 25 mm Plastic	1

Scleral Buckling (Retinal Detachment) Set

Codes	Description	Quantity
OP-010-15	Barraquer Wire Speculum Standard Wire Blade Size 15 mm	1
DI-850-20	Castroviejo Caliper Straight 8 cm - 3" Measuring Range 20 mm	1
OP-160-14	Schocket Scleral Depressor Double End With Pocket Clip 14 cm - 5 1/2"	1
FR-760-08	Bishop-Harmon Iris Forcep Standard 1 x 2 Teeth 8.5 cm - 3 1/4"	1
FR-750-01	Castroviejo Suture Tying Forcep 1 x 2 Teeth with Tying Platform 11 cm - 4 1/4" Tip Size 0.12 mm	1
FR-700-01	Graefe Eye Dressing Forcep 10 cm - 4"	1
FR-781-10	McPherson Suture Tying Forcep Angled - With Tying Platform 10 cm - 4" Jaws Length 5 mm	1
FR-716-07	Colibri Corneal Forcep Very Delicate 1 x 2 Teeth 7.5 cm - 3 1/4" Tip Size 0.12 mm	1
OP-881-01	Jameson Muscle Hook Small 13 cm - 5"	1
SU-333-14	Barraquer Micro Needle Holder Curved - Very Delicate - Round Handle - With Lock 14 cm - 5 1/2"	1
SU-222-14	Castroviejo Micro Needle Holder Straight - Standard - With Lock 14 cm - 5 1/2"	1
DI-880-15	Ruler Graduated in mm and inches 16.5 cm - 6 1/2" Measuring Range 150 mm	1
SS-441-11	Iris Scissor Curved 11.5 cm - 4 1/2"	1
SS-453-11	Stevens Tenotomy Scissor Curved - Blunt/Blunt 11 cm - 4 1/2"	1
SS-683-11	Westcott Stitch Scissor Curved - Very Sharp Pointed Tips - Standard Blades 11.5 cm - 4 1/2"	1
AF-062-03	Dieffenbach Bulldog Clamp Straight 3.5 cm - 1 1/2"	2
OP-750-01	Lewis Lens Loop Small 13 cm - 5"	1
FR-750-03	Castroviejo Suture Tying Forcep 1 x 2 Teeth with Tying Platform 11 cm - 4 1/4" Tip Size 0.3 mm	1
FR-750-05	Castroviejo Suture Tying Forcep 1 x 2 Teeth with Tying Platform 11 cm - 4 1/4" Tip Size 0.5 mm	1
AF-160-12	Halsted-Mosquito Haemostatic Forcep Straight 12.5 cm - 5"	2
FR-903-01	Jameson Muscle Forcep Right - With Slide Lock 6 Teeth - Adult Size 10 cm - 4"	1
FR-903-02	Jameson Muscle Forcep Left - With Slide Lock 6 Teeth - Adult Size 10 cm - 4"	1
FR-784-10	Kelman-McPherson Suture Tying Forcep Angled - With Tying Platform 10 cm - 4" Jaws Length 7.5 mm	1
FR-702-01	Graefe Dissecting Forcep 1 x 2 Teeth 10 cm - 4"	1
FR-840-10	Nugent Utility Forcep Smooth Jaws 10.5 cm - 4"	1
AF-755-09	Schaedel Towel Clamp Sharp 9 cm - 3 1/2"	2
OP-875-13	Gass Retinal Detachment Hook With Oval Hole 13 cm - 5"	1
OP-883-13	Green Muscle Hook 13 cm - 5"	1
OP-849-01	Twist Hook Right 11 cm - 4 1/4"	1
SU-333-14	Barraquer Micro Needle Holder Curved - Very Delicate - Round Handle - With Lock 14 cm - 5 1/2"	1
OP-171-15	Schepens Orbital Retractor 15 cm - 6"	1
SS-643-11	Wecker Iris Scissor Angled - Sharp/Blunt 11 cm - 4 1/2"	1
SS-440-11	Iris Scissor Straight 11.5 cm - 4 1/2"	1
OP-230-02	Disposable Crescent Knife Angled Box of 6	1
OP-232-15	Disposable Stab Knife Straight 15 Degree Cutting Edge Box of 6	1
ST-112-26	Storing Case Double Level 265 x 160 x 50 mm Plastic	1

Blepharoplasty Set (Eyelid Surgery Set)

Codes	Description	Quantity
DI-880-15	Ruler Graduated in mm and inches 16.5 cm - 6 1/2" Measuring Range 150 mm	1
SL-012-03	Scalpel Handle No. 3 Solid, cm-Graduation 12 cm - 4 3/4"	1
SS-440-11 SC	SuperEdge™ Iris Scissor Straight 11.5 cm - 4 1/2"	1
SS-441-11 SC	SuperEdge™ Iris Scissor Curved 11.5 cm - 4 1/2"	1
AF-160-12	Halsted-Mosquito Haemostatic Forcep Straight 12.5 cm - 5"	2
AF-161-12	Halsted-Mosquito Haemostatic Forcep Curved 12 cm - 4 3/4"	2
SU-222-14	Castroviejo Micro Needle Holder Straight - Standard - With Lock 14 cm - 5 1/2"	2
SS-243-12	Kilner Dissecting Scissor Curved 12 cm - 4 3/4"	1
RT-074-02	Joseph Mucosa Hook 16.5 cm - 6 1/2" Width 2.0 mm	2
AF-773-08	Backhaus Towel Clamp 9 cm - 3 1/2"	4
FR-250-12	Adson Dissecting Forcep 1 x 2 Teeth 12 cm - 4 3/4"	1
RT-120-14	Desmarres Lid Retractor 16 cm - 6 1/4" Blade Width 14.0 mm	1
DI-850-20	Castroviejo Caliper Straight 8 cm - 3" Measuring Range 20 mm	1
FR-760-08	Bishop-Harmon Iris Forcep Standard 1 x 2 Teeth 8.5 cm - 3 1/4"	1
ST-110-02	Storing Case Medium 200 x 110 x 25 mm Plastic	1

Ocuplasty Set (Eyelid Surgery Set)

Codes	Description	Quantity
OP-078-00	Lester-Burch Eye Speculum Adjustable	1
OP-171-15	Schepens Orbital Retractor 15 cm - 6"	1
OP-175-15	Desmarres Lid Retractor Thin Solid Blades - Size 2 13 cm - 5" Blade Width 15 mm	1
OP-180-02	Scleral Shield Large (Pair) Blade Width 22 x 30 mm	1
OP-192-11	Jaeger Lid Plate 11 cm - 4 1/4"	1
OP-197-14	Wright Fascia Needle Oval Hole 14 cm - 5 1/2" Width - Length 1 x 6 mm	1
RT-068-13	Knapp Fine Wound Retractor 4 Blunt Prongs 13.5 cm - 5 1/4"	1
OP-550-03	Meyerhoefer Chalazion Curette Size 3 12.5 cm - 5" Diameter 2.5 mm	1
OP-800-02	Bunge Evisceration Spoon Small 14 cm - 5 1/2"	1
OP-845-02	Fixation Hook Large (Sharp) 13 cm - 5"	1
RT-048-02	Graefe Nerve Hook Fig. 2 14 cm - 5 1/2"	1
DI-880-15	Ruler Graduated in mm and inches 16.5 cm - 6 1/2" Measuring Range 150 mm	1
SS-452-11	Stevens Tenotomy Scissor Straight - Blunt/Blunt 11 cm - 4 1/2"	1
SS-469-11	Enucleation Scissor Curved 11.5 cm - 4 1/2"	1
FR-702-01	Graefe Dissecting Forcep 1 x 2 Teeth 10 cm - 4"	1
FR-906-10	Putterman Mullers Muscle Conjunctival Resection Ptosis Clamp - With Side Lock 10.5 cm - 4"	1
FR-916-09	Francis Chalazion Forcep Medium - Oval Jaws 9.5 cm - 3 3/4" Jaw Size 14 x 11 mm	1
FR-910-09	Downes Lid Clamp 9.5 cm - 3 3/4"	1
AF-140-10	Hartmann Haemostatic Forcep Straight 10 cm - 4"	1
SU-222-14	Castroviejo Micro Needle Holder Straight - Standard - With Lock 14 cm - 5 1/2"	1
RH-475-18	Freer Septum Elevator Double Ended - Sharp/Blunt 18.5 cm - 7 1/4" Blade Size 1 - Blade Size 2 5.0 mm - 5.0 mm	1
RH-604-16	West Septum Chisel 16 cm - 6 1/4"	1
OP-948-02	Wilder Lacrimal Dilator Medium Taper - Size 2 10.5 cm - 4 1/4"	1
PR-204-34	Bowman Probe Fig. 3/4 13 cm - 5" Tip Diameter 1.3 mm - 1.4 mm	1
OP-954-14	Worst Pigtail Probe With Hook 16 cm - 6 1/4"	1
SL-012-03	Scalpel Handle No. 3 Solid, cm-Graduation 12 cm - 4 3/4"	1
SL-100-11	Scalpel Blade No. 11 Pack of 100	1
SL-100-13	Scalpel Blade No. 15 Pack of 100	1
ST-112-26	Storing Case Double Level 265 x 160 x 50 mm Plastic	1

23 G Vitreoretinal Set

Codes	Description	Quantity
OP-091-16	Castroviejo Eye Speculum Adjustable Mechanism Blade Size 16 mm	1
AF-062-03	Dieffenbach Bulldog Clamp Straight 3.5 cm - 1 1/2"	4
AF-160-12	Halsted-Mosquito Haemostatic Forcep Straight 12.5 cm - 5"	2
SS-440-11	Iris Scissor Straight 11.5 cm - 4 1/2"	1
OP-471-19	Bishop-Harmon Anterior Chamber Irrigator Gauge 19	1
SS-452-11	Stevens Tenotomy Scissor Straight - Blunt/Blunt 11 cm - 4 1/2"	1
SS-453-11	Stevens Tenotomy Scissor Curved - Blunt/Blunt 11 cm - 4 1/2"	1
SS-675-11	Westcott Tenotomy Scissor Curved - Blunt Tips - Medium Blades 11 cm - 4 1/2"	1
SS-683-11	Westcott Stitch Scissor Curved - Very Sharp Pointed Tips - Standard Blades 11.5 cm - 4 1/2"	1
SL-206-13	Scalpel Handle For Micro Scalpel Blades 13 cm - 5"	1
SL-210-64	Micro Scalpel Blade No. 64 Pack of 25	1
OP-234-19	Disposable MVR Knife Straight 19 Ga Box of 6	1
OP-171-15	Schepens Orbital Retractor 15 cm - 6"	1
RT-048-02	Graefe Nerve Hook Fig. 2 14 cm - 5 1/2"	1
OP-875-13	Gass Retinal Detachment Hook With Oval Hole 13 cm - 5"	1
OP-160-14	Schocket Scleral Depressor Double End With Pocket Clip 14 cm - 5 1/2"	1
DI-850-20	Castroviejo Caliper Straight 8 cm - 3" Measuring Range 20 mm	1
OP-151-01	Gass Scleral Marker Tip Diameter 1.5 mm	1
FR-907-11	Watzke Sleeve Spreading Forcep 11.5 cm - 4 1/2" Jaws Length 10 mm	1
FR-834-12	Bonaccolto Conjunctival Forcep Longitudinal Serrated Jaws with Cross Serrations at Tips 10.5 cm - 4" Tip Width 1.2 mm	1
FR-840-10	Nugent Utility Forcep Smooth Jaws 10.5 cm - 4"	1
FR-750-01	Castroviejo Suture Tying Forcep 1 x 2 Teeth with Tying Platform 11 cm - 4 1/4" Tip Size 0.12 mm	1
FR-750-03	Castroviejo Suture Tying Forcep 1 x 2 Teeth with Tying Platform 11 cm - 4 1/4" Tip Size 0.3 mm	1
FR-760-08	Bishop-Harmon Iris Forcep Standard 1 x 2 Teeth 8.5 cm - 3 1/4"	2
SU-213-14	Castroviejo Micro Needle Holder Curved - Delicate - With Lock 14 cm - 5 1/2"	1
SU-212-14	Castroviejo Micro Needle Holder Straight - Delicate - With Lock 14 cm - 5 1/2"	1
FR-780-10	McPherson Suture Tying Forcep Straight - With Tying Platform 10 cm - 4" Jaws Length 5 mm	1
OP-211-07	Helveston Tissue Retractor Thin Curved Blade 12.5 cm - 5" Blade Width 7 mm	1
OP-211-09	Helveston Tissue Retractor Thin Curved Blade 12.5 cm - 5" Blade Width 9 mm	1
OP-429-22	Viscoelastic Aspirating Cannula Angled at 10 mm Gauge 22	1
OP-427-19	Randolph Cyclodialysis Cannula Flat Tip Gauge 19	1
OP-934-35	Braunstein Caliper 3.5 / 4.0 mm	1
SS-721-23	Virectomy Scissor Curved - Horizontal Opening 23 G	1
FR-680-23	Virectomy Forcep Straight Horizontal Opening - Serrated Tips 23 G	1
FR-682-23	Virectomy Forcep Straight End Gripping Jaws Horizontal Opening Tips 23 G	1
FR-689-23	Virectomy Forcep Straight Asymmetrical Jaws 23 G	1
FR-690-23	ILM Virectomy Forcep Straight 23 G	1
ST-112-26	Storing Case Double Level 265 x 160 x 50 mm Plastic	1

Micro Incision Cataract Surgery (MICS) Surgery Set

Codes	Description	Quantity
OP-357-18	MICS Diamond Knife Angled Trapezoid Cutting Edge 12 cm - 4 3/4" Blade Width 1.8 to 2.2 mm Titanium Handle	1
OP-735-12	Alio-Kelman IOL Hook 12 cm - 4 3/4" Tip Diameter 0.2 mm	1
SS-725-23	Alio MICS Virectomy Scissor Straight Horizontal Opening With Curved Shaft 23 G	1
FR-695-23	Alio MICS Virectomy Capsulorrhexis Forcep Angled Shaft 23 G	1
FR-807-11	Inamura Capsulorrhexis Forcep Delicate Tapered Shanks 11.5 cm - 4 1/2" Shanks Length 12 mm	1
FR-863-11	Ernest Nucleus Cracker Extra Delicate Cross Action Serrated Paddle Tips 11 cm - 4 1/4"	1
OP-549-01 T	Irrigation Handpiece For Bimanual Technique 2 x 0.5 mm (21G) Side Ports 10.5 cm - 4" Titanium	1
OP-549-02 T	Aspiration Handpiece For Bimanual Technique 2 x 0.5 mm (21G) Side Ports 10.5 cm - 4" Titanium	1
ST-110-02	Storing Case Medium 200 x 110 x 25 mm Plastic	1

Deep Anterior Lamellar Keratoplasty (DALK) Set

Codes	Description	Quantity
OP-083-15	Lieberman Eye Speculum Adjustable Blade Size 15 mm	1
OP-629-01	DALK Corneal Dissector 12 mm Long Flat Vaulted Spatula With Vaulted Tip 12.5 cm - 5"	1
OP-629-02	Rosenwasser DALK Trisector 10 mm Long Triangular Shaft With Spatula Shaped Tip 12.5 cm - 5"	1
OP-629-03	Bonfadini DALK Spatula Vaulted 1.0 mm Wide 8 mm Spatula Shaped Blade With Central Groove 12.5 cm - 5"	1
SS-649-01	Holland DALK Scissor With Inner Spatulated Blade Curved Right 10.5 cm - 4"	1
SS-649-02	Holland DALK Scissor With Inner Spatulated Blade Curved Left 10.5 cm - 4"	1
SS-705-08	Holland DALK Scissor Angled Blade With Blunt Tips 8 cm - 3 1/4"	1
OP-417-27	DALK Air Injection Cannula Vaulted Shank With Flattened Tip Gauge 27	1
OP-419-27	Rosenwasser DALK Air Injection Cannula Flattened Cobra Shaped Tip Gauge 27	1
FR-816-10	Tennant Suture Tying Forcep Straight - Round Handle with Guide Pin - Extra Delicate Smooth Jaws 10.5 cm - 4" Jaws Length 6 mm	1
FR-817-10	Tennant Suture Tying Forcep Curved - Round Handle with Guide Pin - Extra Delicate Smooth Jaws 10.5 cm - 4" Jaws Length 6 mm	1
SU-313-11	Barraquer Micro Needle Holder Curved - Delicate - Round Handle 11.5 cm - 4 1/2"	1

TERMS & CONDITIONS

1. Definitions

Company means Surtex Instruments Ltd (registered in the United Kingdom under registration number 7035724).

Customer means the company, firm or organization who's Order for the Goods is accepted by the Company.

Contract means the Order accepted by the Company and incorporating these conditions.

Goods means the goods which the Company agrees to supply in accordance with these conditions and which are identified on the Order.

Order means the order for the purchase of the Goods submitted by the Customer.

- i. Any reference to a law is a reference to it as in force for the time being taking account of any amendment, extension, application or re-enactment and includes any subordinate legislation for the time being in force made under it.
- ii. Where a condition provides for a list of items following the word "including" or "includes", then such list is not to be interpreted as being an exhaustive list.

2. Incorporation of Conditions

- i. These conditions shall apply to the Contract to the exclusion of all other terms and conditions, including any terms and conditions which the Customer may purport to apply under any order (including the Order), confirmation of order or similar document or in any correspondence.
- ii. No variation to these conditions shall be binding unless agreed in writing by an authorized representative of the Company.
- iii. The Contract constitutes the entire understanding between the Company and the Customer with respect to the Goods and supersedes all previous agreements and understandings between the parties. The Customer acknowledges that it has not relied upon any statement made orally or in writing by the Company, its employees or agents to the Customer, which are not expressly incorporated into the contract.

3. Ordering

- i. Each order (whether submitted by telephone, fax, post, email or electronic ordering system) shall be deemed to be an offer by the Customer to purchase the Goods pursuant to these conditions. The Company may, at its complete discretion, refuse to accept any Order.
- ii. The Customer shall be responsible to the Company for ensuring the accuracy of the terms of any Order (including the description of the Goods ordered).

Samples and Free of Charge Goods

- iii. For the avoidance of doubt, where no order is placed and the Company provides Samples, to familiarize the Customer with the goods, as part of a sampling program or where the Company provides Free of Charge Goods to the Customer as part of a clinical trial or compassionate use program these conditions shall, to the extent applicable, apply to such Samples and Free of Charge Goods.

4. Price and Payments

- i. Subject to the condition 4.5, unless and otherwise agreed by the Company in writing, the price of the Goods shall be the price listed in the Company's published price list current at the date of the Company's acceptance of the Order. Subject to the condition 4.4, any price may be altered from time to time by the Company on giving not less than thirty days notice to the Customer.
- ii. Standard delivery shall be in accordance with the condition 6.1 or as stated on the Pro Forma offer whichever is greater. If the Customer requires delivery within an alternative time period, the Customer shall contact the Company's customer Support Centre to agree an alternative time period, which will be charged at an additional cost to the Customer. All delivery times are subject to the Goods being in stock at the time of the Company's acceptance of the Order.
- iii. The price is exclusive of VAT and all other applicable taxes and duties, which the Customer shall be additionally liable to pay the Company.
- iv. The Company reserves the right, by giving notice to the Customer at any time before delivery, to increase the price of the Goods to reflect any increase in the cost of the Company which is due to any factor beyond the reasonable control of the Company.
- v. The Customer shall pay the price within ten days of the date of the Company's invoice (the "Due Date"). In the case of payment other than by cash, payment shall only be deemed to have been made on receipt of cleared funds. The time of payment of the price shall be of the essence.
- vi. If the Customer fails to make payment on the due date then the Company shall be entitled to charge the Customer interest (both before and after judgment) on the amount unpaid, in accordance with the Late Payment of Commercial Debts (Interest) Act 1998.
- vii. The Customer shall not in any circumstances or for any reason whatsoever be entitled to make any deduction or withhold any sum from the price by way of set-off or otherwise.
- viii. All payments payable to the Company under the Contract shall become due immediately on its termination, despite any other provision.

5. The Goods

- i. The quantity and description of the Goods shall be as set out in the Order.
- ii. The Goods shall be supplied in accordance with the description in the Order. The Company may from time to time make changes to the specification(s) of the Goods, which are required to comply with any applicable safety or statutory requirements or which do not materially affect the quality or fitness for purpose of the Goods.
- iii. The specifications and designs of the Goods (including the copyright, design right and other intellectual property in them) shall as between the parties be and remain the property of the Company.
- iv. The Customer undertakes not to use any trademarks or trade names applied by the Company to the Goods, nor do or permit anything to be done where by the good will or reputation of such trademarks or trade names may be prejudiced or damaged.
- v. All samples must be clearly identified as such, and the Customer must not sell any Samples to any third party.

6. Delivery

- i. Subject to the conditions 4.2 and 6.2, delivery of the Goods shall be made to the delivery address specified in the Order normally within 30 days or as stated on the Pro Forma Invoice whichever is greater after the date of the Company's acceptance of the Order.

- ii. The Company reserves the right to withhold delivery of any Goods if any sum due to the Company under any contract with the Customer is overdue or if, in the reasonable opinion of the Company, the financial standing of the customer has been impaired for any other reason.
- iii. Time of delivery shall not be of the essence and, subject to condition 8.6; the Company shall not be liable for any loss or damage whatever due to any failure by the Company to deliver the Goods (or any of them) promptly or at all.
- iv. The Company may deliver the Goods by separate installments. Each separate installment shall be invoiced and paid for in accordance with the provisions of the Contract. Each installment shall be a separate Contract and no cancellation or termination of anyone Contract relating to an installment shall entitle the Customer to repudiate or cancel any other Contractor installment.
- v. The Customer shall take delivery of the Goods promptly whenever they are tendered for delivery (which shall include signing the relevant delivery note). If, for any reason, the Customer fails to take such delivery of the Goods or otherwise causes or requests a delay in delivery:
 - a. The Goods shall be deemed to have been delivered;
 - b. Risk in Goods shall pass to the Customer; and
 - c. The Company shall be entitled to store or arrange for the storage of the Goods until actual delivery, and charge the Customer for the reasonable costs (including insurance) of such storage and any additional charges incurred in delivering the Goods at a later date.
- vi. The Customer shall ensure that adequate and safe facilities and procedures exist at the Customer's premises for the delivery of the Goods.
- vii. The Customer shall immediately notify the Company's Customer Support Centre if the Goods are not received within 30 days of receipt of the invoice.

Acceptance of the Goods

- viii. Subject to condition 6.9, the Customer shall be deemed to have accepted the Goods seven days after the date of delivery to the Customer. After acceptance, the Customer shall not be entitled to reject Goods which are not in accordance with the terms of the Contract and the Company shall have no liability whatsoever to the customer in respect of the Goods.
- ix. The Customer must notify to the Company's Customer Support Centre any alleged defect, shortage in quantity, damage, loss or failure to comply with description within seven days of receipt and hold the Goods for inspection by the Company.

Return of the Goods

- x. Any requests to return Goods must be made to the Company's Customer Support Centre within seven days after the date of delivery of the Goods to the Customer. Goods which have specialist storage requirements or short expiry dates will not be accepted for return.
- xi. If the company agrees to accept any Goods for return, the Company will issue a "return reference number" and the Customer shall be liable to pay a handling charge of 20% of the price. No return will be accepted after 15 days. Custom-made, made to order, color-coded, etched, and specially sourced instruments are non-returnable. Instruments that have been used/sterilized are also non-returnable. All products being returned should be sent in their original unopened packaging. All Goods must be returned to the Company carriage-paid. The Customer must provide the Company with proof of carriage. For the avoidance of doubt, the Goods shall be at the Customer's risk until return delivery is accepted by the Company.
- xii. Goods returned without the prior written approval of the Company may be returned to the Customer at the absolute discretion of the Company.

Recall of the Goods

- xiii. In the event that any Goods are subject to be called by the Company, the Customer shall provide to the Company as much information as is reasonably possible regarding the whereabouts of the Goods.

7. Title and Risk

- i. The Goods shall be at the Customer's risk at the time of delivery, unless the parties have agreed in writing that the Goods are to be collected from the Company's premises, in which case, the Goods shall be at the Customer's risk when the Company notifies the Customer that the Goods are available for collection.
- ii. Property in the Goods shall not pass from the Company until:
 - a. The Customer has paid the price in full; and
 - b. No other sums whatsoever are due from the Customer to the Company.
- iii. Until property in the Goods passes to the Customer in accordance with the condition 7.2, the Customer shall:
 - a. Hold the Goods on a fiduciary basis as bailed for the Company;
 - b. Store the Goods separately from all other goods in its possession and mark them in such a way that they are clearly identified as the Company's property; and
 - b. Maintain the Goods in satisfactory condition and keep them insured on the Company's behalf for their full price.
- iv. The Customer may sell at full market value or use the Goods only in the ordinary course of the Customer's business. Any such sale or dealing shall be a sale or use of the Company's property on the Customer's own behalf and the Customer shall deal as principal when making such sales or dealings. Until property in the Goods passes from the Company, the proceeds of sale or otherwise of the Goods, to the full extent of the price of the Goods, shall be held in trust for the Company and shall not be mixed with other money or paid in to any over drawn bank account and shall be at all material times identified as the Company's money.
- v. The Company shall be entitled to recover the price notwithstanding that property in any of the Goods has not passed from the Company.
- vi. Until such time as property in the Goods passes from the Company, if the Customer:
 - a. Enters into liquidation or has a winding up order made against it or has an administrator, receiver or manager appointed in respect of its assets; or
 - b. Fail to make payment in accordance with these conditions, the Customer shall upon request deliver up to the Company such of the Goods as have not ceased to be in existence or resold. If the Customer fails to do so, the Company may enter upon any premises owned, occupied or controlled by the Customer where the Goods are situated and repossess the Goods.
- iv. The Customer shall indemnify the Company for any losses incurred by the Company in respect of any claim brought for:
 - a. Use of Goods by the Customer in breach of section 6 of the Health and Safety at Work Act etc 1974 or any other relevant safety legislation; or
 - b. Infringement of any patent, copyright or other third party intellectual rights relating to the Goods by the customer.

- vi. The Customer shall not pledge or in any way charge by way of security for any indebtedness, any of the Goods which are the property of the Company. If the Customer does so, all sums whatever owing by the Customer to the Company shall forth with become due and payable.
- vii. On termination of the Contract, howsoever caused, the Company's rights contained in this condition 7 shall remain in effect.

8. Warranties and Liability

- i. Subject as expressly provided in the Contract, all warranties, conditions or other terms implied by statute or common law are excluded to the fullest extent permitted by law.
- ii. Subject as expressly provided in the Contract, all terms and conditions, warranties and representations (whether implied or made expressly) whether by the Company, its servants or agents or otherwise relating to the quality and /or fitness for the purposes of the Goods are excluded to the fullest extent permitted by the law.
- iii. The Company shall be under no liability in respect of any damage arising from fair wear and tear. Fire or accident, will full damage, negligence, abnormal working conditions, failure to follow the Company's instructions. Misuse [or unauthorized installation, alteration or repair] of the Goods. The Customer must pass the Company's instructions on to any purchasers or potential users of the Goods.
- v. The Company shall not be liable to the Customer for any indirect or consequential losses (including indirect loss of profit, loss of use, loss of production, loss of business, loss of business opportunity, loss of business revenue and loss of good will) arising under or in connection with the Contract.
- vi. Subject to the condition 8.8, when any valid claim in respect of the Goods is notified to the Company in accordance with these conditions, the Company shall be entitled to repair or replace the Goods (or the part in question) or, at the Company's sole discretion, refund to the Customer the price of the Goods (or proportionate part of the price), and the Company shall have no further liability to the Customer.
- vii. Subject to the condition 8.8, the entire liability of the Company arising under or in connection with the performance of the Contract howsoever arising shall not exceed £5,000,000 (in line with the NHS Purchasing and Supply Agency conditions of contract for the purchase of goods).
- viii. Nothing in these conditions shall exclude or limit the liability of the Company for death or personal injury caused by the Company's negligence, fraud or fraudulent misrepresentation, or any other matter in relation to which it would be illegal for the Company to exclude or attempt to exclude its liability.

9. Force Majeure

- i. The Company shall not be responsible for any failure to fulfill its obligations under these conditions and/or in relation to the Goods if such failure is caused by an event which is beyond its reasonable control including acts of God, war, armed conflict, acts of terrorism, riot, strikes, industrial action (including action involving the Company's employees), fire, flood, any natural disaster, any defaults by the Company's suppliers or subcontractors, difficulties obtaining workmen or materials, and breakdown of machinery.
- ii. If such event continues for more than one month, the Company may terminate the Contract without liability.

10. Assignment

- i. The Company may assign the Contractor any part of it to any company, firm or organization.
- ii. The Customer shall not be entitled to assign the Contractor any part of it without the prior written consent of the Company (such consent not to be unreasonably withheld or delayed).

11. Export

- i. Where the Customer intends to export the Goods from the United Kingdom, the Customer shall be responsible for obtaining all necessary licenses and complying with all applicable legislation and regulations governing the export of the Goods from the United Kingdom and the importation of the Goods into the country of destination and shall be responsible for the payment of all duties on the Goods.

12. Miscellaneous

- i. All communications between the parties about the Contract shall be in writing and delivered by pre-paid first class post or by hand to the party's registered office, principal place of business or such other address as may at the relevant time have been notified pursuant to this provision to the party giving notice. In the absence of evidence of earlier receipt, any notices shall be deemed to be duly served:
 - a. If sent by first class post, two working days after posting; or
 - b. If delivered personally, when left at the relevant address.
- ii. Save as required to be disclosed by law:
 - a. Where the Customer is an NHS body, both parties, their employees and agents shall at all times keep confidential and secret and shall not disclose to any person the price or specification relating to the Goods (unless otherwise published); or
 - b. Where the Customer is not an NHS body, both parties, their employees and agents shall at all times keep confidential and secret and shall not disclose to any person any information, materials or documents acquired in connection with the Contract which concerns the other party, its employees or business, Unless otherwise disclosed other than due to a failure of the relevant party to comply with the Contract. On termination of the Contract, howsoever caused, the parties' obligations contained in this condition 12.2 shall remain in effect.
- iii. Neither party, its employees or agents shall offer, give or agree to give to any person any gift or consideration of any kind as an inducement or reward for doing or for bearing to do, or for having done or for borne to do, any action in relation to the obtaining or execution of any contract with the other party.
- iv. Each right or remedy of the Company under these conditions is without prejudice to any other right or remedy of the Company.
- v. On termination of the Contract, howsoever caused, all obligations which are expressed to remain in effect shall survive termination of the Contract, together with such conditions the survival of which is implied or is necessary for the interpretation or enforcement of the Contract.
- vi. A person who is not a party to the Contract shall have no rights pursuant to the Contracts (Rights of Third Parties) Act 1999 to enforce any terms of such contract.
- vii. If any provision of the Contract is held to be wholly or partly illegal, invalid, void, voidable, unenforceable or unreasonable it shall. To the extent of such illegality, invalidity, voidness, voidability, unenforceability or unreasonableness, be deemed to be severable and the remaining provisions of the Contract and the remainder of the provision shall continue in full force and effect.
- viii. No waiver or forbearance by the Company (whether express or implied) in enforcing any of its rights under these conditions shall prejudice its right to do so in the future.
- ix. These conditions are subject to the law of England and Wales. All disputes arising in relation to these conditions or the Contract shall be subject to the exclusive jurisdiction of the courts of England and Wales.

ALPHABETICAL INDEX



SURTEX
INSTRUMENTS

Crafted to Excellence

Alphabetical Index

A	Pages		B	Pages
Adson			Binder	
Dressing Forcep	123		Flap Separator & Elevator	58
Dissecting Forcep	124		Bishop-Harmon	
Agarwal			Anterior Chamber Irrigator	32
Karate Phaco Chopper	50		Iris Forcep 137	
Agricola,			Dressing Forcep	138
Lacrimal Sac Retractor	10		Blaydes	
AK			Lens Holding Forcep	156
Diamond Knife	19		Blumenthal	
Akahoshi			Conjunctiva Dissector	40
Nucleus Sustainer	47		Bonaccolto	
Phaco PreChopper	152		Conjunctival Forcep	149
Aker			Bonfadini	
Lens Pusher	62		DALK Spatula	43
Alfonso			Bonn	
Eye Speculum	2		Scleral Knife	11
Nucleus Irrigating Spoon	37		Micro Iris Hook	74
Nucleus Trisector	66		Corneal Forcep	133
Cutting Platform	68		Iris Scissor	96
Nucleus Grasping Forcep	152		Botvin	
Alio			Iris Forcep	130
LASIK Irrigation Cannula	33		Bowman	
MICS Scissor	121		Lacrimal Probe	179
MICS Capsulorrhexis Forcep	128		Bracken	
Alio-Kelman			Irrigation Cannula	33
IOL Hook	62		Braunstein	
Anis			Caliper	90
Nucleus Manipulator	56		Brierley	
Radial Marker	89		LASIK Cannula	35
Arruga			Nucleus Splitter	51
Micro Burr	17		Brown	
Capsule Forcep	151		Needle Holder	167
Atkinson			Bucher-Kansas	
Retrolubar Needle	30		Nucleus Trisector	66
Ayer			Bunge	
Chalazion Forcep	162		Evisceration Spoon	72
			Buratto	
			LASIK Cannula	35
			LASIK Flap Protector	40-41
			LASIK Flap Forcep	143
			IOL Inserting Forcep	155
B			C	
Backhaus			Camellin	
Towel Clamp	164		LASEK Trephine	25
Baird			Carter	
Chalazion Forcep	160		LASIK Cannula	34
Banaji			Sphere Introducer	71
LASIK Cannula	34		Castroviejo	
Bangerter			Eye Speculum	5
Eye Speculum	3		Synchia Spatula	63
Muscle Clamp	157		Cyclodialysis Spatula	92
Bard-Parker			Corneoscleral Scissor	108
Scalpel Handle	93		Universal Corneal Scissor	111
Barkan			Keratoplasty Scissor	112
Goniotomy Knife	15		Suture Tying Forcep	135-136
Barraquer			Capsule Forcep	151
Eye Speculum	1-2		Micro Needle Holder	168-169, 176-177
Iris Spatula	45		Caliper	178
Iris Scissor	107		Blade Holder/Breaker	94
Cilia Forcep	126		Castroviejo-Colibri	
Micro Needle Holder	171-175		Corneal Forcep	132
Blade Holder/Breaker	94		Chang	
Barraquer-Troutman			Hydrodissection Cannula	36
Micro Needle Holder	170		Phaco Chopper	49-50
Barrett			Charleux	
Nucleus Expressor	63		Cortex Extractor	36
Bechert			Chavasse	
Nucleus Rotator	54		Strabismus Hook	86
Lens Pusher	62			
Lens Holding Forcep	156			
Beer				
Cilia Forcep	126			
Berke				
Forcep	158			
Ptosis	158			

Alphabetical Index

C	Pages	E	Pages
Chayet		Elliot	
Corneal Marker	86	Scleral Trephine	25
Christensen		Ellis	
Punctum Punch	26	Foreign Body Spud	16
Citelli		Elschnig	
Mastoid Rongeur	165	Cyclodialysis Spatula	62
Clayman		Fixation Forcep	139
Nucleus Rotator	54	Enucleation	
Lens Holding Forcep	157	Scissor	101
Clayman-Jaffe		Erhardt	
Lens Manipulating Hook	75	Lid Forcep	159
Colibri		Ernest	
Corneal Forcep	130-131	Nucleus Cracker	152
Corbin		Escaf	
Sub Tenon's Anesthesia Cannula	30	Nucleus Manipulator	46
Cottle		Nucleus Sustainer	47
Bone Mallet	179	Nucleus Divider	52
Crawford			
Retrieval Hook	92	F	
Lacrimal Intubation Set	92	Faulkner	
Crescent		Lens Holding Forcep	155
Diamond Knife	21	Feaster	
Culler		Wire Speculum	1
Iris Spatula	44	Fechtner	
Lens Spoon	69	Trabeculectomy Marker	89
		Conjunctival Forcep	132
D		Fenzi	
DALK		Lens Manipulating Hook	79
Air Injection Cannula	28	Fine	
Corneal Dissector	43	Micro Scissor	115
Dastoor		Suture Tying Forcep	148
Gouge & Lacrimal Sac Dissector	11	Fine-Thornton	
Pupil and Iris Repositor	44	Fixation Ring	82
Erisophake (Bell)	72	Flieringa	
De La O		Fixation Ring	6
Aspirating Cannula	36	Foster	
Deitz		Enucleation Snare	71
ICL Manipulator	80	Francis	
Desmarres		Foreign Body Spud	16
Lid Retractor	8, 178	Chalazion Forcep	161
Chalazion Forcep	161	Franke	
Entropion Forcep	162	Eye Speculum	2
Dix		Friedman	
Foreign Spud & Gouge	17	Bone Rongeur	179
DLEK		Fukasaku	
Corneal Dissector	12	Hockey Knife	14
Dodick		Sub Tenon's Anesthesia Cannula	30
Nucleus Cracker	152	LASIK Cannula	34
IOL Folding Forcep	153	Hydro-Chop Cannula	36
Dodick-Kammann		Snapper Hook	52
Nucleus Chopper	51	Snapper Hook & Small Pupil	53
Double-X		LASIK Spatula 58	
Eye Speculum	5	Fukasaku-Lieberman	
Downes		Nucleus Manipulator and Hook 48	
Lid Clamp	160		
Drews			
Irrigation Vectis	36		
Drof			
Infusion Cannula	37		
Drysdale			
Nucleus Manipulator	55		

Alphabetical Index

G	Pages
Gass	
Scleral Marker	7
Corneoscleral Punch	26
Retinal Detachment Hook	84
Gerl	
Suture Tying Forcep	148
Giannetti	
Nucleus Capture Spoon	68
Nucleus Capture Spatula	68
Nucleus Capture Hook	69
Push Pull Manipulator	80
Gills	
Corneal Knife	14
Irrigating - Aspirating Cannula	31
Aspirating Cannula	36
Capsulotomy Scissor	119
Gills-Colibri	
Corneal Forcep	130
Gills-Vannas	
Capsulotomy Scissor	116-118
Gimbel	
Cortex Aspirating Cannula	35
Nucleus Spatula	45
Stabilization Ring	82
Girard	
Synechia Spatula	57
Corneoscleral Forcep	137
Gold	
Punctal Plug Forcep	150
Goldman-Fox	
Gum Scissor	95
Gonnin	
Amsler Marker	7
Gradle	
Ribbon Scissor	103
Cilia Forcep	149
Graefe	
Cataract Knife	13
Dressing Forcep	129
Dissecting Forcep	129
Fixation Forcep	139
Nerve Hook	178
Graether	
Collar Button	73
Grene	
Visual Axis Marker	87
Guimaraes	
LASIK Spatula	59

H	Pages
Halsted-Mosquito	
Haemostatic Forcep	163
Harms-Colibri	
Corneal Forcep	130
Harris-Sinsky	
Lens Manipulating Hook	75
Hartmann	
Haemostatic Forcep	163
Hartmann-Halle	
Nasal Speculum	166
Hebra	
Chalazion Curette	39
Helveston	
Tissue Retractor	9
Teaser Hook	84
Finder Hook	84
Muscle Hook	85
Scleral Ruler	89
Suture Tying Forcep	148

H	Pages
Hersh	
IntraLase Flap Spatula	58
Heslin	
Infusion Cannula	38
Hirschmann	
Lens Spatula	60
Iris Hook	76
Hoffer	
Optic Zone Marker	88
Hoffer-McPherson	
Tissue Forcep	135
Hofmann-Thornton	
Fixation Ring	83
Holland	
DALK Scissor	108, 117
Hoskin	
Tissue Forcep	131
Hunkeler	
IOL Manipulator	61
Hwang	
Phaco Chopper	5

I	Pages
ICL	
Lens Cartridge Loading Forcep	128
ILM	
Vitreotomy Scissor	127
Inamura	
Capsulorrhexis Forcep	145
Iris	
Scissor	95-97, 102
Micro Scissor	114

J	Pages
Jaeger	
Lid Plate	9
Keratome	11
Jaffe	
Lid Retractor	8
Lens Spatula	60
Lens Manipulating Hook	75
Stitch Scissor	114
Capsulorrhexis Forcep	145
Suture Tying Forcep	146
Utility Forcep	151
Jaffe-Bechert	
Nucleus Rotator	54
Jaffe-Maltzman	
Lens Manipulating Hook	80
Jameson	
Muscle Hook	85
Muscle Forcep	157-158
Jansen	
Capsule Polisher Cannula	32
Jones	
Towel Clamp	164
Joseph	
Mucus Hook	178

Alphabetical Index

K	Pages	L	Pages
Kansas		Lewis	
Lens Loop	65	Lens Loop	64
Nucleus Trisector	67	Lieberman	
Nucleus Bisector	67	Eye Speculum	4-5
Nucleus Vectis	67	Nucleus Manipulator	47
Katzen		Nucleus Manipulator and Spatula	48
LASIK Flap Spatula	59	Lippman	
Katzin		Nucleus Spatula	56
Corneal Transplant Scissor	110	Lister	
Kaye		Conjunctival Forcep	149
Ribbon Facelift Scissor	103	Utility Forcep	150
Kellen		Livernois	
Capsulorrhexis Marker	86	IOL Folding Forcep	153
Kelly		IOL Holding Forcep	154
Descemet's Membrane Punch	26	Livernois-McDonald	
Kelman		IOL Inserting Forcep	155
Cystotome	31	Lordan	
Kelman-McPherson		Chalazion Forcep	161
Tissue Forcep	134	LRI	
Suture Tying Forcep	143	Diamond Knife	18
Kerrison		Lu-Mendez	
Sphenoid Punch	165	Fixation Ring and Guide	82
Kilner		Luntz-Dodick	
Dissecting Scissor	95, 100	Trabeculectomy Punch	
Kirby			
Lens Loop and Muscle Hook	65	M	
Knapp		Maddox	
Wound Retractor	178	LASIK Spatula	59
Knolle		Maloney	
Anterior Chamber Irrigation Cannula	33	Intra-Operative Keratometer	86
Nucleus Spatula	46	Maltzman-Fenzl	
Knolle-Pearce		Lens Manipulating Hook	79
Irrigation Vectis	37	Manhattan	
Koch		Eye & Ear Fixation Forcep	139
Nucleus Spatula	46	Mannis-Buratto	
Kraff		LASIK Flap Protector	41
Capsule Tag Forcep	144	Manson	
Kratz		Strabismus Hook	83
Cystotome	32	Masket	
Lens Holding Forcep	156	Phaco Spatula	49
Kratz-Barraquer		Capsulorrhexis Forcep	145
Eye Speculum	1	McDonald	
Kuglen		Optic Zone Marker	87
Iris Hook and Lens Manipulator	77-78	McIntyre	
Kuhnt		Lacrimal Cannula	28
Corneal Scarifier	12	Cystotome	32
Kurstin		Anterior Chamber Cannula	35
Flap Stretching Forcep	143	McNeill-Goldman	
		Scleral Fixation Ring	6
L		McPherson	
Lacrimal		Suture Tying Forcep	134, 141-142
Cannula	28	Micro Needle Holder	167
Lambert		McPherson-Vannas	
Chalazion Forcep	160	Capsulotomy Scissor	117
Lancaster		McPherson-Westcott	
Eye Speculum	4	Conjunctival Scissor	112
LASEK		Stitch Scissor	113
Alcohol Cannula	30	Mead	
LASIK		Bone Rongeur	179
Flap Manipulator	60	Mellinger	
Lester		Eye Speculum	3
IOL Manipulator	61	Mendez	
Fixation Forcep	140	Degree Gauge	87
Lester-Burch		Multipurpose LASIK Forcep	144
Eye Speculum	4	Meyerhoefer	
Lewicky		Chalazion Curette	39
Lens Manipulating Hook	75	Micro	
		Viscocanalostomy Knife	15
		Scissor	106

Alphabetical Index

S	Pages	W	Pages
LASIK Epi-Dissector	43	Walter	
LASIK Flap Repositor	43	Cataract Needle	13
St. Martin's		Walton	
Suture Tying Forcep	138	Conjunctiva Retractor	9
Stahl		Foreign Body Gouge	16
Trabeculotomy Probe	90	Watzke	
Steinert		Sleeve Spreading Forcep	159
IOL Inserting Forcep	154	Wecker	
Stern-Castroviejo		Iris Scissor	107
Suture Tying Forcep	136	Wells	
Stern-Gills		Enucleation Spoon	72
Micro Scissor	119	Westcott	
Stevens		Tenotomy Scissor	112-113
Sub Tenon's Anesthesia Cannula	30	Stitch Scissor	114
Tenotomy Hook	83	Wheeler	
Tenotomy Scissor	97-98, 103, 122	Spatula	45
Stevenson		Wies	
Lacrimal Sac Retractor	10	Chalazion Forcep	161
Strabismus		Williams	
Scissor	99, 102	Eye Speculum	3
T		Williamson-Noble	
Tanna-Lieberman		Micro Scissor	104
Eye Speculum	4	Wills	
Tennant		Cautery	9
Nucleus Rotator	56	Wright	
Suture Tying Forcep	146-147	Fascia Needle	9
Thornton		Z	
Fixation Ring	83	Ziegler	
Tibolt		Cataract Knife	13
Punctal Scissor	113		
Tooke			
Corneal Knife	12		
Troutman			
Olive Tip Cannula	29		
Superior Rectus Forcep	140		
Micro Needle Holder	174		
Troutman-Castroviejo			
Corneoscleral Scissor	109		
Troutman-Katzin			
Corneal Transplant Scissor	110		
Troutman-Chris			
Blade Holder/Breaker	94		
U			
Utrata			
Capsulorrhexis Forcep	144		
V			
Vannas			
Capsulotomy Scissor	115-116		
Micro Scissor	122		
Vitrectomy			
Scissor	120		
Forcep	127		
Viscoelastic			
Aspirating Cannula	29		

Numerical Index

Cat. No.	Page	Cat. No.	Page	Cat. No.	Page	Cat. No.	Page
OP-010-10	1	OP-211-11	9	OP-359-22	24	OP-463-22	32
OP-010-15	1	OP-220-00	10	OP-370-10	25	OP-465-23	32
OP-012-15	1	OP-222-00	10	OP-370-15	25	OP-467-23	32
OP-020-10	1	OP-226-00	10	OP-370-20	25	OP-467-25	32
OP-020-15	1	OP-228-01	11	OP-370-90	25	OP-471-19	32
OP-022-20	1	OP-228-02	11	OP-381-08	25	OP-467-25	32
OP-030-13	1	OP-239-40	11	OP-381-09	25	OP-477-26	32
OP-030-15	1	OP-239-70	11	OP-381-10	25	OP-481-23	33
OP-032-15	1	OP-240-01	11	OP-385-08	25	OP-481-27	33
OP-040-10	2	OP-240-02	11	OP-385-09	25	OP-481-30	33
OP-042-00	2	OP-240-03	11	OP-385-10	25	OP-485-27	33
OP-046-00	2	OP-241-01	11	OP-391-00	26	OP-487-19	33
OP-050-09	2	OP-241-02	11	OP-395-00	26	OP-489-23	33
OP-060-08	2	OP-241-03	11	OP-397-00	26	OP-491-23	33
OP-060-11	2	OP-250-11	12	OP-399-00	26	OP-493-21	33
OP-060-15	2	OP-251-01	12	OP-400-01	27	OP-495-26	34
OP-064-12	3	OP-251-02	12	OP-400-02	27	OP-501-23	34
OP-064-15	3	OP-253-12	12	OP-400-03	27	OP-503-25	34
OP-070-15	3	OP-255-12	12	OP-400-04	27	OP-507-25	34
OP-072-02	3	OP-256-01	13	OP-400-05	27	OP-509-23	35
OP-074-11	3	OP-256-02	13	OP-400-06	27	OP-509-25	35
OP-074-15	3	OP-256-03	13	OP-400-07	27	OP-511-25	35
OP-076-16	4	OP-256-04	13	OP-400-08	27	OP-516-23	35
OP-078-00	4	OP-256-05	13	OP-400-09	27	OP-516-26	35
OP-081-15	4	OP-257-05	13	OP-400-10	27	OP-516-30	35
OP-083-10	4	OP-257-06	13	OP-400-11	27	OP-517-23	35
OP-083-15	4	OP-257-07	13	OP-400-12	27	OP-517-26	35
OP-083-15 A	4	OP-258-12	13	OP-400-13	27	OP-517-30	35
OP-085-15	4	OP-259-12	13	OP-400-14	27	OP-519-30	35
OP-087-10	5	OP-260-12	14	OP-401-01	27	OP-521-23	35
OP-087-15	5	OP-261-12	14	OP-401-02	27	OP-523-23	35
OP-089-15	5	OP-263-12	14	OP-401-03	27	OP-525-21	35
OP-089-15 A	5	OP-265-12	14	OP-401-04	27	OP-527-23	36
OP-091-14	5	OP-266-11	15	OP-401-05	27	OP-527-25	36
OP-091-16	5	OP-268-01	15	OP-401-06	27	OP-529-05	36
OP-095-04	5	OP-271-12	16	OP-401-07	27	OP-529-07	36
OP-100-00	6	OP-273-12	16	OP-401-08	27	OP-529-08	36
OP-100-14	6	OP-275-11	16	OP-401-09	27	OP-529-10	36
OP-100-15	6	OP-276-12	16	OP-401-10	27	OP-531-23	36
OP-100-16	6	OP-280-18	17	OP-401-11	27	OP-532-27	36
OP-100-17	6	OP-283-11	17	OP-401-12	27	OP-533-23	36
OP-100-18	6	OP-285-00	17	OP-401-13	27	OP-535-20	36
OP-100-19	6	OP-291-11	17	OP-410-23	28	OP-537-23	37
OP-100-20	6	OP-300-12	18	OP-410-27	28	OP-539-25	37
OP-100-21	6	OP-302-12	18	OP-411-23	28	OP-541-25	37
OP-100-22	6	OP-304-12	18	OP-411-27	28	OP-542-25	37
OP-111-15	6	OP-305-11	19	OP-412-23	28	OP-542-40	37
OP-111-16	6	OP-311-01	19	OP-413-23	28	OP-543-22	37
OP-111-17	6	OP-311-02	19	OP-415-23	28	OP-545-23	38
OP-151-01	7	OP-311-03	19	OP-417-27	28	OP-545-25	38
OP-153-01	7	OP-316-01	20	OP-419-27	28	OP-547-22	38
OP-153-02	7	OP-316-02	20	OP-421-27	28	OP-549-01 T	38
OP-153-03	7	OP-316-03	20	OP-421-30	28	OP-549-02 T	38
OP-160-14	7	OP-316-04	20	OP-423-27	28	OP-550-00	39
OP-163-00	7	OP-316-05	20	OP-423-30	28	OP-550-01	39
OP-171-15	7	OP-320-01	21	OP-427-19	29	OP-550-02	39
OP-172-01	8	OP-320-02	21	OP-427-21	29	OP-550-03	39
OP-172-02	8	OP-320-03	21	OP-429-19	29	OP-550-04	39
OP-172-03	8	OP-331-25	21	OP-429-22	29	OP-552-10	39
OP-173-13	8	OP-340-28	22	OP-433-25	29	OP-552-15	39
OP-173-15	8	OP-340-30	22	OP-437-27	29	OP-552-20	39
OP-175-11	8	OP-340-32	22	OP-437-30	29	OP-552-25	39
OP-175-17	8	OP-341-28	22	OP-439-25	30	OP-552-30	39
OP-175-15	8	OP-341-30	22	OP-441-19	30	OP-552-35	39
OP-175-17	8	OP-341-32	22	OP-443-23	30	OP-571-12	40
OP-180-01	8	OP-351-25	23	OP-445-23	30	OP-573-12	40
OP-180-02	8	OP-351-28	23	OP-447-24	30	OP-587-13	40
OP-192-11	9	OP-351-30	23	OP-451-23	31	OP-591-12	40
OP-197-14	9	OP-351-32	23	OP-453-23	31	OP-594-11	41
OP-199-14	9	OP-355-27	23	OP-455-23	31	OP-597-11	41
OP-201-12	9	OP-357-18	24	OP-457-23	31	OP-599-13	41
OP-211-07	9	OP-357-20	24	OP-459-23	31	OP-611-12	42
OP-211-09	9	OP-359-18	24	OP-462-22	31	OP-615-11	42

Numerical Index

Cat. No.	Page	Cat. No.	Page	Cat. No.	Page	Cat. No.	Page
OP-619-13	42	OP-735-12	62	OP-865-13	82	SL-100-11	93
OP-623-11	43	OP-738-12	62	OP-865-16	82	SL-100-15	93
OP-627-12	43	OP-739-11	62	OP-867-10	83	SL-206-10	93
OP-629-01	43	OP-741-13	62	OP-869-11	83	SL-206-13	93
OP-629-02	43	OP-743-13	63	OP-871-12	83	SL-206-15	93
OP-629-03	43	OP-745-25	63	OP-872-12	83	SL-210-61	93
OP-629-14	44	OP-745-50	63	OP-873-12	84	SL-210-62	93
OP-630-01	44	OP-749-12	63	OP-875-13	84	SL-210-63	93
OP-630-02	44	OP-750-01	64	OP-877-01	84	SL-210-64	93
OP-632-13	45	OP-750-02	64	OP-877-02	84	SL-210-65	93
OP-635-01	45	OP-752-13	64	OP-879-01	85	SL-210-66	93
OP-635-02	45	OP-754-13	64	OP-879-02	85	SL-210-67	93
OP-637-12	45	OP-757-15	65	OP-879-03	85	SL-210-68	93
OP-639-12	46	OP-758-14	65	OP-881-01	85	SL-210-69	93
OP-640-12	46	OP-760-13	65	OP-881-02	85	SL-900-09	94
OP-643-01	46	OP-761-13	66	OP-883-13	86	SL-901-09	94
OP-643-02	46	OP-765-10	66	OP-885-13	86	SL-910-11	94
OP-645-11	47	OP-767-10	66	OP-887-11	86	SL-916-13	94
OP-647-12	47	OP-769-11	67	OP-891-11	86	SS-243-12	95
OP-649-01	47	OP-771-11	67	OP-900-00	86	SS-243-15	95
OP-649-02	47	OP-773-12	67	OP-901-11	87	SS-400-13	95
OP-651-01	48	OP-775-02	68	OP-905-11	87	SS-400-13 SC	95
OP-651-02	48	OP-775-03	68	OP-907-11	87	SS-401-13	95
OP-653-01	48	OP-779-12	68	OP-911-01	88	SS-401-13 SC	95
OP-653-02	48	OP-781-12	68	OP-911-02	88	SS-430-09	95
OP-657-13	49	OP-783-12	69	OP-911-03	88	SS-430-10	95
OP-659-01	49	OP-790-13	69	OP-911-04	88	SS-431-09	95
OP-659-02	49	OP-793-14	69	OP-911-05	88	SS-431-10	95
OP-661-11	49	OP-795-04	70	OP-911-06	88	SS-434-09	96
OP-663-13	50	OP-795-05	70	OP-911-07	88	SS-435-09	96
OP-665-11	50	OP-796-00	71	OP-911-08	88	SS-440-11	96
OP-667-11	50	OP-798-00	71	OP-911-09	88	SS-441-11	96
OP-669-12	51	OP-798-90	71	OP-911-10	88	SS-440-11 SC	96
OP-670-15	51	OP-799-13	71	OP-911-11	88	SS-441-11 SC	96
OP-670-20	51	OP-800-01	72	OP-911-12	88	SS-446-12	97
OP-671-15	51	OP-800-02	72	OP-911-13	88	SS-447-12	97
OP-671-20	51	OP-802-15	72	OP-913-01	88	SS-450-10	97
OP-673-12	52	OP-803-00	72	OP-913-02	88	SS-450-11	97
OP-675-12	52	OP-804-12	73	OP-913-03	88	SS-451-10	97
OP-677-11	52	OP-805-12	73	OP-913-04	88	SS-451-11	97
OP-678-11	52	OP-811-11	73	OP-913-05	88	SS-450-11 SC	97
OP-679-11	52	OP-813-11	74	OP-913-06	88	SS-451-11 SC	97
OP-681-11	53	OP-815-12	74	OP-913-07	88	SS-452-10	98
OP-683-11	53	OP-817-12	74	OP-913-08	88	SS-452-11	98
OP-685-11	53	OP-819-01	75	OP-913-09	88	SS-452-12	98
OP-687-13	53	OP-819-02	75	OP-913-10	88	SS-452-11 SC	98
OP-689-01	54	OP-821-01	75	OP-913-11	88	SS-453-10	98
OP-689-02	54	OP-821-02	75	OP-913-12	88	SS-453-11	98
OP-691-11	54	OP-823-12	75	OP-913-13	88	SS-453-12	98
OP-693-11	55	OP-825-11	76	OP-915-08	89	SS-456-11	99
OP-695-11	55	OP-826-01	76	OP-915-12	89	SS-457-11	99
OP-697-11	55	OP-826-02	76	OP-915-16	89	SS-456-11 SC	99
OP-699-11	55	OP-826-03	77	OP-917-10	89	SS-457-11 SC	99
OP-700-12	56	OP-826-04	77	OP-919-09	89	SS-461-11	100
OP-701-12	56	OP-827-01	77	OP-930-12	89	SS-466-11	100
OP-703-12	56	OP-827-02	77	OP-932-01	90	SS-469-11	101
OP-705-11	56	OP-829-01	78	OP-932-02	90	SS-484-09	102
OP-707-11	57	OP-831-12	78	OP-934-30	90	SS-486-09	102
OP-709-12	57	OP-833-12	78	OP-934-35	90	SS-487-09	102
OP-711-13	57	OP-835-01	79	OP-935-01	90	SS-488-10	102
OP-713-14	58	OP-835-02	79	OP-941-01	90	SS-489-10	102
OP-715-13	58	OP-837-01	79	OP-941-02	90	SS-492-10	102
OP-717-12	58	OP-837-02	79	OP-944-08	91	SS-493-10	102
OP-719-12	59	OP-839-02	80	OP-946-10	91	SS-496-10	103
OP-720-13	59	OP-841-01	80	OP-948-01	91	SS-497-10	103
OP-723-12	59	OP-843-02	80	OP-948-02	91	SS-498-10	103
OP-725-11	60	OP-845-01	81	OP-948-03	91	SS-499-10	103
OP-726-11	60	OP-845-02	81	OP-950-14	92	SS-500-10	103
OP-727-12	60	OP-849-01	81	OP-953-14	92	SS-501-10	103
OP-728-12	61	OP-849-02	81	OP-956-14	92	SS-507-11	103
OP-729-12	61	OP-851-09	81	OP-960-00	92	SS-626-01	104
OP-731-11	61	OP-861-11	82	SL-010-03	93	SS-630-12	104
OP-733-12	61	OP-863-11	82	SL-012-03	93	SS-631-12	104

Numerical Index

Cat. No.	Page	Cat. No.	Page	Cat. No.	Page	Cat. No.	Page
SS-632-12	105	SS-974-10	122	FR-768-09	139	FR-901-02	157
SS-633-12	105	SS-975-10	122	FR-770-11	139	FR-903-01	158
SS-634-12	105	FR-050-12	123	FR-772-01	139	FR-903-02	158
SS-635-12	105	FR-050-15	123	FR-772-02	139	FR-905-20	158
SS-636-12	106	FR-050-18	123	FR-774-10	140	FR-905-27	158
SS-637-12	106	FR-052-12	123	FR-774-11	140	FR-906-10	159
SS-641-11	107	FR-054-12	124	FR-776-01	140	FR-907-11	159
SS-643-11	107	FR-054-15	124	FR-776-02	140	FR-908-10	159
SS-645-11	107	FR-250-12	124	FR-777-01	141	FR-910-09	160
SS-647-05	107	FR-250-15	124	FR-777-02	141	FR-912-08	160
SS-647-07	107	FR-250-18	124	FR-780-10	141	FR-912-12	160
SS-647-10	107	FR-252-12	125	FR-780-10 T	141	FR-914-09	160
SS-649-01	108	FR-253-12	125	FR-781-10	142	FR-916-09	161
SS-649-02	108	FR-256-12	125	FR-781-10 T	142	FR-918-09	161
SS-651-01	108	FR-256-15	125	FR-784-10	143	FR-919-09	161
SS-651-02	108	FR-630-09	126	FR-784-10 T	143	FR-920-09	161
SS-653-01	108	FR-632-10	126	FR-790-10	143	FR-921-09	161
SS-653-02	108	FR-680-20	127	FR-793-10	143	FR-922-01	162
SS-655-01	109	FR-680-23	127	FR-795-10	144	FR-923-01	162
SS-655-02	109	FR-682-20	127	FR-797-10	144	FR-923-02	162
SS-657-01	109	FR-682-23	127	FR-801-10	144	AF-062-03	163
SS-657-02	109	FR-685-20	127	FR-801-10 T	144	AF-063-03	163
SS-659-01	110	FR-687-20	127	FR-803-10	145	AF-140-10	163
SS-659-02	110	FR-689-23	127	FR-805-10	145	AF-141-10	163
SS-661-01	110	FR-690-23	127	FR-807-11	145	AF-160-12	163
SS-661-02	110	FR-692-20	128	FR-809-10	145	AF-161-12	163
SS-663-11	111	FR-695-23	128	FR-810-10	146	AF-170-10	163
SS-665-11	111	FR-700-01	129	FR-811-10	146	AF-171-10	163
SS-667-11	111	FR-700-02	129	FR-816-10	146	AF-172-10	163
SS-669-11	111	FR-700-03	129	FR-816-10 T	146	AF-173-10	163
SS-671-11	112	FR-702-01	129	FR-817-10	147	AF-761-05	164
SS-673-11	112	FR-702-02	129	FR-817-10 T	147	AF-761-09	164
SS-675-11	112	FR-702-03	129	FR-820-10	147	AF-773-08	164
SS-677-01	113	FR-710-07	130	FR-821-10	147	OT-751-02	165
SS-677-02	113	FR-712-07	130	FR-824-10	148	OT-751-03	165
SS-679-11	113	FR-714-07	130	FR-825-10	148	RH-305-03	165
SS-681-11	113	FR-716-07	130	FR-827-08	148	RH-305-04	165
SS-683-11	114	FR-718-07	130	R-827-08 T	148	RH-305-05	165
SS-685-11	114	FR-718-07 T	130	FR-830-10	149	RH-305-06	165
SS-688-11	114	FR-720-07	131	FR-834-12	149	RH-033-01	166
SS-689-11	114	FR-721-07	131	FR-834-17	149	RH-033-02	166
SS-690-11	115	FR-722-08	131	FR-836-10	149	RH-033-03	166
SS-691-11	115	FR-723-08	131	FR-838-10	149	RH-475-18	166
SS-694-08	115	FR-724-10	132	FR-840-10	150	RH-600-16	166
SS-695-08	115	FR-726-11	132	FR-842-10	150	RH-601-16	166
SS-696-08	116	FR-728-11	132	FR-844-11	150	RH-604-16	166
SS-697-08	116	FR-730-08	133	FR-847-08	150	RH-605-16	166
SS-698-08	116	FR-732-10	133	FR-846-10	150	SU-040-13	167
SS-699-08	116	FR-732-10 T	133	FR-848-11	151	SU-200-10	167
SS-701-08	117	FR-734-08	133	FR-850-11	151	SU-201-10	167
SS-703-08	117	FR-736-10	134	FR-855-11	151	SU-202-10	167
SS-705-08	117	FR-737-10	134	FR-857-11	151	SU-203-10	167
SS-706-10	118	FR-740-10	134	FR-859-11	151	SU-210-14	168
SS-707-10	118	FR-742-10	135	FR-861-11	152	SU-211-14	168
SS-709-10	118	FR-750-01	135	FR-863-11	152	SU-212-14	168
SS-710-11	119	FR-750-03	135	FR-867-11	152	SU-213-14	168
SS-711-11	119	FR-750-05	135	FR-869-10	152	SU-220-14	169
SS-713-11	119	FR-750-09	135	FR-871-11	153	SU-221-14	169
SS-715-11	119	FR-750-01 T	135	FR-875-11	153	SU-222-14	169
SS-720-20	120	FR-751-01	136	FR-877-10	153	SU-223-14	169
SS-721-20	120	FR-751-03	136	FR-879-10	154	SU-300-10	170
SS-721-23	120	FR-751-05	136	FR-882-10	154	SU-301-10	170
SS-721-30	120	FR-751-09	136	FR-883-10	154	SU-310-10	170
SS-721-45	120	FR-751-01 T	136	FR-885-10	155	SU-310-11	170
SS-723-23	120	FR-752-05	136	FR-887-10	155	SU-311-10	170
SS-723-60	120	FR-754-10	137	FR-889-10	155	SU-311-11	170
SS-723-80	120	FR-756-10	137	FR-891-12	156	SU-313-11	171
SS-725-23	121	FR-758-08	137	FR-893-12	156	SU-315-11	171
SS-726-12	122	FR-760-08	137	FR-895-11	156	SU-315-11 T	171
SS-727-12	122	FR-762-09	138	FR-897-12	156	SU-320-13	172
SS-729-12	122	FR-764-09	138	FR-899-12	157	SU-321-13	172
SS-972-10	122	FR-765-09	138	FR-900-10	157	SU-322-13	172
SS-973-10	122	FR-766-09	138	FR-901-01	157	SU-323-13	172

Numerical Index

Cat. No.	Page
SU-331-14	173
SU-331-14 T	173
SU-333-14	173
SU-333-14 T	174
SU-341-12	174
SU-343-12	174
SU-500-13	175
SU-502-13	175
SU-510-14	176
SU-511-14	176
SU-512-14	177
SU-513-14	177
DI-850-20	178
DI-880-15	178
RT-048-01	178
RT-048-02	178
RT-048-03	178
RT-066-13	178
RT-068-13	178
RT-074-02	178
RT-074-05	178
RT-074-07	178
RT-074-10	178
RT-120-08	178
RT-120-10	178
RT-120-12	178
RT-120-14	178
OR-470-19	179
OR-933-01	179
OR-934-02	179
OR-937-16	179
PR-200-00	179
ST-110-01	180
ST-110-02	180
ST-110-03	180
ST-112-26	180



COPYRIGHT NOTICE

The copyright, trademarks, domain names and other intellectual property rights in all materials and information in this presentation belongs to Surtex Instruments Ltd. All rights are reserved. Technical alterations are possible. This presentation may be used for no other purpose than offering, buying and selling of Surtex Instruments products. No part may be reproduced or copied in any form. In the event of misuse we retain the right to recall our catalogues and take appropriate legal action.

DISCLAIMER

This documents provides general information about Surtex Instruments Ltd, its products and services, and summarises general capabilities and offerings, which we deem to be relevant to our customers. Whilst Surtex Instruments has taken appropriate steps to ensure the accuracy of the information contained in the document Surtex Instruments gives no warranty regarding the accuracy or completeness of such information.

The presentation was prepared to provide information and does not constitute a contract. Surtex reserves the right, without prior notice, to change, delete, supplement, or otherwise amend at any time the information, images and offerings contained in the presentation or other documents. Surtex shall not be liable for any loss or damage of whatever nature (whether direct, indirect, consequential or other) may arise as a result of any third party relying on the information contained in this document.

For further detailed information, prices, terms and conditions, customer should contact Surtex Instruments at sales@surtex-instruments.co.uk.



Unit 202 Kingspark Business Centre
152-178 Kingston Road, New Malden
Surrey KT3 3ST United Kingdom
Phone: +44 (0) 208 123 3513

E-mail: sales@surtex-instruments.co.uk
Website: www.surtex-instruments.co.uk



A member of the ABHI



Association of
British HealthTech
Industries

Health Tech **For Life**